

















# CATALOGUE

TOOLS | MATERIALS | EQUIPMENT

<p>MATERIALS</p> 	<p>KITS &amp; COMPONENTS</p> 	<p>CONSUMABLES</p> 	<p>FIXINGS &amp; IRONMONGERY</p> 
<p>HAND TOOLS</p> 	<p>VOCATIONAL STUDIES</p> 	<p>WORKHOLDING</p> 	<p>WORKPLACE EQUIPMENT</p> 
<p>CUTTING TOOLS</p> 	<p>MACHINES &amp; POWER TOOLS</p> 	<p>ART</p> 	<p>TEXTILES &amp; HABERDASHERY</p> 
<p>GRAPHICS</p> 	<p>STATIONERY</p> 	<p>FOOD TECHNOLOGY</p> 	<p>STORAGE</p> 

ISSUE 58

# 2023/24

## Why choose Tilgear?



**Large stock holding**  
Stock availability is our priority



**Volume discounts**  
Take advantage of our bulk rates and regular promotions



**Prompt despatch**  
Next day delivery available



**Friendly, helpful staff**  
We're here to help you



# Welcome

The 58th edition of our annual catalogue is here, packed with a vastly increased range of tools, materials and equipment for educational and training establishments.



### How to Order

All educational establishments are set up at Tilgear with an **automatic credit account**, so ordering is simple and straightforward.

Orders can be posted, faxed, phoned, emailed or placed on-line. If your establishment requires an official purchase number please include this on the order.

- 1 Identify the item by the product code  
9 digit code shown in the pricing table
- 2 Indicate the quantity required  
Remember there are bulk rates on selected items
- 3 Add the carriage charge according to the value  
Free over £100.00 – except machinery

### Carriage Charges

- Orders over £100.00 exc. VAT:  
**Free** of charge
- Orders under £100.00 exc. VAT:  
**£7.95+ VAT**
- Channel Islands and Northern Ireland:  
**£11.95**
- For other destinations:  
please contact us for a quote.

### Export Orders

For many years we have been supplying educational establishments worldwide, particularly those using the English curriculum. Export customers are offered the products on the same pricing structure but the freight cost require a specific quote – please contact us by email.  
[export@toolsforschoolsinternationl.com](mailto:export@toolsforschoolsinternationl.com)

*All prices shown are £ sterling and exclusive of VAT.*

### Order with Confidence

All goods are carefully selected by us and we are sure you will be satisfied with any purchase. However, if an item is not what you expect or require we will happily refund the purchase price. This only applies if the goods are returned carriage paid and unused within 21 days of delivery. (Does not apply to items specifically ordered).

**Current Prices:** Prices shown are current 1st September 2023 and will be maintained until a new catalogue is issued. We reserve the right, in exceptional circumstances, to increase the price of certain items if required. VAT is extra on all prices, except books which are zero rated.

**Stock Availability:** We endeavour to hold in stock almost everything shown in our catalogue, with the exception of very few heavy or specially ordered items. However, in instances where a particular item is temporarily out of stock, it will be placed on back-order and despatched when available.

## Contact us

T 01920 824770  
F 01920 824773  
E [sales@tilgear.info](mailto:sales@tilgear.info)

[www.tilgear.info](http://www.tilgear.info)

**Materials**

Plastic Materials	5-21
Wooden Materials	22-25
Wooden Craft Parts	24-25
Metal Materials	26-27
Smart Materials	27

**Kits & Components**

Construction Kits	29-31
Environmental Meters	32
Components	33-43
Batteries	44

**Consumables**

Sharpening	46
Abrasives & Polishing	47-52
Soldering	52-54
Adhesives	55-59
Finishes	60-64
Lubricants & Pumps	65

**Fixings & Ironmongery**

Fixings	67-70
Hinges	71
Ironmongery	72
Assortment Boxes	72-74
Dowels	74
Staplers	74

**Hand Tools**

Measuring and Inspection	76-84
Carpentry	84-94
Woodcarving	94-97
Knives	97-99
Files & Rasps	100-102
Screwdrivers, Socket Sets & Spanners	103-107
Pliers & Metal Cutters	107-110
Hammers, Mallets & Punches	110-115

**Vocational Studies**

General Construction	117-118
Brickwork	119-125
Plastering	125-127
Tiling	128
Painting & Decorating	129-135
Plumbing	136-151
Electrical	152-161
Welding	162-164
Blacksmith & Forging	165

**Workholding**

Clamps	167-170
Vices	170-172
Clamping Accessories	170, 172

**Workplace Equipment**

Magnets & Lights	174
Extension Leads	175
Workwear & PPE	176-180
Signs & First Aid	181
Trolleys & Stops	182

**Cutting Tools**

Milling & Turning Equipment	184-188
Threading, Reaming & Drilling	189-195
Saw Blades	196-200
Router Cutters	200-204

**Machines & Power Tools**

Power Tools	206-210
3D Printers	211
Laser Cutters, Cutting Plotters, Scanners & Engravers	212-215
CNC Equipment	217
Extraction	218-222
Plastics Machinery	223-227
Workshop Machinery	228-246

**Art**

Sketchbooks	248-251
Paper & Card	248-253
Paint	254-258
Brushes	259-260
Art Sundries	260-261
Pottery	262-263
Enamelling	263
Airbrush Equipment	263
Lino Printing	264-265
Modelling	265-269
Drying Racks	269

**Textiles & Haberdashery**

Sewing Machines	271
Haberdashery	271-272
Textiles	272

**Graphics**

Trimmers	274
Drawing Equipment	275-277
Pens & Pencils	277-279
Sublimation	280

**Stationery**

Pens	282
Sharpeners, Erasers and Scissors	283
Drawing Equipment	284-285
Office Consumables	285-287

**Food Technology**

Janitorial Supplies & Safety Products	289-290
Food Preparation & Baking	291-292
Small Appliances & Food Storage	292-293
Utensils, Tableware & Cookware	294-296

**Storage & Furniture**

Boxes & Racks	298-299
Storage & Seating	299-305
Lockers	305
Benches	306-309
Cupboards & Drawers	310-312
Wall Bins & Adjustable Benches	313-314
Metal Benches & Hop-ups	315
Access Equipment	316

**Index**

Index	318-322
-------	---------

**Installations, Servicing & Compliance**

Installations	323
Servicing	323
Compliance	323



# Materials

---

**Plastic Materials**  
5-21

---

**Wooden Materials**  
22-25

---

**Wooden Craft Parts**  
24-25

---

**Metal Materials**  
26-27

---

**Smart Materials**  
27

TILGEAR

2023/24 ISSUE 58

## Standard Cast Acrylic Sheets

- Popular range of laserable acrylic sheets in 3mm thickness.
- Can be engraved/cut by CNC or Laser, thermoformed and blow moulded.
- High quality imported acrylic which has been tried and tested - highly recommended.



### Clear Cast Acrylic Sheet

CODE	Size	Thickness	Unit	4+	1+
ASH640CLR	600 x 400mm	3mm	1	<b>4.50</b>	5.05
ASH106CLR	1000 x 600mm	3mm	1	<b>10.95</b>	12.30

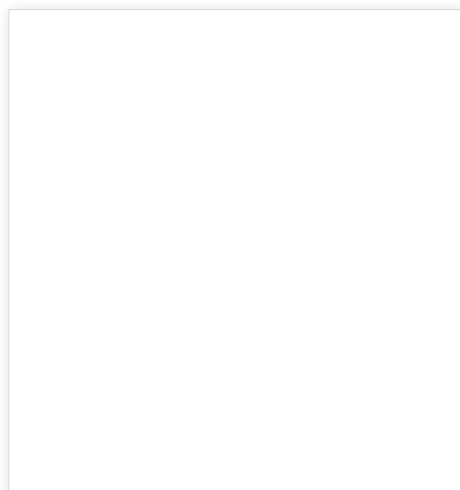

### White Cast Acrylic Sheet

CODE	Size	Thickness	Unit	4+	1+
ASH640WHT	600 x 400mm	3mm	1	<b>4.95</b>	5.55
ASH106WHT	1000 x 600mm	3mm	1	<b>11.95</b>	14.55

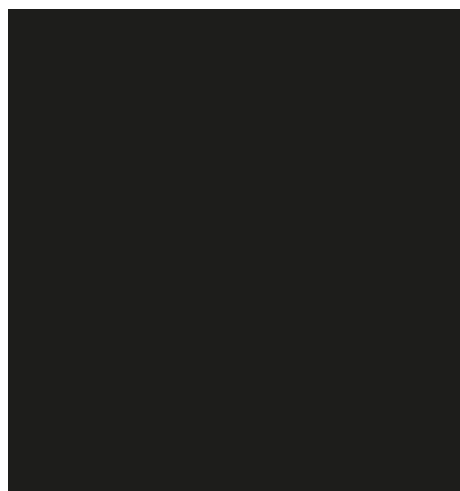

### Black Cast Acrylic Sheet

CODE	Size	Thickness	Unit	4+	1+
ASH640BLK	600 x 400mm	3mm	1	<b>4.95</b>	5.55
ASH106BLK	1000 x 600mm	3mm	1	<b>11.95</b>	14.55



### Red Cast Acrylic Sheet

CODE	Size	Thickness	Unit	4+	1+
ASH640RED	600 x 400mm	3mm	1	<b>4.95</b>	5.55



### Blue Cast Acrylic Sheet

CODE	Size	Thickness	Unit	4+	1+
ASH640BLU	600 x 400mm	3mm	1	<b>4.95</b>	5.55



### Yellow Cast Acrylic Sheet

CODE	Size	Thickness	Unit	4+	1+
ASH640YEL	600 x 400mm	3mm	1	<b>4.95</b>	5.55



### Hot Pink Cast Acrylic Sheet

CODE	Size	Thickness	Unit	4+	1+
ASH640HPK	600 x 400mm	3mm	1	<b>4.95</b>	5.55



### Orange Cast Acrylic Sheet

CODE	Size	Thickness	Unit	4+	1+
ASH640ORG	600 x 400mm	3mm	1	<b>4.95</b>	5.55



### Lime Green Cast Acrylic Sheet

CODE	Size	Thickness	Unit	4+	1+
ASH640LGR	600 x 400mm	3mm	1	<b>4.95</b>	5.55



### Dove Grey Cast Acrylic Sheet

CODE	Size	Thickness	Unit	4+	1+
ASH640DGY	600 x 400mm	3mm	1	<b>4.95</b>	5.55



### Green Cast Acrylic Sheet

CODE	Size	Thickness	Unit	4+	1+
ASH640GRN	600 x 400mm	3mm	1	<b>4.95</b>	5.55

Cast Acrylic Sheets

## Clear Standard Cast Acrylic Pack of 5

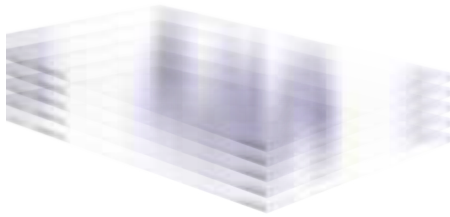

- Quality 3mm clear cast acrylic sheet in a bulk pack.
- Suitable for laser cutting, thermoforming and machining.

CODE	Size	Thickness	Unit	1+
ASH564CST	600 x 400mm	3mm	Pack of 5	21.95

## Assorted Standard Cast Acrylic Pack of 10



- Quality 3mm cast acrylic sheet in an assorted pack
- Suitable for laser cutting, thermoforming and machining.
- Black, Blue, Dove Grey, Green, Hot Pink, Lime Green, Orange, Red, White, Yellow

CODE	Size	Thickness	Unit	1+
ASH610SST	600 x 400mm	3mm	Pack of 10	47.95

## Iridescent Rainbow Cast Acrylic Sheet



- Iridescent cast acrylic sheet producing a rainbow spectrum of colours.
- A transparent sheet with a mirrored reflective coating.
- Suitable for laser cutting, CNC machining, thermoforming by line benders or blow moulding.

CODE	Size	Thickness	Unit	4+	1+
ACR640RBW	600 x 400mm	3mm	1	12.95	14.50

## Glitter Cast Acrylic Sheets

- A high quality cast acrylic sheet with a vibrant effect showing on both sides.
- The transparent coloured sheet is filled with glitter particles (larger than the sparkle), so rather than tinted it's nearly opaque.
- Suitable for laser cutting, CNC machining, thermoforming by line benders or blow moulding.



### Blue Glitter Cast Acrylic Sheet

CODE	Size	Thickness	Unit	4+	1+
ACR640GBU	600 x 400mm	3mm	1	11.75	12.95



### Gold Glitter Cast Acrylic Sheet

CODE	Size	Thickness	Unit	4+	1+
ACR640GGL	600 x 400mm	3mm	1	11.75	12.95



### Red Glitter Cast Acrylic Sheet

CODE	Size	Thickness	Unit	4+	1+
ACR640GRD	600 x 400mm	3mm	1	11.75	12.95



### Silver Glitter Cast Acrylic Sheet

CODE	Size	Thickness	Unit	4+	1+
ACR640GSV	600 x 400mm	3mm	1	11.75	12.95

## Recycled Cast Acrylic Sheets

- A premium quality cast acrylic sheet produced from 100% recycled methyl methacrylate monomer.
- Reduction of carbon foot-print and waste from sheet production.
- Increasing the life-cycle of cast acrylic and respect for the environment and our planet.
- Same mechanical and physical properties as virgin cast acrylic sheets.



### Clear Recycled Cast Acrylic Sheet

CODE	Size	Thickness	Unit	4+	1+
ACR640RCL	600 x 400mm	3mm	1	5.25	5.50



### Opal Recycled Cast Acrylic Sheet

CODE	Size	Thickness	Unit	4+	1+
ACR640ROP	600 x 400mm	3mm	1	6.50	6.95



### White Recycled Cast Acrylic Sheet

CODE	Size	Thickness	Unit	4+	1+
ACR640RWH	600 x 400mm	3mm	1	6.95	7.50

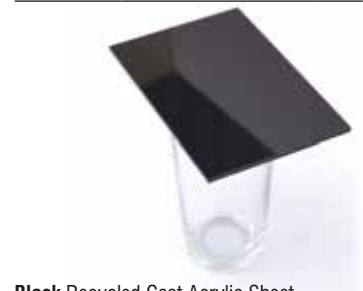

### Black Recycled Cast Acrylic Sheet

CODE	Size	Thickness	Unit	4+	1+
ACR640RBK	600 x 400mm	3mm	1	6.95	7.50



## Coloured Cast Acrylic Sheets

- High quality 3mm and 5mm cast sheet.
- Ideally suited for laser cutting, CNC machining, thermoforming by line benders or blow moulding.
- Supplied in three common sizes 1000 x 600mm, 1000 x 500mm and 600 x 400mm.



**Royal Blue Cast Acrylic Sheet**

CODE	Size mm	Thickness	Unit	4+	1+
ACR640SBU	600 x 400	3mm	1	<b>5.95</b>	6.25
ACR105SBU	1000 x 500	3mm	1	<b>12.50</b>	12.95
ACR564SBU	600 x 400	5mm	1	<b>11.95</b>	12.50
ACR106SBU	1000 x 600	3mm	1	<b>14.95</b>	15.50
ACR515SBU	1000 x 500	5mm	1	<b>23.75</b>	24.50



**Dark Green Cast Acrylic Sheet**

CODE	Size mm	Thickness	Unit	4+	1+
ACR640SGR	600 x 400	3mm	1	<b>5.95</b>	6.25
ACR105SGR	1000 x 500	3mm	1	<b>12.50</b>	12.95
ACR106SGR	1000 x 600	3mm	1	<b>14.95</b>	15.50



**Black Cast Acrylic Sheet**

CODE	Size mm	Thickness	Unit	4+	1+
ACR640SBK	600 x 400	3mm	1	<b>5.95</b>	6.25
ACR564SBK	600 x 400	5mm	1	<b>11.95</b>	12.50
ACR105SBK	1000 x 500	3mm	1	<b>12.50</b>	12.95
ACR106SBK	1000 x 600	3mm	1	<b>14.95</b>	15.50
ACR515SBK	1000 x 500	5mm	1	<b>23.75</b>	24.50



**Flame Red Cast Acrylic Sheet**

CODE	Size mm	Thickness	Unit	4+	1+
ACR640SRF	600 x 400	3mm	1	<b>5.95</b>	6.25
ACR105SRF	1000 x 500	3mm	1	<b>12.50</b>	12.95
ACR106SRF	1000 x 600	3mm	1	<b>14.95</b>	15.50



**Lime Green Cast Acrylic Sheet**

CODE	Size mm	Thickness	Unit	4+	1+
ACR640SGL	600 x 400	3mm	1	<b>5.95</b>	6.25
ACR564SGL	600 x 400	5mm	1	<b>11.95</b>	12.50
ACR105SGL	1000 x 500	3mm	1	<b>12.50</b>	12.95
ACR106SGL	1000 x 600	3mm	1	<b>14.95</b>	15.50
ACR515SGL	1000 x 500	5mm	1	<b>23.75</b>	24.50



**White Cast Acrylic Sheet**

CODE	Size mm	Thickness	Unit	4+	1+
ACR640SWH	600 x 400	3mm	1	<b>5.95</b>	6.25
ACR564SWH	600 x 400	5mm	1	<b>11.95</b>	12.50
ACR105SWH	1000 x 500	3mm	1	<b>12.50</b>	12.95
ACR106SWH	1000 x 600	3mm	1	<b>14.95</b>	15.50
ACR515SWH	1000 x 500	5mm	1	<b>23.75</b>	24.50



**Classic Red Cast Acrylic Sheet**

CODE	Size mm	Thickness	Unit	4+	1+
ACR640SRC	600 x 400	3mm	1	<b>5.95</b>	6.25
ACR105SRC	1000 x 500	3mm	1	<b>12.50</b>	12.95
ACR564SRC	600 x 400	5mm	1	<b>11.95</b>	12.50
ACR106SRC	1000 x 600	3mm	1	<b>14.95</b>	15.50
ACR515SRC	1000 x 500	5mm	1	<b>23.75</b>	24.50



**Yellow Cast Acrylic Sheet**

CODE	Size mm	Thickness	Unit	4+	1+
ACR640SYL	600 x 400	3mm	1	<b>5.95</b>	6.25
ACR564SYL	600 x 400	5mm	1	<b>11.95</b>	12.50
ACR105SYL	1000 x 500	3mm	1	<b>12.50</b>	12.95
ACR106SYL	1000 x 600	3mm	1	<b>14.95</b>	15.50
ACR515SYL	1000 x 500	5mm	1	<b>23.75</b>	24.50



**Orange Cast Acrylic Sheet**

CODE	Size mm	Thickness	Unit	4+	1+
ACR640SOR	600 x 400	3mm	1	<b>5.95</b>	6.25
ACR564SOR	600 x 400	5mm	1	<b>11.95</b>	12.50
ACR105SOR	1000 x 500	3mm	1	<b>12.50</b>	12.95
ACR106SOR	1000 x 600	3mm	1	<b>14.95</b>	15.50
ACR515SOR	1000 x 500	5mm	1	<b>23.75</b>	24.50

## Coloured Cast Acrylic Sheets

*continued*



**Mid Blue** Cast Acrylic Sheet

CODE	Size mm	Thickness	Unit	4+	1+
ACR640SMB	600 x 400	3mm	1	<b>5.95</b>	6.25
ACR105SMB	1000 x 500	3mm	1	<b>12.50</b>	12.95
ACR106SMB	1000 x 600	3mm	1	<b>14.95</b>	15.50



**Light Grey** Cast Acrylic Sheet

CODE	Size mm	Thickness	Unit	4+	1+
ACR640SGY	600 x 400	3mm	1	<b>5.95</b>	6.25
ACR105SGY	1000 x 500	3mm	1	<b>12.50</b>	12.95
ACR106SGY	1000 x 600	3mm	1	<b>14.95</b>	15.50



**Dark Grey** Cast Acrylic Sheet

CODE	Size mm	Thickness	Unit	4+	1+
ACR640SDG	600 x 400	3mm	1	<b>5.95</b>	6.25
ACR105SDG	1000 x 500	3mm	1	<b>12.50</b>	12.95
ACR106SDG	1000 x 600	3mm	1	<b>14.95</b>	15.50

## Special Effect Matt Cast Acrylic Sheets

- Matt on one side.



**Baby Pink** Cast Acrylic Sheet

CODE	Size mm	Thickness	Unit	4+	1+
ACR640SPK	600 x 400	3mm	1	<b>5.95</b>	6.25
ACR105SPK	1000 x 500	3mm	1	<b>12.50</b>	12.95
ACR106SPK	1000 x 600	3mm	1	<b>14.95</b>	15.50



**Brown** Cast Acrylic Sheet

CODE	Size mm	Thickness	Unit	4+	1+
ACR640SBR	600 x 400	3mm	1	<b>5.95</b>	6.25
ACR105SBR	1000 x 500	3mm	1	<b>12.50</b>	12.95
ACR106SBR	1000 x 600	3mm	1	<b>14.95</b>	15.50



**Frosted Clear** Special Effect Matt Cast Acrylic Sheet

CODE	Size mm	Thickness	Unit	4+	1+
ACR105MCL	1000 x 500	3mm	1	<b>15.50</b>	15.95



**Cerise Pink** Cast Acrylic Sheet

CODE	Size mm	Thickness	Unit	4+	1+
ACR640SPC	600 x 400	3mm	1	<b>5.95</b>	6.25
ACR564SPC	1000 x 500	5mm	1	<b>11.95</b>	12.50
ACR105SPC	1000 x 500	3mm	1	<b>12.50</b>	12.95
ACR106SPC	1000 x 600	3mm	1	<b>14.95</b>	15.50
ACR515SPC	1000 x 500	5mm	1	<b>23.75</b>	24.50



**Purple** Cast Acrylic Sheet

CODE	Size mm	Thickness	Unit	4+	1+
ACR640SPU	600 x 400	3mm	1	<b>5.95</b>	6.25
ACR105SPU	1000 x 500	3mm	1	<b>12.50</b>	12.95
ACR106SPU	1000 x 600	3mm	1	<b>14.95</b>	15.50



**Matt Black** Special Effect Matt Cast Acrylic Sheet

CODE	Size mm	Thickness	Unit	4+	1+
ACR105MBK	1000 x 500	3mm	1	<b>16.50</b>	16.95



## Clear Cast Acrylic Sheets

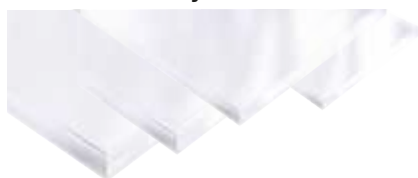

CODE	Size mm	Thickness	Unit	4+	1+
ACR642CLR	600 x 400	2mm	1	<b>4.95</b>	5.15
ACR640CLR	600 x 400	3mm	1	<b>5.75</b>	5.95
ACR645CLR	600 x 400	5mm	1	<b>9.95</b>	10.75
ACR646CLR	600 x 400	6mm	1	<b>11.95</b>	12.75
ACR648CLR	600 x 400	8mm	1	<b>15.95</b>	16.75
ACR641CLR	600 x 400	10mm	1	<b>19.95</b>	20.95
ACR152CLR	1000 x 500	2mm	1	<b>9.25</b>	9.75
ACR105CLR	1000 x 500	3mm	1	<b>11.95</b>	12.75
ACR515CLR	1000 x 500	5mm	1	<b>19.95</b>	20.95
ACR156CLR	1000 x 500	6mm	1	<b>23.75</b>	24.95
ACR158CLR	1000 x 500	8mm	1	<b>32.25</b>	33.95
ACR151CLR	1000 x 500	10mm	1	<b>39.95</b>	42.50
ACR162CLR	1000 x 600	2mm	1	<b>10.95</b>	11.50
ACR106CLR	1000 x 600	3mm	1	<b>14.25</b>	14.95
ACR516CLR	1000 x 600	5mm	1	<b>23.25</b>	24.50
ACR166CLR	1000 x 600	6mm	1	<b>26.95</b>	27.95
ACR168CLR	1000 x 600	8mm	1	<b>36.25</b>	37.25
ACR161CLR	1000 x 600	10mm	1	<b>45.50</b>	46.75

## Clear Cast Acrylic Sheets

Pack of 5 or 10

CODE	Size mm	Thickness	Unit	1+
ACR564CLR	600 x 400	3mm	Pack of 5	<b>28.50</b>
ACR640CST	600 x 400	3mm	Pack of 10	<b>56.95</b>
ACR105CST	1000 x 500	3mm	Pack of 10	<b>117.95</b>
ACR106CST	1000 x 600	3mm	Pack of 10	<b>139.95</b>

## Solid Black Cast Acrylic Sheets

Pack of 10

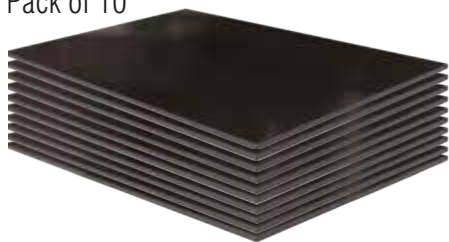

CODE	Size mm	Thickness	Unit	2+	1+
ACR640BKP	600 x 400	3mm	Pk10	<b>55.00</b>	58.95
ACR105BKP	1000 x 500	3mm	Pk10		<b>124.00</b>
ACR106BKP	1000 x 600	3mm	Pk10		<b>149.00</b>

## Solid White Cast Acrylic Sheets

Pack of 10



CODE	Size mm	Thickness	Unit	1+
ACR640WHP	600 x 400	3mm	Pack of 10	<b>58.95</b>
ACR105WHP	1000 x 500	3mm	Pack of 10	<b>124.00</b>
ACR106WHP	1000 x 600	3mm	Pack of 10	<b>149.00</b>

## Clear Extruded Acrylic Sheets

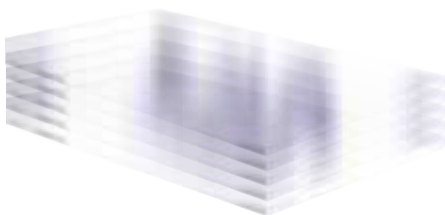

- Clear high quality XT extruded acrylic sheets.
- Consistent thickness, suitable for laser cutters.
- Available in extra thin sheets, down to 1.5mm.

CODE	Size mm	Thickness	Unit	4+	1+
ACR615ECL	600 x 400mm	1.5mm	1	<b>3.35</b>	3.50
ACR618ECL	600 x 400mm	1.8mm	1	<b>3.50</b>	3.75
ACR620ECL	600 x 400mm	2.0mm	1	<b>3.75</b>	3.95
ACR625ECL	600 x 400mm	2.5mm	1	<b>5.25</b>	5.50
ACR630ECL	600 x 400mm	3.0mm	1	<b>5.50</b>	5.75

## Fluorescent Cast Acrylic Sheets



### Neon Blue Fluorescent Cast Acrylic Sheet

CODE	Size mm	Thickness	Unit	4+	1+
ACR640FBU	600 x 400	3mm	1	<b>7.75</b>	7.95
ACR105FBU	1000 x 500	3mm	1	<b>16.25</b>	16.95



### Neon Lime Green Fluorescent Cast Acrylic Sheet

CODE	Size mm	Thickness	Unit	4+	1+
ACR640FGL	600 x 400	3mm	1	<b>7.75</b>	7.95
ACR105FGL	1000 x 500	3mm	1	<b>16.25</b>	16.95



### Neon Yellow Fluorescent Cast Acrylic Sheet

CODE	Size mm	Thickness	Unit	4+	1+
ACR640FYL	600 x 400	3mm	1	<b>7.75</b>	7.95
ACR105FYL	1000 x 500	3mm	1	<b>16.25</b>	16.95



### Neon Red Fluorescent Cast Acrylic Sheet

CODE	Size mm	Thickness	Unit	4+	1+
ACR640FRD	600 x 400	3mm	1	<b>7.75</b>	7.95
ACR105FRD	1000 x 500	3mm	1	<b>16.25</b>	16.95



### Neon Orange Fluorescent Cast Acrylic Sheet

CODE	Size mm	Thickness	Unit	4+	1+
ACR640FOR	600 x 400	3mm	1	<b>7.75</b>	7.95
ACR105FOR	1000 x 500	3mm	1	<b>16.25</b>	16.95

## Tinted Cast Acrylic Sheets



**Blue Tinted Cast Acrylic Sheet**

CODE	Size mm	Thickness	Unit	4+	1+
ACR640TBU	600 x 400	3mm	1	<b>6.50</b>	6.75
ACR105TBU	1000 x 500	3mm	1	<b>12.95</b>	13.50



**Amber Tinted Cast Acrylic Sheet**

CODE	Size mm	Thickness	Unit	4+	1+
ACR640TAM	600 x 400	3mm	1	<b>6.50</b>	6.75
ACR105TAM	1000 x 500	3mm	1	<b>12.95</b>	13.50



**Grey Smoked Tinted Cast Acrylic Sheet**

CODE	Size mm	Thickness	Unit	4+	1+
ACR640TGS	600 x 400	3mm	1	<b>6.50</b>	6.75
ACR105TGS	1000 x 500	3mm	1	<b>12.95</b>	13.50



**Red Tinted Cast Acrylic Sheet**

CODE	Size mm	Thickness	Unit	4+	1+
ACR640TRD	600 x 400	3mm	1	<b>6.50</b>	6.75
ACR105TRD	1000 x 500	3mm	1	<b>12.95</b>	13.50



**Yellow Tinted Cast Acrylic Sheet**

CODE	Size mm	Thickness	Unit	4+	1+
ACR640TYL	600 x 400	3mm	1	<b>6.50</b>	6.75
ACR105TYL	1000 x 500	3mm	1	<b>12.95</b>	13.50



**Green Tinted Cast Acrylic Sheet**

CODE	Size mm	Thickness	Unit	4+	1+
ACR640TGR	600 x 400	3mm	1	<b>6.50</b>	6.75
ACR105TGR	1000 x 500	3mm	1	<b>12.95</b>	13.50



**Bronze Tinted Cast Acrylic Sheet**

CODE	Size mm	Thickness	Unit	4+	1+
ACR640TBR	600 x 400	3mm	1	<b>6.50</b>	6.75
ACR105TBR	1000 x 500	3mm	1	<b>12.95</b>	13.50

## Sparkle Colours Cast Acrylic Sheets

- A unique sparkling look on one surface.
- Available in a silver and gold, plus range of metallic colours - supplied in our standard sized panels.
- Single sided sparkling gloss finish, and the reverse having a metallic silver or black surface.
- Acts as the standard cast product - can be thermoformed, milled, sawn, polished and laser cut.



**Silver Grey Sparkle Cast Acrylic Sheet**

CODE	Size mm	Thickness	Unit	4+	1+
ACR640AGY	600 x 400	3mm	1	<b>10.95</b>	11.50
ACR105AGY	1000 x 500	3mm	1	<b>26.95</b>	28.50



**Gold Sparkle Cast Acrylic Sheet**

CODE	Size mm	Thickness	Unit	4+	1+
ACR640AGO	600 x 400	3mm	1	<b>11.95</b>	11.50
ACR105AGO	1000 x 500	3mm	1	<b>26.95</b>	28.50



**Blue Sparkle Cast Acrylic Sheet**

CODE	Size mm	Thickness	Unit	4+	1+
ACR640ABU	600 x 400	3mm	1	<b>10.95</b>	11.50
ACR105ABU	1000 x 500	3mm	1	<b>26.95</b>	28.50



**Black Sparkle Cast Acrylic Sheet**

CODE	Size mm	Thickness	Unit	4+	1+
ACR640ABK	600 x 400	3mm	1	<b>10.95</b>	11.50
ACR105ABK	1000 x 500	3mm	1	<b>26.95</b>	28.50

## Frosted Colours Cast Acrylic Sheets

- This lustrous satin-like finish won't stain or be contaminated through finger-marks.
- Available in a wide range of eye-catching colours - supplied in our standard sized panels.
- Non-glare surface softens harsh colours and diffuses light.
- Frosted look is retained even after thermoforming or bending.



Violet Frosted Cast Acrylic Sheet

CODE	Size mm	Thickness	Unit	4+	1+
ACR640DVL	600 x 400	3mm	1	<b>9.50</b>	9.95
ACR105DVL	1000 x 500	3mm	1	<b>18.95</b>	19.95



Red Frosted Cast Acrylic Sheet

CODE	Size mm	Thickness	Unit	4+	1+
ACR640DRD	600 x 400	3mm	1	<b>9.50</b>	9.95
ACR105DRD	1000 x 500	3mm	1	<b>18.95</b>	19.95



Orange Frosted Cast Acrylic Sheet

CODE	Size mm	Thickness	Unit	4+	1+
ACR640DOR	600 x 400	3mm	1	<b>9.50</b>	9.95
ACR105DOR	1000 x 500	3mm	1	<b>18.95</b>	19.95



Pink Frosted Cast Acrylic Sheet

CODE	Size mm	Thickness	Unit	4+	1+
ACR640DPK	600 x 400	3mm	1	<b>9.50</b>	9.95
ACR105DPK	1000 x 500	3mm	1	<b>18.95</b>	19.95



Aqua Frosted Cast Acrylic Sheet

CODE	Size mm	Thickness	Unit	4+	1+
ACR640DAQ	600 x 400	3mm	1	<b>9.50</b>	9.95
ACR105DAQ	1000 x 500	3mm	1	<b>18.95</b>	19.95

## Mirrored Acrylic Sheets

- A new edition to our extensive range of acrylic sheets.
- This coloured mirror sheet adds vibrancy and another dimension to any acrylic project.
- Usually too highly priced for use in schools, however, we have made a bulk purchase and enabled the savings to be passed on to you!
- Single sided and highly reflective.



Blue Mirror Acrylic Sheet

CODE	Size mm	Thickness	Unit	4+	1+
ACR640MBU	600 x 400	3mm	1	<b>14.95</b>	15.95



Green Mirror Acrylic Sheet

CODE	Size mm	Thickness	Unit	4+	1+
ACR640MGR	600 x 400	3mm	1	<b>14.95</b>	15.95



Red Mirror Acrylic Sheet

CODE	Size mm	Thickness	Unit	4+	1+
ACR640MRD	600 x 400	3mm	1	<b>14.95</b>	15.95



Pink Mirror Acrylic Sheet

CODE	Size mm	Thickness	Unit	4+	1+
ACR640MPK	600 x 400	3mm	1	<b>14.95</b>	15.95



Violet Mirror Acrylic Sheet

CODE	Size mm	Thickness	Unit	4+	1+
ACR640MVT	600 x 400	3mm	1	<b>14.95</b>	15.95



Gold Mirror Acrylic Sheet

CODE	Size mm	Thickness	Unit	4+	1+
ACR640MGL	585 x 395	3mm	1	<b>10.50</b>	10.95



Copper Mirror Acrylic Sheet

CODE	Size mm	Thickness	Unit	4+	1+
ACR640MCP	600 x 400	3mm	1	<b>14.95</b>	15.95



Rose Gold Mirror Acrylic Sheet

CODE	Size mm	Thickness	Unit	4+	1+
ACR640MRG	585 x 395	3mm	1	<b>10.50</b>	10.95



Silver Mirror Acrylic Sheet

CODE	Size mm	Thickness	Unit	4+	1+
ACR640MRR	585 x 395	3mm	1	<b>28.95</b>	29.95
ACR126MRR	1200 x 600	3mm	1	<b>9.95</b>	10.50

Cast Acrylic Sheets

## Pastels Cast Acrylic Sheets

- Attractive range of eight sweet pastels.
- Versatile, as one side is satin and the other is gloss.



**Candy Floss Blue Pastel Cast Acrylic Sheet**

CODE	Size mm	Thickness	Unit	4+	1+
ACR640CFB	600 x 400	3mm	1	8.50	8.75

**Sour Grape Pastel Cast Acrylic Sheet**

CODE	Size mm	Thickness	Unit	4+	1+
ACR640GPE	600 x 400	3mm	1	8.50	8.75



**Raspberry Sherbet Pastel Cast Acrylic Sheet**

CODE	Size mm	Thickness	Unit	4+	1+
ACR640RSH	600 x 400	3mm	1	8.50	8.75



**Orange Fizz Pastel Cast Acrylic Sheet**

CODE	Size mm	Thickness	Unit	4+	1+
ACR640OFZ	600 x 400	3mm	1	8.50	8.75

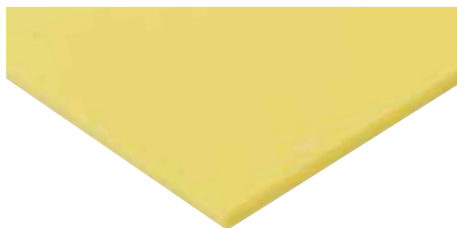

**Lemon Bonbon Pastel Cast Acrylic Sheet**

CODE	Size mm	Thickness	Unit	4+	1+
ACR640LBB	600 x 400	3mm	1	8.50	8.75

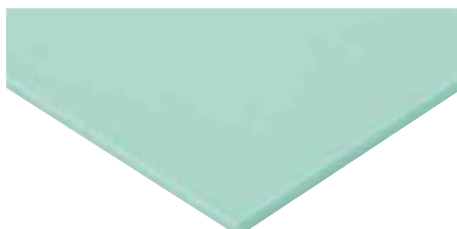

**Spearmint Green Pastel Cast Acrylic Sheet**

CODE	Size mm	Thickness	Unit	4+	1+
ACR640SGN	600 x 400	3mm	1	8.50	8.75

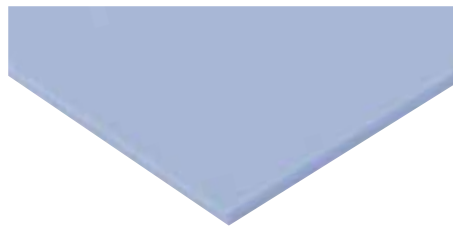

**Candy Floss Blue Pastel Cast Acrylic Sheet**

CODE	Size mm	Thickness	Unit	4+	1+
ACR640CFB	600 x 400	3mm	1	8.50	8.75



**Bubbligum Pastel Cast Acrylic Sheet**

CODE	Size mm	Thickness	Unit	4+	1+
ACR640BGM	600 x 400	3mm	1	8.50	8.75



**Parma Violet Pastel Cast Acrylic Sheet**

CODE	Size mm	Thickness	Unit	4+	1+
ACR640PVT	600 x 400	3mm	1	8.50	8.75

## Highlights Cast Acrylic Sheets



CODE	Colour	Unit	4+	1+
ACR640HFY	Fiesta Yellow	1	7.95	8.50
ACR640HCO	Carnival Orange	1	7.95	8.50
ACR640HFP	Flamenco Pink	1	7.95	8.50
ACR640HLG	Luau Green	1	7.95	8.50

## Pearlescent Cast Acrylic Sheets

- The pearlescent effect is created by the orientation of metallic flakes.
- Reflective finish on one side only.

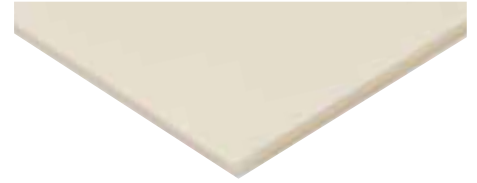

**Pear Pearlescent Cast Acrylic Sheet**

CODE	Size mm	Thickness	Unit	4+	1+
ACR640PPL	600 x 400	3mm	1	10.50	10.95



**Candy Pearlescent Cast Acrylic Sheet**

CODE	Size mm	Thickness	Unit	4+	1+
ACR640PCY	600 x 400	3mm	1	10.50	10.95

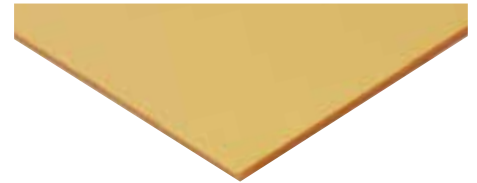

**Caramel Gold Pearlescent Cast Acrylic Sheet**

CODE	Size mm	Thickness	Unit	4+	1+
ACR640PCG	600 x 400	3mm	1	10.50	10.95

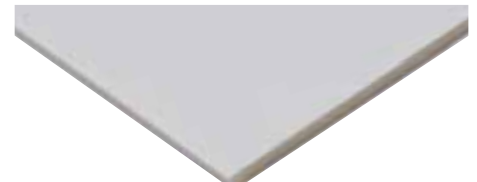

**Platinum Pearlescent Cast Acrylic Sheet**

CODE	Size mm	Thickness	Unit	4+	1+
ACR640PPT	600 x 400	3mm	1	10.50	10.95

## Glass Look Cast Acrylic Sheets

- Provides the appearance of glass with a green tint edge, but with half the weight and five times the impact strength.
- Offers the aesthetics but without the associated risk of breakages.

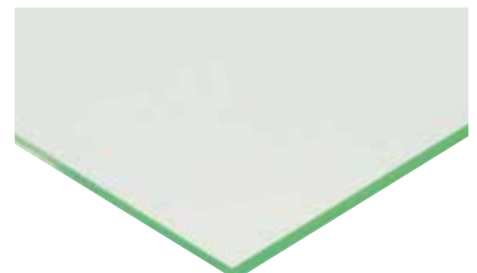

CODE	Size mm	Thickness	Unit	4+	1+
ACR640GLL	600 x 400	3mm	1	7.25	7.50

## Solid Colours Assorted Packs Cast Acrylic Sheets

Pack of 8



- Yellow, Classic Red, Orange, Cerise Pink, Lime Green, Dark Blue, White and Black.

CODE	Size mm	Thickness	Unit	2+	1+
ACR864SST	600 x 400	3mm	Pk8	<b>46.95</b>	48.95
ACR815SET	1000 x 500	3mm	Pk8	<b>97.50</b>	99.50
ACR564SST	600 x 400	5mm	Pk8	<b>92.95</b>	95.95
ACR510SST	1000 x 500	5mm	Pk8	<b>179.50</b>	189.50

## Solid Colours Assorted Packs Cast Acrylic Sheets

Pack of 12



- Lime Green, Dark Blue, Cerise Pink, Light Pink, Classic Red, Yellow, Brown, Orange, Dark Green, Flame Red, White and Black.

CODE	Size mm	Thickness	Unit	2+	1+
ACR600SST	600 x 400	3mm	Pk12	<b>69.50</b>	72.50
ACR100SST	1000 x 500	3mm	Pk12	<b>147.50</b>	152.50
ACR106SST	1000 x 600	3mm	Pk12	<b>177.50</b>	182.50

## Transparent Colours Cast Acrylic Sheets

Pack of 6



- Red, Amber, Bronze, Green, Blue and Yellow.
- Tinted effect.

CODE	Size mm	Thickness	Unit	2+	1+
ACR600TST	600 x 400	3mm	Pk6	<b>37.95</b>	39.95
ACR100TST	1000 x 500	3mm	Pk6	<b>75.95</b>	77.95

## Frosted Colours Cast Acrylic Sheets

Pack of 5

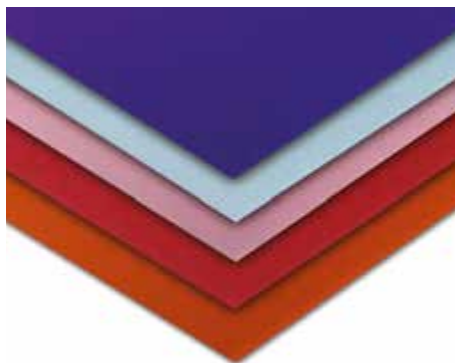

- Violet, Red, Orange, Pink and Aqua

CODE	Size mm	Thickness	Unit	2+	1+
ACR600DST	600 x 400	3mm	Pk5	<b>44.25</b>	45.95
ACR100DST	1000 x 500	3mm	Pk5	<b>84.50</b>	89.50

## Fluorescent Colours Cast Acrylic Sheets

Pack of 5

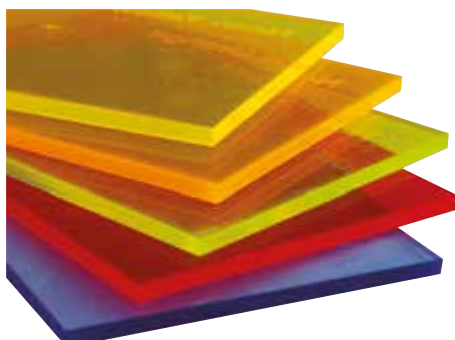

- Neon Yellow, Neon Orange, Neon Green, Neon Red and Neon Blue

CODE	Size mm	Thickness	Unit	2+	1+
ACR600FST	600 x 400	3mm	Pk5	<b>36.95</b>	38.95
ACR100FST	1000 x 500	3mm	Pk5	<b>79.95</b>	81.95

## Sparkle Colours Cast Acrylic Sheets

Pack of 4

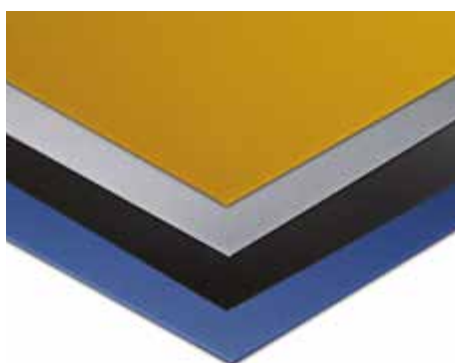

- Grey, Gold, Blue and Black.

CODE	Size mm	Thickness	Unit	2+	1+
ACR600AST	600 x 400	3mm	Pk4	<b>41.95</b>	43.95
ACR100AST	1000 x 500	3mm	Pk4	<b>105.00</b>	107.95

## Solid Colour Acrylic Rod



### Blue Colour Acrylic Rod

CODE	Dia x Length	Colour	Unit	10+	1+
ARD604SBU	4.8 x 610mm	Blue	1	<b>2.95</b>	3.30
ARD606SBU	6.4 x 610mm	Blue	1	<b>4.40</b>	4.95



### Red Acrylic Rod

CODE	Dia x Length	Colour	Unit	10+	1+
ARD604SRD	4.8 x 610mm	Red	1	<b>2.95</b>	3.30
ARD606SRD	6.4 x 610mm	Red	1	<b>4.40</b>	4.95



### Green Acrylic Rod

CODE	Dia x Length	Colour	Unit	10+	1+
ARD604SGR	4.8 x 610mm	Green	1	<b>2.95</b>	3.30
ARD606SGR	6.4 x 610mm	Green	1	<b>4.40</b>	4.95



### Orange Acrylic Rod

CODE	Dia x Length	Colour	Unit	10+	1+
ARD604SOR	4.8 x 610mm	Orange	1	<b>2.95</b>	3.30
ARD606SOR	6.4 x 610mm	Orange	1	<b>4.40</b>	4.95



### Yellow Acrylic Rod

CODE	Dia x Length	Colour	Unit	10+	1+
ARD604SYL	4.8 x 610mm	Yellow	1	<b>2.95</b>	3.30
ARD606SYL	6.4 x 610mm	Yellow	1	<b>4.40</b>	4.95



### Black Acrylic Rod

CODE	Dia x Length	Colour	Unit	10+	1+
ARD604SBK	4.8 x 610mm	Black	1	<b>2.95</b>	3.30
ARD606SBK	6.4 x 610mm	Black	1	<b>4.40</b>	4.95



### White Acrylic Rod

CODE	Dia x Length	Colour	Unit	10+	1+
ARD604SWH	4.8 x 610mm	White	1	<b>2.95</b>	3.30
ARD606SWH	6.4 x 610mm	White	1	<b>4.40</b>	4.95

## Metallic Acrylic Rod



### Metallic Gold Acrylic Rod

CODE	Dia x Length	Colour	Unit	10+	1+
ARD606SMG	4.8 x 610mm	Metallic Gold	1	4.40	4.95



### Metallic Silver Acrylic Rod

CODE	Dia x Length	Colour	Unit	10+	1+
ARD606SMS	4.8 x 610mm	Metallic Silver	1	4.40	4.95

## Transparent Acrylic Rod



### Blue Transparent Acrylic Rod

CODE	Dia x Length	Colour	Unit	10+	1+
ARD604TBU	4.8 x 610mm	Blue	1	2.95	3.30
ARD606TBU	6.4 x 610mm	Blue	1	4.40	4.95



### Red Transparent Acrylic Rod

CODE	Dia x Length	Colour	Unit	10+	1+
ARD604TRD	4.8 x 610mm	Red	1	2.95	3.30
ARD606TRD	6.4 x 610mm	Red	1	4.40	4.95



### Green Transparent Acrylic Rod

CODE	Dia x Length	Colour	Unit	10+	1+
ARD604TGR	4.8 x 610mm	Green	1	2.95	3.30
ARD606TGR	6.4 x 610mm	Green	1	4.40	4.95



### Yellow Transparent Acrylic Rod

CODE	Dia x Length	Colour	Unit	10+	1+
ARD604TYL	4.8 x 610mm	Yellow	1	2.95	3.30
ARD606TYL	6.4 x 610mm	Yellow	1	4.40	4.95

## Fluorescent Acrylic Rod



### Blue Fluorescent Acrylic Rod

CODE	Dia x Length	Colour	Unit	10+	1+
ARD504FBL	4 x 500mm	Blue	1	1.25	1.40
ARD506FBL	6 x 500mm	Blue	1	2.10	2.40
ARD510FBL	10 x 500mm	Blue	1	5.25	5.75



### Green Fluorescent Acrylic Rod

CODE	Dia x Length	Colour	Unit	10+	1+
ARD504FGL	4 x 500mm	Green	1	1.25	1.40
ARD506FGL	6 x 500mm	Green	1	2.10	2.40
ARD510FGL	10 x 500mm	Green	1	5.25	5.75



### Red Fluorescent Acrylic Rod

CODE	Dia x Length	Colour	Unit	10+	1+
ARD504FRD	4 x 500mm	Red	1	1.25	1.40
ARD506FRD	6 x 500mm	Red	1	2.10	2.40
ARD510FRD	10 x 500mm	Red	1	5.25	5.75



### Yellow Fluorescent Acrylic Rod

CODE	Dia x Length	Colour	Unit	10+	1+
ARD504FYL	4 x 500mm	Yellow	1	1.25	1.40
ARD506FYL	6 x 500mm	Yellow	1	2.10	2.40
ARD510FYL	10 x 500mm	Yellow	1	5.25	5.75

## Fluorescent Acrylic Rods Bulk Pack of 20



- Assorted pack of 20 Fluorescent Rods in three sizes and four colours.
- Consists of 2 x 4mm, 2 x 6mm and 1 x 10mm.
- Colours - blue, green, red and yellow.

### 500mm Length

CODE	Description	Unit	1+
ARD205FLU	Acrylic Rod Coloured	Bulk Pack	39.95

## Transparent Acrylic Tube



### Blue Transparent Acrylic Tube

CODE	Dia x Length	Colour	Unit	10+	1+
ATB606TBU	6.4/3.2 x 610mm	Blue	1	2.95	3.40
ATB609TBU	9.5/6.4 x 610mm	Blue	1	5.25	5.95
ATB612TBU	12.7/9.5 x 610mm	Blue	1	7.50	8.50



### Green Transparent Acrylic Tube

CODE	Dia x Length	Colour	Unit	10+	1+
ATB606TGR	6.4/3.2 x 610mm	Green	1	2.95	3.40
ATB609TGR	9.5/6.4 x 610mm	Green	1	5.25	5.95
ATB612TGR	12.7/9.5 x 610mm	Green	1	7.50	8.50



### Red Transparent Acrylic Tube

CODE	Dia x Length	Colour	Unit	10+	1+
ATB606TRD	6.4/3.2 x 610mm	Red	1	2.95	3.40
ATB609TRD	9.5/6.4 x 610mm	Red	1	5.25	5.95
ATB612TRD	12.7/9.5 x 610mm	Red	1	7.50	8.50



### Yellow Transparent Acrylic Tube

CODE	Dia x Length	Colour	Unit	10+	1+
ATB606TYL	6.4/3.2 x 610mm	Yellow	1	2.95	3.40
ATB609TYL	9.5/6.4 x 610mm	Yellow	1	5.25	5.95
ATB612TYL	12.7/9.5 x 610mm	Yellow	1	7.50	8.50

## Coloured Acrylic Tubes Bulk Pack of 12



- Assorted pack of 12 Transparent tubes in three sizes and four colours.
- Consists of 1 x 6.4/3.2mm, 1 x 9.5/6.4mm and 1 x 12.7/9.5mm.
- Colours - blue, green, red and yellow.

### 610mm Length

CODE	Description	Unit	1+
ATB126TRA	Acrylic Tube Coloured	Bulk Pack	49.95

## Clear Acrylic Rod



### 500mm Length

CODE	Diameter	Colour	Unit	10+	1+
ARD503CLR	3mm	Clear	1	<b>0.40</b>	0.45
ARD504CLR	4mm	Clear	1	<b>0.65</b>	0.70
ARD505CLR	5mm	Clear	1	<b>0.75</b>	0.85
ARD506CLR	6mm	Clear	1	<b>1.05</b>	1.20
ARD508CLR	8mm	Clear	1	<b>1.65</b>	1.85
ARD510CLR	10mm	Clear	1	<b>1.95</b>	2.20
ARD512CLR	12mm	Clear	1	<b>2.80</b>	3.10
ARD515CLR	15mm	Clear	1	<b>4.40</b>	4.90
ARD520CLR	20mm	Clear	1	<b>7.75</b>	8.75

## Clear Bubble Acrylic Rod



### 500mm Length

CODE	Diameter	Colour	Unit	10+	1+
ARD505CBB	5mm	Clear	1	<b>0.95</b>	1.10
ARD510CBB	10mm	Clear	1	<b>3.50</b>	3.95
ARD515CBB	15mm	Clear	1	<b>6.25</b>	6.95
ARD520CBB	20mm	Clear	1	<b>11.25</b>	12.50

## Clear Acrylic Tube



### 500mm Length

CODE	Diameter	Colour	Unit	10+	1+
ATB506CLR	6/4mm	Clear	1	<b>1.30</b>	1.45
ATB510CLR	10/8mm	Clear	1	<b>1.10</b>	1.25
ATB512CLR	12/8mm	Clear	1	<b>1.60</b>	1.80
ATB515CLR	15/11mm	Clear	1	<b>2.10</b>	2.30
ATB520CLR	20/16mm	Clear	1	<b>2.50</b>	2.80
ATB525CLR	25/21mm	Clear	1	<b>2.95</b>	3.30
ATB530CLR	30/26mm	Clear	1	<b>3.40</b>	3.80
ATB540CLR	40/36mm	Clear	1	<b>4.70</b>	5.25
ATB550CLR	50/46mm	Clear	1	<b>6.50</b>	7.25
ATB560CLR	60/56mm	Clear	1	<b>9.50</b>	10.75
ATB570CLR	70/66mm	Clear	1	<b>10.50</b>	11.75

## Clear Acrylic Rods

Pack of 25



- Consists of 4 x 3mm, 4 x 4mm, 4 x 5mm, 4 x 6mm, 4 x 8mm, 2 x 10mm, 1 x 12mm, 1 x 15mm and 1 x 20mm.

### 500mm Length

CODE	Description	Unit	1+
ARD255CLR	Acrylic Rod Clear	Pack of 25	<b>29.95</b>

## Clear Bubble Acrylic Rods

Pack of 10



- Consists of 4 x 5mm, 4 x 10mm and 2 x 15mm.

### 500mm Length

CODE	Description	Unit	1+
ARD105CBB	Acrylic Rod Clear	Pack of 10	<b>27.95</b>

## Clear Acrylic Tubes

Pack of 20



- Consists of 4 x 6/4mm, 4 x 10mm, 4 x 12/8mm, 2 x 15/11mm, 2 x 20/16mm, 2 x 25/21mm, 1 x 30/26mm and 1 x 40/36mm.

### 500mm Length

CODE	Description	Unit	1+
ATB205CLR	Acrylic Tube Clear	Pack of 20	<b>35.00</b>

## Clear Acrylic Square Bar



### 610mm Length

CODE	Size	Colour	Unit	10+	1+
ASB603CLR	3mm	Clear	1	<b>1.35</b>	1.50
ASB604CLR	4mm	Clear	1	<b>1.75</b>	1.95
ASB605CLR	5mm	Clear	1	<b>1.90</b>	2.10
ASB606CLR	6mm	Clear	1	<b>2.20</b>	2.50
ASB608CLR	8mm	Clear	1	<b>3.50</b>	3.95
ASB610CLR	10mm	Clear	1	<b>3.80</b>	4.30

## Clear Acrylic Candy Twist



- Decorative clear rod design.

### 500mm Length

CODE	Diameter	Colour	Unit	10+	1+
ACT509CLR	9.5mm	Clear	1	<b>2.60</b>	2.90
ACT512CLR	12.7mm	Clear	1	<b>4.90</b>	5.50

## Clear Acrylic Square Tube



### 610mm Length

CODE	Size	Colour	Unit	10+	1+
AST609CLR	9.5/6.4mm	Clear	1	<b>4.10</b>	4.60
AST612CLR	12.5/9.5mm	Clear	1	<b>5.50</b>	6.25
AST616CLR	16/12.5mm	Clear	1	<b>7.75</b>	8.75
AST619CLR	19/16mm	Clear	1	<b>9.25</b>	10.25

Acrylic Fixtures

## Clear Acrylic Triangle Fillet



- Used to strengthen butt joints.

610mm Length

CODE	Size	Colour	Unit	10+	1+
ATF603CLR	3mm	Clear	1	<b>0.85</b>	0.95
ATF604CLR	4mm	Clear	1	<b>1.20</b>	1.35
ATF605CLR	5mm	Clear	1	<b>1.35</b>	1.50

## Clear Acrylic Balls

Pack of 10 or 5



CODE	Size	Unit	5+	1+
ABL810CLR	8mm	Pack of 10	<b>5.50</b>	6.25
ABL101CLR	10mm	Pack of 10	<b>6.95</b>	7.95
ABL121CLR	12mm	Pack of 10	<b>8.75</b>	9.75
ABL181CLR	18mm	Pack of 10	<b>13.95</b>	15.50
ABL201CLR	20mm	Pack of 10	<b>14.25</b>	15.95
ABL255CLR	25mm	Pack of 5	<b>10.75</b>	11.95

## Clear Acrylic Suction Caps

Pack of 10



CODE	Size	Unit	5+	1+
AFA020SCP	20mm dia	Pack of 10	<b>3.50</b>	3.90

## Clear Acrylic Mini Hinges

Pack of 10



CODE	Size	Unit	5+	1+
AFA332HGM	33 x 25mm	Pack of 10	<b>9.95</b>	11.25

## Clear Acrylic Keyhole Plate

Pack of 10



CODE	Size	Unit	5+	1+
AFA292KHP	29 x 25mm	Pack of 10	<b>3.20</b>	3.60

## Clear Acrylic Hasp and Staple



CODE	Size	Unit	5+	1+
AFA806HAS	80/60 x 26mm	1	<b>2.60</b>	2.95

## Clear Acrylic Standard Hinges

Pack of 10



CODE	Size	Unit	5+	1+
AFA454HGS	45 x 39mm	Pack of 10	<b>7.50</b>	8.50

## Clear Acrylic Door Catches

Pack of 10



CODE	Size	Unit	5+	1+
AFA202DCT	29 x 25mm	Pack of 10	<b>12.25</b>	13.75

## Clear Plastic Nuts and Bolts

Pack of 50



CODE	Size	Unit	5+	1+
AFA412NBT	M4 x 12	Pack of 50	<b>26.50</b>	29.50
AFA416NBT	M4 x 16	Pack of 50	<b>27.25</b>	30.50

## Clear Acrylic Piano Hinge



CODE	Size	Unit	5+	1+
AFA345HGP	300 x 45mm	1	<b>3.80</b>	4.20

## Clear Acrylic Magnetic Catches

Pack of 10

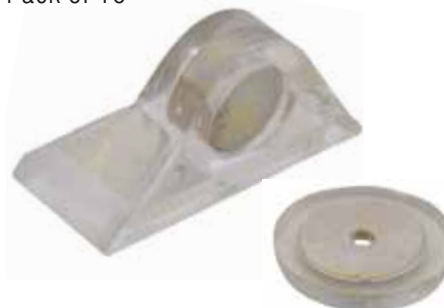

CODE	Size	Unit	5+	1+
AFA210MCT	21 x 10 x 10mm	Pack of 10	<b>29.95</b>	33.50

## Acrylic Bearing Turntable



- Ideal for rotating displays.
- Acrylic lazy susan with ball bearings.
- Available in two diameters.

CODE	Size	Unit	1+
ABT140TTB	140mm	1	<b>8.95</b>



## High Impact Polystyrene (HIPS)



### Black High Impact Polystyrene (HIPS) Vacuum Forming Sheets

CODE	Colour	Sheet Size	Thickness	Unit	20+	10+	1+
HIP210GBK	Black	254 x 457mm	1mm	1	<b>1.05</b>	1.20	1.30
HIP215GBK	Black	254 x 457mm	1.5mm	1	<b>1.50</b>	1.70	1.80
HIP220GBK	Black	254 x 457mm	2mm	1	<b>2.05</b>	2.20	2.40
HIP310GBK	Black	305 x 457mm	1mm	1	<b>1.15</b>	1.30	1.50
HIP315GBK	Black	305 x 457mm	1.5mm	1	<b>1.50</b>	1.70	1.80
HIP320GBK	Black	305 x 457mm	2mm	1	<b>2.00</b>	2.10	2.30
HIP510GBK	Black	508 x 457mm	1mm	1	<b>2.35</b>	2.50	2.80
HIP515GBK	Black	508 x 457mm	1.5mm	1	<b>3.05</b>	3.30	3.70
HIP520GBK	Black	508 x 457mm	2mm	1	<b>3.95</b>	4.40	4.80
HIP610GBK	Black	610 x 457mm	1mm	1	<b>2.40</b>	2.60	2.80
HIP615GBK	Black	610 x 457mm	1.5mm	1	<b>3.05</b>	3.30	3.70
HIP620GBK	Black	610 x 457mm	2mm	1	<b>3.85</b>	4.30	4.70



### White High Impact Polystyrene (HIPS) Vacuum Forming Sheets

CODE	Colour	Sheet Size	Thickness	Unit	20+	10+	1+
HIP210GWH	White	254 x 457mm	1mm	1	<b>0.95</b>	1.00	1.10
HIP215GWH	White	254 x 457mm	1.5mm	1	<b>1.50</b>	1.70	1.80
HIP220GWH	White	254 x 457mm	2mm	1	<b>2.05</b>	2.20	2.40
HIP310GWH	White	305 x 457mm	1mm	1	<b>1.00</b>	1.10	1.20
HIP315GWH	White	305 x 457mm	1.5mm	1	<b>1.50</b>	1.70	1.80
HIP320GWH	White	305 x 457mm	2mm	1	<b>2.00</b>	2.10	2.30
HIP510GWH	White	508 x 457mm	1mm	1	<b>1.85</b>	2.10	2.30
HIP515GWH	White	508 x 457mm	1.5mm	1	<b>3.05</b>	3.30	3.70
HIP520GWH	White	508 x 457mm	2mm	1	<b>3.95</b>	4.40	4.80
HIP610GWH	White	610 x 457mm	1mm	1	<b>2.05</b>	2.20	2.40
HIP615GWH	White	610 x 457mm	1.5mm	1	<b>3.05</b>	3.30	3.70
HIP620GWH	White	610 x 457mm	2mm	1	<b>3.85</b>	4.30	4.70



### Red High Impact Polystyrene (HIPS) Vacuum Forming Sheets

CODE	Colour	Sheet Size	Thickness	Unit	20+	10+	1+
HIP210GRD	Red	254 x 457mm	1mm	1	<b>1.10</b>	1.20	1.40
HIP215GRD	Red	254 x 457mm	1.5mm	1	<b>1.60</b>	1.80	2.00
HIP220GRD	Red	254 x 457mm	2mm	1	<b>2.20</b>	2.50	2.70
HIP310GRD	Red	305 x 457mm	1mm	1	<b>1.25</b>	1.40	1.50
HIP315GRD	Red	305 x 457mm	1.5mm	1	<b>1.65</b>	1.80	2.00
HIP320GRD	Red	305 x 457mm	2mm	1	<b>2.30</b>	2.50	2.60
HIP510GRD	Red	508 x 457mm	1mm	1	<b>2.15</b>	2.30	2.50
HIP515GRD	Red	508 x 457mm	1.5mm	1	<b>3.30</b>	3.60	3.90
HIP520GRD	Red	508 x 457mm	2mm	1	<b>4.55</b>	4.90	5.30
HIP610GRD	Red	610 x 457mm	1mm	1	<b>2.40</b>	2.60	2.80
HIP615GRD	Red	610 x 457mm	1.5mm	1	<b>3.40</b>	3.70	4.00
HIP620GRD	Red	610 x 457mm	2mm	1	<b>4.55</b>	4.90	5.30

- High quality, food grade, high impact material suitable for printing, vacuum forming and fabrication.
- Available in popular dimensions with various quantity rates for bulk purchasing.



### Mid Blue High Impact Polystyrene (HIPS) Vacuum Forming Sheets

CODE	Colour	Sheet Size	Thickness	Unit	20+	10+	1+
HIP210GBU	Mid Blue	254 x 457mm	1mm	1	<b>1.10</b>	1.20	1.40
HIP215GBU	Mid Blue	254 x 457mm	1.5mm	1	<b>1.60</b>	1.80	2.00
HIP220GBU	Mid Blue	254 x 457mm	2mm	1	<b>2.20</b>	2.50	2.70
HIP310GBU	Mid Blue	305 x 457mm	1mm	1	<b>1.25</b>	1.40	1.50
HIP315GBU	Mid Blue	305 x 457mm	1.5mm	1	<b>1.65</b>	1.80	2.00
HIP320GBU	Mid Blue	305 x 457mm	2mm	1	<b>2.30</b>	2.50	2.60
HIP510GBU	Mid Blue	508 x 457mm	1mm	1	<b>2.15</b>	2.30	2.50
HIP515GBU	Mid Blue	508 x 457mm	1.5mm	1	<b>3.30</b>	3.60	3.90
HIP520GBU	Mid Blue	508 x 457mm	2mm	1	<b>4.55</b>	4.90	5.30
HIP610GBU	Mid Blue	610 x 457mm	1mm	1	<b>2.40</b>	2.60	2.80
HIP615GBU	Mid Blue	610 x 457mm	1.5mm	1	<b>3.40</b>	3.70	4.00
HIP620GBU	Mid Blue	610 x 457mm	2mm	1	<b>4.55</b>	4.90	5.30



### Green High Impact Polystyrene (HIPS) Vacuum Forming Sheets

CODE	Colour	Sheet Size	Thickness	Unit	20+	10+	1+
HIP210GGR	Green	254 x 457mm	1mm	1	<b>1.10</b>	1.20	1.40
HIP215GGR	Green	254 x 457mm	1.5mm	1	<b>1.60</b>	1.80	2.00
HIP220GGR	Green	254 x 457mm	2mm	1	<b>2.20</b>	2.50	2.70
HIP310GGR	Green	305 x 457mm	1mm	1	<b>1.25</b>	1.40	1.50
HIP315GGR	Green	305 x 457mm	1.5mm	1	<b>1.65</b>	1.80	2.00
HIP320GGR	Green	305 x 457mm	2mm	1	<b>2.30</b>	2.50	2.60
HIP510GGR	Green	508 x 457mm	1mm	1	<b>2.15</b>	2.30	2.50
HIP515GGR	Green	508 x 457mm	1.5mm	1	<b>3.30</b>	3.60	3.90
HIP520GGR	Green	508 x 457mm	2mm	1	<b>4.55</b>	4.90	5.30
HIP610GGR	Green	610 x 457mm	1mm	1	<b>2.40</b>	2.60	2.80
HIP615GGR	Green	610 x 457mm	1.5mm	1	<b>3.40</b>	3.70	4.00
HIP620GGR	Green	610 x 457mm	2mm	1	<b>4.55</b>	4.90	5.30



### Yellow High Impact Polystyrene (HIPS) Vacuum Forming Sheets

CODE	Colour	Sheet Size	Thickness	Unit	20+	10+	1+
HIP210GYL	Yellow	254 x 457mm	1mm	1	<b>1.10</b>	1.20	1.40
HIP215GYL	Yellow	254 x 457mm	1.5mm	1	<b>1.60</b>	1.80	2.00
HIP220GYL	Yellow	254 x 457mm	2mm	1	<b>2.20</b>	2.50	2.70
HIP310GYL	Yellow	305 x 457mm	1mm	1	<b>1.25</b>	1.40	1.50
HIP315GYL	Yellow	305 x 457mm	1.5mm	1	<b>1.65</b>	1.80	2.00
HIP320GYL	Yellow	305 x 457mm	2mm	1	<b>2.30</b>	2.50	2.60
HIP510GYL	Yellow	508 x 457mm	1mm	1	<b>2.15</b>	2.30	2.50
HIP515GYL	Yellow	508 x 457mm	1.5mm	1	<b>3.30</b>	3.60	3.90
HIP520GYL	Yellow	508 x 457mm	2mm	1	<b>4.55</b>	4.90	5.30
HIP610GYL	Yellow	610 x 457mm	1mm	1	<b>2.40</b>	2.60	2.80
HIP615GYL	Yellow	610 x 457mm	1.5mm	1	<b>3.40</b>	3.70	4.00
HIP620GYL	Yellow	610 x 457mm	2mm	1	<b>4.55</b>	4.90	5.30



### Silver Grey High Impact Polystyrene (HIPS) Vacuum Forming Sheets

CODE	Colour	Sheet Size	Thickness	Unit	20+	10+	1+
HIP210GSV	Silver Grey	254 x 457mm	1mm	1	<b>1.10</b>	1.20	1.40
HIP215GSV	Silver Grey	254 x 457mm	1.5mm	1	<b>1.60</b>	1.80	2.00
HIP220GSV	Silver Grey	254 x 457mm	2mm	1	<b>2.20</b>	2.50	2.70
HIP310GSV	Silver Grey	305 x 457mm	1mm	1	<b>1.25</b>	1.40	1.50
HIP315GSV	Silver Grey	305 x 457mm	1.5mm	1	<b>1.65</b>	1.80	2.00
HIP320GSV	Silver Grey	305 x 457mm	2mm	1	<b>2.30</b>	2.50	2.60
HIP510GSV	Silver Grey	508 x 457mm	1mm	1	<b>2.15</b>	2.30	2.50
HIP515GSV	Silver Grey	508 x 457mm	1.5mm	1	<b>3.30</b>	3.60	3.90
HIP520GSV	Silver Grey	508 x 457mm	2mm	1	<b>4.55</b>	4.90	5.30
HIP610GSV	Silver Grey	610 x 457mm	1mm	1	<b>2.40</b>	2.60	2.80
HIP615GSV	Silver Grey	610 x 457mm	1.5mm	1	<b>3.40</b>	3.70	4.00
HIP620GSV	Silver Grey	610 x 457mm	2mm	1	<b>4.55</b>	4.90	5.30



### Orange High Impact Polystyrene (HIPS) Vacuum Forming Sheets

CODE	Colour	Sheet Size	Thickness	Unit	20+	10+	1+
HIP210GOR	Orange	254 x 457mm	1mm	1	<b>1.10</b>	1.20	1.40
HIP215GOR	Orange	254 x 457mm	1.5mm	1	<b>1.60</b>	1.80	2.00
HIP220GOR	Orange	254 x 457mm	2mm	1	<b>2.20</b>	2.50	2.70
HIP310GOR	Orange	305 x 457mm	1mm	1	<b>1.25</b>	1.40	1.50
HIP315GOR	Orange	305 x 457mm	1.5mm	1	<b>1.65</b>	1.80	2.00
HIP320GOR	Orange	305 x 457mm	2mm	1	<b>2.30</b>	2.50	2.60
HIP510GOR	Orange	508 x 457mm	1mm	1	<b>2.15</b>	2.30	2.50
HIP515GOR	Orange	508 x 457mm	1.5mm	1	<b>3.30</b>	3.60	3.90
HIP520GOR	Orange	508 x 457mm	2mm	1	<b>4.55</b>	4.90	5.30
HIP610GOR	Orange	610 x 457mm	1mm	1	<b>2.40</b>	2.60	2.80
HIP615GOR	Orange	610 x 457mm	1.5mm	1	<b>3.40</b>	3.70	4.00
HIP620GOR	Orange	610 x 457mm	2mm	1	<b>4.55</b>	4.90	5.30



### Purple High Impact Polystyrene (HIPS) Vacuum Forming Sheets

CODE	Colour	Sheet Size	Thickness	Unit	20+	10+	1+
HIP210GPU	Purple	254 x 457mm	1mm	1	<b>1.10</b>	1.20	1.40
HIP215GPU	Purple	254 x 457mm	1.5mm	1	<b>1.60</b>	1.80	2.00
HIP220GPU	Purple	254 x 457mm	2mm	1	<b>2.20</b>	2.50	2.70
HIP310GPU	Purple	305 x 457mm	1mm	1	<b>1.25</b>	1.40	1.50
HIP315GPU	Purple	305 x 457mm	1.5mm	1	<b>1.65</b>	1.80	2.00
HIP320GPU	Purple	305 x 457mm	2mm	1	<b>2.30</b>	2.50	2.60
HIP510GPU	Purple	508 x 457mm	1mm	1	<b>2.15</b>	2.30	2.50
HIP515GPU	Purple	508 x 457mm	1.5mm	1	<b>3.30</b>	3.60	3.90
HIP520GPU	Purple	508 x 457mm	2mm	1	<b>4.55</b>	4.90	5.30
HIP610GPU	Purple	610 x 457mm	1mm	1	<b>2.40</b>	2.60	2.80
HIP615GPU	Purple	610 x 457mm	1.5mm	1	<b>3.40</b>	3.70	4.00
HIP620GPU	Purple	610 x 457mm	2mm	1	<b>4.55</b>	4.90	5.30

## High Impact Polystyrene (HIPS) Assorted Pack of 100



- For great value we have included the 100 assorted sheet pack containing 15 of each black and white, plus 10 of each of the other colours.

### Assorted High Impact Polystyrene (HIPS) Vacuum Forming Sheets

CODE	Colour	Sheet Size	Thickness	Unit	1+
HIP210SET	Assorted	254 x 457mm	1mm	1	<b>105.00</b>
HIP215SET	Assorted	254 x 457mm	1.5mm	1	<b>155.00</b>
HIP220SET	Assorted	254 x 457mm	2mm	1	<b>215.00</b>
HIP310SET	Assorted	305 x 457mm	1mm	1	<b>115.00</b>
HIP315SET	Assorted	305 x 457mm	1.5mm	1	<b>165.00</b>
HIP320SET	Assorted	305 x 457mm	2mm	1	<b>220.00</b>
HIP510SET	Assorted	508 x 457mm	1mm	1	<b>210.00</b>
HIP515SET	Assorted	508 x 457mm	1.5mm	1	<b>320.00</b>
HIP520SET	Assorted	508 x 457mm	2mm	1	<b>425.00</b>
HIP610SET	Assorted	610 x 457mm	1mm	1	<b>225.00</b>
HIP615SET	Assorted	610 x 457mm	1.5mm	1	<b>325.00</b>
HIP620SET	Assorted	610 x 457mm	2mm	1	<b>435.00</b>

## Laserable Engraving Laminate

- Suitable for interior and exterior signage, recognition or identification projects.
- An acrylic based product which is fully laserable, both cutting and engraving, ideal for school use.
- The first colour mentioned is the top face and the other colour will show through when engraved.
- Popular colours including gold and silver
- 610 x 305 x 1.5mm sheet size.

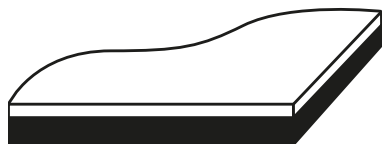

White on Black Laserable Engraving Laminate

CODE	Colour	Unit	4+	1+
ENL603WHB	White on Black	1	17.95	18.95

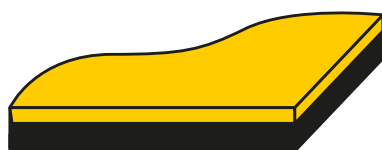

Yellow on Black Laserable Engraving Laminate

CODE	Colour	Unit	4+	1+
ENL603YLB	Yellow on Black	1	17.95	18.95



Black on White Laserable Engraving Laminate

CODE	Colour	Unit	4+	1+
ENL603BKW	Black on White	1	17.95	18.95

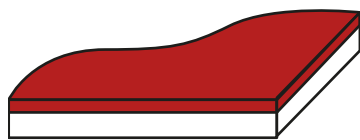

Red on White Laserable Engraving Laminate

CODE	Colour	Unit	4+	1+
ENL603RDW	Red on White	1	17.95	18.95

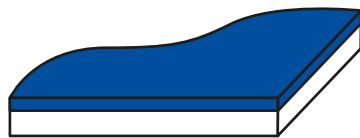

Blue on White Laserable Engraving Laminate

CODE	Colour	Unit	4+	1+
ENL603BUW	Blue on White	1	17.95	18.95

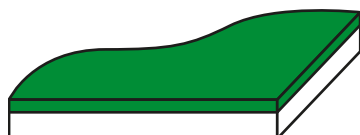

Green on White Laserable Engraving Laminate

CODE	Colour	Unit	4+	1+
ENL603GRW	Green on White	1	17.95	18.95

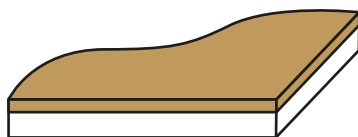

Gold on White Laserable Engraving Laminate

CODE	Colour	Unit	4+	1+
ENL603GLB	Gold on Black	1	17.95	18.95

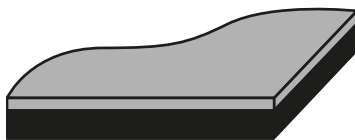

Silver on Black Laserable Engraving Laminate

CODE	Colour	Unit	4+	1+
ENL603SVB	Silver on Black	1	17.95	18.95

## Plastazote Coloured Sheets

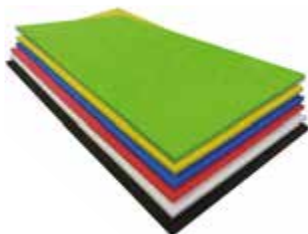

- Blown polyethylene foam with consistent cell structure and density, which has increased tear strength whilst being lightweight. Sheet size 1000 x 500mm.
- Impervious to most chemicals and water resistance
- Ideal for laser cutting, easily fabricated and can be thermoformed.
- Available in Red, Yellow, Green, Blue, Black and White.
- An assorted pack of 6 (one of each colour available) in either 3, 6 and 12mm thicknesses or single sheets.

### 1000 x 500mm

CODE	Thickness	Colour	Unit	4+	1+
PTZ103BLK	3mm	Black	1	3.60	3.90
PTZ103BLU	3mm	Blue	1	3.80	4.10
PTZ103GRN	3mm	Green	1	3.80	4.10
PTZ103RED	3mm	Red	1	3.80	4.10
PTZ103WHT	3mm	White	1	3.60	3.90
PTZ103YEL	3mm	Yellow	1	3.80	4.10
PTZ106BLK	6mm	Black	1	6.25	6.75
PTZ106BLU	6mm	Blue	1	6.75	7.25
PTZ106GRN	6mm	Green	1	6.75	7.25
PTZ106RED	6mm	Red	1	6.75	7.25
PTZ106WHT	6mm	White	1	6.25	6.75
PTZ106YEL	6mm	Yellow	1	6.75	7.25
PTZ112BLK	12mm	Black	1	10.95	11.95
PTZ112BLU	12mm	Blue	1	12.25	13.25
PTZ112GRN	12mm	Green	1	12.25	13.25
PTZ112RED	12mm	Red	1	12.25	13.25
PTZ112WHT	12mm	White	1	10.95	11.95
PTZ112YEL	12mm	Yellow	1	12.25	13.25

## Plastazote Assorted Coloured Sheets Pack of 6

### 1000 x 500mm

CODE	Thickness	Colour	Unit	1+
PTZ300SET	3mm	Assorted	Pack of 6	21.95
PTZ600SET	6mm	Assorted	Pack of 6	37.50
PTZ120SET	12mm	Assorted	Pack of 6	67.50

## Clear PETG Sheet



- PETG is also included in our Smart Materials section as a 'Shape Memory Plastic' that can be shaped by hand at room temperature to form a permanent bend, but will return to its original shape if heated.
- Very high impact strength and good optical clarity.
- Extremely easy to vacuum form or fabricate, without losing any of its toughness.
- Excellent chemical resistance.

### 600 x 400mm - 3mm Thickness

CODE	Colour	Unit	4+	1+
PTG640CLR	Clear	1	9.95	10.95

### 1000 x 500mm - 3mm Thickness

CODE	Colour	Unit	4+	1+
PTG105CLR	Clear	1	17.50	18.95

## Clear Polycarbonate Sheet



- High mechanical and thermal properties.
- A wide range of locations particularly in safety glazing and machine guarding.
- Excellent optical properties and brilliant surface.
- Virtually unbreakable and inflammable.
- Easy to vacuum form.

### 600 x 400mm - 3mm Thickness

CODE	Colour	Unit	4+	1+
PYC640CLR	Clear	1	10.95	12.50

### 1000 x 500mm - 3mm Thickness

CODE	Colour	Unit	4+	1+
PYC105CLR	Clear	1	20.95	21.95

## Corrugated Sheet Joiners

### Pack of 100



- Plastic components for joining pieces of 4mm thick Correx or similar sheet.
- The image shows a single frame of ten parts and our pack contains ten of these frames.
- Quick method for fast fabrication.
- Safe for younger students – no adhesive required.
- Can be re-used.

CODE	Description	Unit	10+	1+
CSJ100PAK	Sheet Joiners	Pack of 100	6.50	7.75

## Correx

### Pack of 10 or 5 Assorted

- A polypropylene corrugated sheet which is lightweight and tough.
- Can be glued, stitched, scored and welded.
- Ideal for modelmaking.
- Available in 3mm and 4mm thickness.
- Assorted pack of 5 - one of each colour.
- Size:1220 x 610mm.

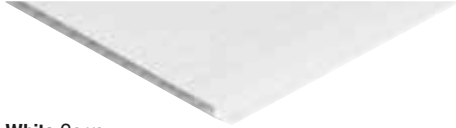

#### White Correx

CODE	Colour	Thickness	Unit	1+
CRX163FWH	White	3mm	Pack of 10	<b>31.95</b>
CRX164FWH	White	4mm	Pack of 10	<b>35.75</b>



#### Black Correx

CODE	Colour	Thickness	Unit	1+
CRX164FBK	Black	4mm	Pack of 10	<b>49.95</b>

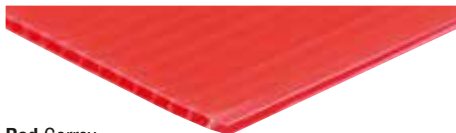

#### Red Correx

CODE	Colour	Thickness	Unit	1+
CRX164FRD	Red	4mm	Pack of 10	<b>49.95</b>

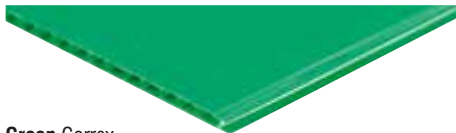

#### Green Correx

CODE	Colour	Thickness	Unit	1+
CRX164FGR	Green	4mm	Pack of 10	<b>49.95</b>

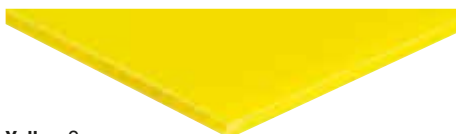

#### Yellow Correx

CODE	Colour	Thickness	Unit	1+
CRX164FYL	Yellow	4mm	Pack of 10	<b>49.95</b>

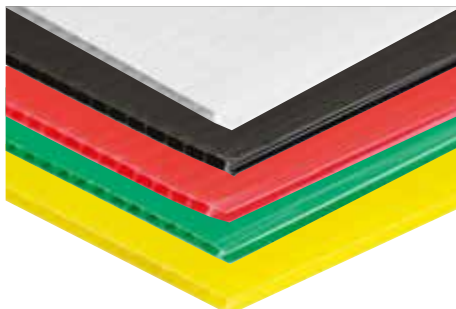

#### Assorted Correx

CODE	Colour	Thickness	Unit	1+
CRX164ASS	Assorted	4mm	Pack of 5	<b>25.95</b>

## Polypropylene Sheet

- For many applications in D&T, from fabrication to presentation.
- Flexible and can be scored to create a fold or hinge.
- Solid colour with a satin finish.
- Assorted pack of 12 contains 3 of each colour.
- 1100 x 650 - 0.75mm Thickness.



#### White Polypropylene Sheet

CODE	Colour	Unit	4+	1+
PYP168SWH	White	1	<b>5.25</b>	5.50



#### Black Polypropylene Sheet

CODE	Colour	Unit	4+	1+
PYP168SBK	Black	1	<b>5.25</b>	5.50



#### Yellow Polypropylene Sheet

CODE	Colour	Unit	4+	1+
PYP168SYL	Yellow	1	<b>9.50</b>	9.95



#### Red Polypropylene Sheet

CODE	Colour	Unit	4+	1+
PYP168SRD	Red	1	<b>9.50</b>	9.95



#### Green Polypropylene Sheet

CODE	Colour	Unit	4+	1+
PYP168SGR	Green	1	<b>9.50</b>	9.95



#### Blue Polypropylene Sheet

CODE	Colour	Unit	4+	1+
PYP168SBU	Blue	1	<b>9.50</b>	9.95



#### Assorted Polypropylene Sheets

CODE	Colour	Unit	1+
PYP168SST	Assorted 3 x each colour	Pack of 12	<b>99.50</b>

## PVC Foam Sheet

- Lighter in weight than solid PVC and often referred to by trade names such as 'Foamex' or 'Forex'.
- Ideal for CNC machining and thermo or vacuum forming.
- Easily cut, sawn, drilled, printed, painted, laminated, adhesive and mechanically fastened.
- Size:1220 x 610mm.
- Thickness: 3mm.



#### White PVC Foam Board

CODE	Colour	Unit	4+	1+
PVC126FWH	White	1	<b>10.75</b>	11.75



#### Black PVC Foam Board

CODE	Colour	Unit	4+	1+
PVC126FBK	Black	1	<b>11.75</b>	12.95



#### Red PVC Foam Board

CODE	Colour	Unit	4+	1+
PVC126FRD	Red	1	<b>11.75</b>	12.95



#### Blue PVC Foam Board

CODE	Colour	Unit	4+	1+
PVC126FBU	Blue	1	<b>11.75</b>	12.95



#### Green PVC Foam Board

CODE	Colour	Unit	4+	1+
PVC126FGR	Green	1	<b>11.75</b>	12.95



#### Yellow PVC Foam Board

CODE	Colour	Unit	4+	1+
PVC126FYL	Yellow	1	<b>11.75</b>	12.95

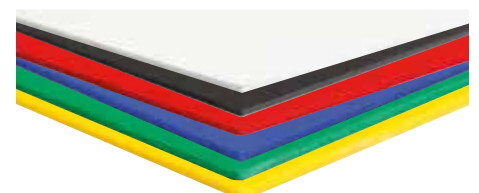

#### Assorted PVC Foam Board

CODE	Colour	Unit	1+
PVC126ASS	Assorted	Pack of 6	<b>58.50</b>

## Foam Board - White or Black

Pack of 10 or 20

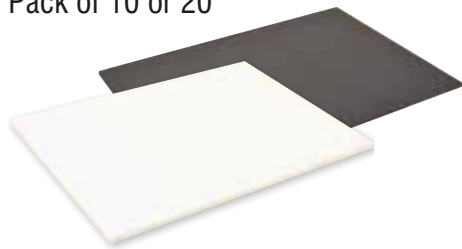

- Lightweight, rigid polystyrene foam board with a satin smooth surface.
- Ideal for model making and display mounting.
- Easily cut with a craft knife.
- A1 or A2.

### 5 mm Thickness

CODE	Description	Unit	4+	1+
FBA105WHT	A1 Foam Board	Pack of 10	<b>37.50</b>	39.50
FBA105BLK	A1 Foam Board	Pack of 10	<b>57.50</b>	59.95
FBA205WHT	A2 Foam Board	Pack of 20	<b>41.50</b>	43.50
FBA205BLK	A2 Foam Board	Pack of 20	<b>62.50</b>	65.50

## Modelling Foam



- Also known as Styrofoam.
- A stable material for modelling, prototyping, mould making and craft work.
- Can be easily cut, sanded and shaped by saw, chisel, knife or CNC machined.
- Fine closed cell structure provides a smooth surface that does not absorb water.

### 495 x 600mm - Various Thickness

CODE	Thickness	Size	Unit	4+	1+
STY025FBL	25mm	495 x 600mm	1	<b>7.25</b>	7.95
STY050FBL	50mm	495 x 600mm	1	<b>12.50</b>	13.75
STY075FBL	75mm	495 x 600mm	1	<b>18.95</b>	20.75
STY100FBL	100mm	495 x 600mm	1	<b>23.95</b>	26.50
STY165FBL	165mm	495 x 600mm	1	<b>30.95</b>	33.95

## Styrofoam Racing Car Blanks

Pack of 30



- Perfect size for making prototype racing cars - requires drilling for axles and propulsion canister.
- Can be easily cut, sanded and shaped by saw, chisel, knife or CNC machined.
- Fine closed cell structure provides a smooth surface that does not absorb water.
- Size 224 x 65 x 50mm.

### 500mm Length

CODE	Diameter	Unit	2+	1+
STY224CAR	Car Blank	Pack of 30	<b>34.50</b>	37.95

## Modelling Board – MHD 240



- A medium density polyurethane foam producing a smooth finish that's suited for sculpting and mould making - twice the density of the standard Styrofoam.
- Ideal for hand carving and shaping.
- Perfect for vacuum forming moulds.
- Can be both painted and glued.

### 250 x 250mm - 50mm Thickness

CODE	Density	Unit	4+	1+
MHD240MDN	240kg/m <sup>3</sup>	1	<b>28.95</b>	29.95

## Modelling Board MHD 600



- A fine cell, high density, polyurethane for prototyping applications - behaves like wood.
- High density 600kg/m<sup>3</sup> - will take a woodscrew.
- Ideal for CNC machining.
- Can be both painted and glued.

### 250 x 250mm - 50mm Thickness

CODE	Density	Unit	4+	1+
MHD600HDN	600kg/m <sup>3</sup>	1	<b>43.95</b>	45.95

## PET Roll Clear Rigid

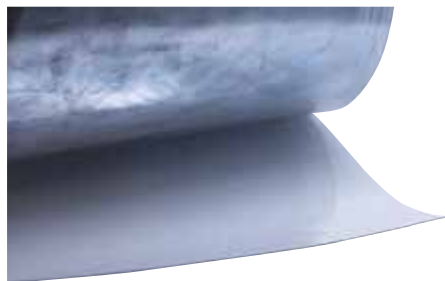

- PET is widely used for food containers and drink bottles - one of the most recycled plastics.
- A strong, lightweight plastic having a glass-like appearance.
- A 10kg roll in 545mm width with an approximate length of 27m and a thickness of 0.5mm.
- Use in cold forming only.
- If used in a heat application it does go milky in colour – hence the reduced price.

CODE	Colour	Unit	2+	1+
PET010CLR	Clear PET Roll	1	<b>59.50</b>	65.00

## PETg Clear Sheet



- Very high impact strength plastic with crystal clear transparency. Far superior to clear polystyrene (CHIPS) for strength and clarity.
- Easily thermoformed and vacuum formed without pre-drying.
- Suitable for hot or cold bending, printing, welding and fabrication.
- Food approved.

### 1.0mm Thickness

CODE	Size	Unit	20+	10+	1+
PET210CLR	254 x 457mm	1	<b>1.95</b>	2.10	2.25
PET310CLR	305 x 457mm	1	<b>2.25</b>	2.40	2.50
PET510CLR	508 x 457mm	1	<b>3.75</b>	4.25	4.95
PET610CLR	610 x 457mm	1	<b>3.95</b>	4.50	5.25

### 1.5mm Thickness

CODE	Size	Unit	20+	10+	1+
PET215CLR	254 x 457mm	1	<b>2.95</b>	3.25	3.50
PET315CLR	305 x 457mm	1	<b>2.95</b>	3.50	3.75
PET515CLR	508 x 457mm	1	<b>5.50</b>	6.50	7.50
PET615CLR	610 x 457mm	1	<b>5.95</b>	6.75	7.75

### 2.0mm Thickness

CODE	Size	Unit	20+	10+	1+
PET220CLR	254 x 457mm	1	<b>3.25</b>	3.50	3.75
PET320CLR	305 x 457mm	1	<b>3.75</b>	4.25	4.75
PET520CLR	508 x 457mm	1	<b>7.50</b>	8.50	9.25
PET620CLR	610 x 457mm	1	<b>7.75</b>	8.75	9.75

## Clear Rigid PVC Roll



- Economical clear plastic sheet on a roll used for forming blister packaging and other thermoforming operations.
- A 10kg roll in 545mm width with an approximate length of 27m and a thickness of 0.5mm.
- Virgin food grade PVC.
- Easy to vacuum form.

### 545mm x 27m - 0.5mm Thickness

CODE	Description	Unit	2+	1+
PVC010CLR	Clear Rigid PVC Roll	1	<b>72.50</b>	79.50

Timber

## Meditate Laserable MDF Sheets

Pack of 10 or 5



- Laserable grade MDF.
- Available in numerous dimensions to suit most laser cutters.
- Sizes and thicknesses are nominal.
- We supply our sheets in packs to avoid warping.

### Various Sizes

CODE	Size	Unit	4+	1+
MDF363P10	600 x 300 x 3.2mm	Pk 10	<b>15.95</b>	17.50
MDF364P10	600 x 400 x 3.2mm	Pk 10	<b>21.50</b>	23.75
MDF384P10	800 x 450 x 3.2mm	Pk 10	<b>41.95</b>	46.25
MDF342P10	1220 x 610 x 3.2mm	Pk 10	<b>62.50</b>	68.75
MDF463P10	600 x 300 x 4mm	Pk 10	<b>30.75</b>	33.75
MDF464P10	600 x 400 x 4mm	Pk 10	<b>38.75</b>	42.50
MDF484P10	800 x 450 x 4mm	Pk 10	<b>72.75</b>	80.00
MDF442P10	1220 x 610 x 4mm	Pk 10	<b>120.50</b>	132.50
MDF663P10	600 x 300 x 6mm	Pk 10	<b>32.95</b>	36.25
MDF664P10	600 x 400 x 6mm	Pk 10	<b>43.25</b>	47.50
MDF684P10	800 x 450 x 6mm	Pk 10	<b>86.50</b>	95.00
MDF642P10	1220 x 610 x 6mm	Pk 10	<b>129.75</b>	142.50
MDF963P05	600 x 300 x 9.0mm	Pk 5	<b>26.25</b>	28.75
MDF964P05	600 x 400 x 9.0mm	Pk 5	<b>39.25</b>	43.13
MDF984P05	800 x 450 x 9.0mm	Pk 5	<b>56.25</b>	61.88
MDF942P05	1200 x 610 x 9.0mm	Pk 5	<b>84.25</b>	92.50
MDF163P05	600 x 300 x 12.0mm	Pk 5	<b>24.95</b>	27.50
MDF164P05	600 x 400 x 12.0mm	Pk 5	<b>33.50</b>	36.88
MDF184P05	800 x 450 x 12.0mm	Pk 5	<b>66.95</b>	73.75
MDF142P05	1200 x 610 x 12.0mm	Pk 5	<b>99.95</b>	110.00

## Birch Plywood Sheets

Pack of 10 or 5

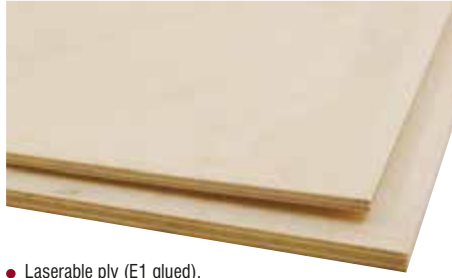

- Laserable ply (E1 glued).
- Available in numerous dimensions to suit most laser cutters.
- Sizes and thicknesses are nominal.
- We supply our sheets in packs to avoid warping.

Please note this is a natural product and it can be affected by heat or humidity. It may be necessary for the wood to be taped to the laser bed.

### Various Sizes

CODE	Size	Unit	4+	1+
BPY363P10	600 x 300 x 3mm	Pack of 10	<b>30.95</b>	33.95
BPY364P10	600 x 400 x 3mm	Pack of 10	<b>39.95</b>	43.95
BPY384P10	800 x 450 x 3mm	Pack of 10	<b>67.95</b>	74.75
BPY463P10	600 x 300 x 4mm	Pack of 10	<b>37.95</b>	41.75
BPY464P10	600 x 400 x 4mm	Pack of 10	<b>49.95</b>	54.95
BPY484P10	800 x 450 x 4mm	Pack of 10	<b>75.95</b>	83.50
BPY663P10	600 x 300 x 6mm	Pack of 10	<b>55.95</b>	61.50
BPY664P10	600 x 400 x 6mm	Pack of 10	<b>74.95</b>	82.50
BPY684P10	800 x 450 x 6mm	Pack of 10	<b>112.50</b>	123.75
BPY963P05	600 x 300 x 9mm	Pack of 5	<b>41.50</b>	45.75
BPY964P05	600 x 400 x 9mm	Pack of 5	<b>55.50</b>	61.00
BPY984P05	800 x 450 x 9mm	Pack of 5	<b>82.95</b>	91.25
BPY163P05	600 x 300 x 12mm	Pack of 5	<b>54.95</b>	60.50
BPY164P05	600 x 400 x 12mm	Pack of 5	<b>72.50</b>	79.75
BPY184P05	800 x 450 x 12mm	Pack of 5	<b>108.50</b>	119.50

## Poplar Laser Ply

Pack of 24, 10 or 5



- Light colour timber with imperceptible grain.
- Lighter weight than birch.
- Available in numerous dimensions to suit most laser cutters.
- Sizes and thicknesses are nominal.
- Assorted Pack: 24 x 600 x 300mm sheets - 12 x 3mm and 12 x 6mm thicknesses.

### Various Sizes

CODE	Size	Unit	4+	1+
PPY363P10	600 x 300 x 3mm	Pk 10	<b>19.50</b>	20.95
PPY364P10	600 x 400 x 3mm	Pk 10	<b>25.95</b>	27.95
PPY396P10	900 x 600 x 3mm	Pk 10	<b>58.50</b>	62.95
PPY463P10	600 x 300 x 4mm	Pk 10	<b>23.95</b>	26.95
PPY464P10	600 x 400 x 4mm	Pk 10	<b>31.95</b>	35.95
PPY496P10	900 x 600 x 4mm	Pk 10	<b>71.95</b>	80.95
PPY663P10	600 x 300 x 6mm	Pk 10	<b>28.50</b>	32.25
PPY664P10	600 x 400 x 6mm	Pk 10	<b>37.95</b>	42.95
PPY696P10	900 x 600 x 6mm	Pk 10	<b>85.50</b>	96.75
PPY963P05	600 x 300 x 9mm	Pk 5	<b>24.95</b>	27.50
PPY964P05	600 x 400 x 9mm	Pk 5	<b>33.50</b>	36.75
PPY996P05	900 x 600 x 9mm	Pk 5	<b>99.95</b>	110.00
PPY163P05	600 x 300 x 12mm	Pk 5	<b>28.50</b>	31.25
PPY164P05	600 x 400 x 12mm	Pk 5	<b>38.25</b>	42.00
PPY196P05	900 x 600 x 12mm	Pk 5	<b>114.50</b>	126.00
PPY306ASS	600 x 300 x 3&6mm	Pk 24		<b>55.00</b>

## Flexi-Ply



- Unique quality ply which solves otherwise complex timber structures.
- Laminations are arranged in such a way to enable the ply to be curved or formed without excessive pressure.
- Can be clamped manually, also ideal for use with the Bagpress system.
- Sizes and thicknesses are nominal.

### 600mm x 600mm

CODE	Size	Unit	4+	1+
PLY366FLX	3 x 600 x 600mm	1	<b>9.50</b>	9.95
PLY566FLX	5 x 600 x 600mm	1	<b>11.50</b>	11.95
PLY866FLX	8 x 600 x 600mm	1	<b>13.50</b>	13.95

## Thin Birch Laserable Ply



- Extra thin quality ply to form curves.
- Can be laminated to flexi-ply to hold the shape and provide a birch surface.

### 300 x 200mm, 600 x 300mm, 500 x 500 and 600mm x 600mm

CODE	Size	Unit	4+	1+
BPY082ETH	0.8 x 300 x 200mm	1	<b>4.25</b>	4.50
BPY083ETH	0.8 x 600 x 300mm	1	<b>7.95</b>	8.95
BPY085ETH	0.8 x 500 x 500mm	1	<b>10.25</b>	11.50
BPY086ETH	0.8 x 600 x 600mm	1	<b>16.75</b>	17.95
BPY152ETH	1.5 x 300 x 200mm	1	<b>4.25</b>	4.50
BPY155ETH	1.5 x 500 x 500mm	1	<b>7.95</b>	8.95
BPY153ETH	1.5 x 600 x 300mm	1	<b>10.25</b>	11.50
BPY156ETH	1.5 x 600 x 600mm	1	<b>16.75</b>	17.95

## Oak Veneered MDF



- Ideal where a stable panel is required.
- Veneered with crown cut American Oak on both sides.

### 1200 x 600mm

CODE	Thickness	Unit	4+	1+
PLY1260OAK	6mm	1	<b>34.95</b>	38.50
PLY1290OAK	9mm	1	<b>41.50</b>	45.50

Please note these are natural products and can be affected by heat or humidity. It may be necessary for the wood to be taped to the laser bed.

## Wood Veneers 10sqft Pack



- Convenient packs of selected veneers supplied in trimmed lengths of between 3ft (915mm) and 4ft (1220mm).
- The edges are guillotined straight and the veneer is ready for laying and jointing.
- The veneers are consecutive, and have an approximate coverage of 10 sq. ft. (0.93 sq.m).
- Ready to use, sorted and trimmed veneer leaves.
- Obtained from sustainable sources to protect environment.
- Ideal for restoration work, antiques, furniture construction and conservation.

### 10sq.ft. Pack

CODE	Description	Unit	4+	1+
WVP010SPC	Sapele (Crowncut)	Pack	<b>15.95</b>	17.50
WVP010OAK	Oak	Pack	<b>22.75</b>	25.25
WVP010MAP	Maple	Pack	<b>30.50</b>	33.75
WVP010WAL	Walnut	Pack	<b>29.75</b>	33.00

## Joinery Grade Timber Pack of 5



- High quality redwood for joinery, furniture and projects.
- Sold as a 6 metre pack of 5 x 1.2m lengths.
- Available in 50, 75, 100, 150 and 200mm nominal widths.
- All in 25mm nominal thickness = 21mm +/- 1mm.

### 1200mm Length

CODE	Actual Size	Unit	4+	1+
TMB052JGR	45 x 21mm	Pack of 5	<b>12.95</b>	15.50
TMB072JGR	70 x 21mm	Pack of 5	<b>20.75</b>	22.95
TMB102JGR	98 x 21mm	Pack of 5	<b>27.25</b>	29.50
TMB152JGR	148 x 21mm	Pack of 5	<b>39.95</b>	42.50
TMB202JGR	200 x 21mm	Pack of 5	<b>49.95</b>	53.95

## Balsa Economy Pack



- Great value - small bundle of balsa sheets and shapes for modelling.
- Balsa lengths 150mm (6").
- Pack measures 150mm (6") x 150mm (6") x 50mm (2").

CODE	Size mm	Unit	4+	1+
BLP662ECN	Economy	1	<b>10.95</b>	11.95

## Balsa Thin Sections

Pack of 30



- 10 lengths x 1.6mm thickness
- 5 lengths x 2.4mm thickness
- 5 lengths x 3.2mm thickness
- 5 lengths x 4.8mm thickness
- 5 lengths x 6.4mm thickness

### 450mm Length

CODE	Size	Unit	2+	1+
BLP075THN	75mm wide	Pack of 30	<b>28.50</b>	35.50
BLP100THN	100mm wide	Pack of 30	<b>29.75</b>	36.00

## Balsa Thick Sections

Pack of 10



- 5 lengths x 9.6mm thickness
- 5 lengths x 12.6mm thickness

### 450mm Length

CODE	Size	Unit	2+	1+
BLP075TCK	75mm wide	Pack of 10	<b>27.00</b>	34.25
BLP100TCK	100mm wide	Pack of 10	<b>27.25</b>	35.00

## Balsa Block Sections

Pack of 16



- 10 lengths x 25 x 25mm
- 6 lengths x 25 x 50mm

### 450mm Length

CODE	Description	Unit	2+	1+
BLP450BLC	Block Sections	Pack of 16	<b>33.25</b>	40.25

## Balsa Square Sections Pack of 160



- 30 lengths x 1.6 x 1.6mm
- 30 lengths x 2.4 x 2.4mm
- 20 lengths x 3.2 x 3.2mm
- 30 lengths x 4.8 x 4.8mm
- 30 lengths x 6.4 x 6.4mm
- 10 lengths x 9.6 x 9.6mm
- 10 lengths x 12.6 x 12.6mm

### 450mm Length

CODE	Description	Unit	2+	1+
BLP160SQU	Square Sections	Pack of 160	<b>32.50</b>	38.75

## Balsa Rectangle Sections Pack of 100



- 20 lengths x 6.4 x 12.6mm
- 30 lengths x 3.2 x 6.4mm
- 20 lengths x 3.2 x 9.6mm
- 20 lengths x 3.2 x 12.6mm
- 10 lengths x 6.4 x 25mm

### 450mm Length

CODE	Description	Unit	2+	1+
BLP100REC	Rectangle Sections	Pack of 100	<b>32.00</b>	37.75

## Balsa Pack Super Thin

Pack of 50



- 50 lengths x 1.6mm thick x 100mm wide.

### 450mm Length

CODE	Description	Unit	2+	1+
BLP116STH	Super Thin Sections	Pack of 50	<b>29.50</b>	35.50

## Balsa Carving Block Pack



- Great value - small bundle of balsa wood blocks for carving and shaping.
- Block lengths 75mm (3").
- Pack measures 150mm (6") x 150mm (6") x 50mm (2").

CODE	Size mm	Unit	4+	1+
BLP662CVB	Carving Block	1	<b>9.50</b>	10.95

Timber

## Hardwood Dowels Bulk

Packs of 100, 50, 20 and 10



600mm Length

CODE	Size	Unit	4+	1+
DOW003020	3mm	Pack of 20	1.00	1.25
DOW003100	3mm	Pack of 100	4.75	4.95
DOW004020	4mm	Pack of 20	1.25	1.50
DOW004100	4mm	Pack of 100	5.75	5.95
DOW005020	5mm	Pack of 20	1.75	2.25
DOW005100	5mm	Pack of 100	8.25	8.50
DOW006020	6mm	Pack of 20	2.00	2.25
DOW006100	6mm	Pack of 100	8.75	8.95
DOW008010	8mm	Pack of 10	1.50	1.75
DOW008050	8mm	Pack of 20	7.50	7.95
DOW010010	10mm	Pack of 10	2.00	2.25
DOW010050	10mm	Pack of 50	9.75	9.95
DOW012020	12mm	Pack of 20	9.50	9.75
DOW015020	15mm	Pack of 20	13.00	13.75
DOW018010	18mm	Pack of 10	10.75	10.95
DOW022010	22mm	Pack of 10	15.95	16.50
DOW025010	25mm	Pack of 10	17.95	18.95

## Hardwood Dowels Assortment

Packs of 100, 120 or 300



Pack A

100 x 4mm, 100 x 5mm and 100 x 6mm

CODE	Description	Unit	1+
DOW456PAK	Pack A - Assorted Dowels	Pack of 300	19.95

Pack B

50 x 8mm, 50 x 10mm and 20 x 12mm

CODE	Description	Unit	1+
DOW812PAK	Pack B - Assorted Dowels	Pack of 120	24.95

Pack C

20 x 3mm, 20 x 4mm, 20 x 5mm, 20 x 6mm, 10 x 8mm and 10 x 10mm

CODE	Description	Unit	1+
DOW100ASS	Pack C - Assorted Dowels	Pack of 100	8.95

## Hardwood Squares

Packs of 100, 50 and 25



600mm Length

CODE	Description	Unit	4+	1+
HSQ606100	6 x 6mm	Pack of 100	16.95	18.25
HSQ808100	8 x 8mm	Pack of 100	27.50	29.50
HSQ101050	10 x 10mm	Pack of 50	18.50	19.95
HSQ121250	12 x 12mm	Pack of 50	22.75	25.25
HSQ151550	15 x 15mm	Pack of 50	34.75	37.25
HSQ212125	21 x 21mm	Pack of 25	29.95	32.25

## Softwood Squares

Pack of 100



600mm Length

CODE	Size	Unit	4+	1+
SSQ606100	6 x 6mm	Pack of 100	12.50	13.95
SSQ808100	8 x 8mm	Pack of 100	15.95	17.50
SSQ100100	10 x 10mm	Pack of 100	22.95	24.95
SSQ120100	12 x 12mm	Pack of 100	32.50	34.95

## Softwood Rectangles

Pack of 100



600mm Length

CODE	Size	Unit	4+	1+
SRC155PAK	15 x 5mm	Pack of 100	18.95	20.50
SRC255PAK	25 x 5mm	Pack of 100	29.75	32.50

## Hardwood Craft Pack

Standard Set



- An invaluable resource, a large assorted box of 600mm long hardwood sections.
- Supplied as a Standard selection across the range.

600mm Length

CODE	Description	Unit	1+
HCP001STD	Standard Set	Assorted Pack	45.00

## Hardwood Craft Pack

Structural Set



- An invaluable resource, a large box of 600mm long hardwood sections.
- Supplied as a Structural (smaller sizes) selection.

600mm Length

CODE	Description	Unit	1+
HCP002STR	Structural Set	Pack	45.00

## Hardwood Craft Pack

Block Set



- An invaluable resource, a large box of 600mm long hardwood sections.
- Supplied as a Block (larger sizes) selection.

600mm Length

CODE	Description	Unit	1+
HCP003BLC	Block Set	Pack	48.75



## MDF Model Bases

Pack of 10

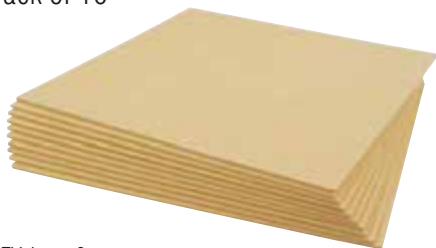

- Thickness 3mm.

150 x 150mm and 300 x 300mm Length

CODE	Size	Unit	4+	1+
MMB150P10	150 x 150mm	Pack of 10	5.75	6.25
MMB300P10	300 x 300mm	Pack of 10	11.50	12.50

## MDF Clock Faces

Pack of 10



CODE	Description	Unit	4+	1+
RCF150P10	Round 170mm	Pack of 10	7.95	9.25
SCF150P10	Square 150mm	Pack of 10	8.50	9.50

## Clock Movements and Hands

Single or Pack of 20



- Precision quartz movement.
- Supplied with hands.
- Accommodates material thickness up to 10mm.
- Requires AA battery, not included.
- Spindle diameter is 7.6mm to suit an 8mm hole.

CODE	Unit	50+	10+	1+
CLM001HND	1	1.10	1.25	1.75
CLM020PAK	Pack of 20			22.50

## Bamboo Sheet Pack of 5



- A sustainable and renewable resource – one of the fastest growing plants in the world.
- Strips of bamboo are cut and pressed to form a sheet which can be laser cut or worked by hand.
- Please note, as this is a natural product it will be affected by heat and humidity. It may be necessary to be taped down when laser cutting.

CODE	Description	Unit	4+	1+
BAM643PAK	600 x 400 3mm	Pack of 5	19.95	22.95
BAM645PAK	600 x 400 5mm	Pack of 5	29.95	34.95

## Birch Ball

Pack of 10



CODE	Diameter	Unit	4+	1+
BBL12PK10	12mm	Pack of 10	2.25	3.00
BBL25PK10	25mm	Pack of 10	3.75	4.50
BBL38PK10	38mm	Pack of 10	6.25	6.75
BBL50PK10	50mm	Pack of 10	11.25	12.25

## Birch Pulley

Pack of 10



- 4mm diameter hole.
- Thickness 10mm.

CODE	Size	Unit	4+	1+
BPU20PK10	20mm	Pack of 10	2.25	3.00
BPU30PK10	30mm	Pack of 10	2.75	3.25
BPU40PK10	40mm	Pack of 10	5.00	6.25
BPU50PK10	50mm	Pack of 10	5.75	7.00

## Birch Wheel

Pack of 10



- 4mm diameter hole.
- Thicknesses: 7mm (25mm), 12mm (38mm) and 14mm (50mm).

CODE	Diameter	Unit	4+	1+
BWH25PK10	25mm	Pack of 10	2.25	3.00
BWH38PK10	38mm	Pack of 10	3.00	3.50
BWH50PK10	50mm	Pack of 10	4.25	5.25

## MDF Wheel

Pack of 100



- 4mm diameter hole.
- Thickness 6mm.

CODE	Size	Thickness	Unit	4+	1+
MWH025100	25mm	6mm	Pk 100	5.95	7.25
MWH038100	38mm	6mm	Pk 100	6.25	7.50
MWH050100	50mm	6mm	Pk 100	8.95	9.95
MWH060100	60mm	6mm	Pk 100	9.95	11.75

## Chrome Steel Ball Bearings

Pack of 100



- Chrome steel ball bearings for all bearing applications.
- Ideal for school projects.
- Hardened to HRC60-66 degree.

CODE	Size	Unit	4+	1+
SBB103PAK	3mm	Pack of 100	3.25	3.95
SBB104PAK	4mm	Pack of 100	3.95	4.75
SBB105PAK	5mm	Pack of 100	4.50	5.50
SBB106PAK	6mm	Pack of 100	6.50	7.95
SBB108PAK	8mm	Pack of 100	8.95	9.95
SBB110PAK	10mm	Pack of 100	10.50	11.95

## Key Rings

Pack of 100 & 1000



- Popular accessory to compliment a key fob
- Split type, nickel plated steel.

25mm Diameter

CODE	Unit	5+	2+	1+
KYR125PAK	Pack of 100	5.50	5.75	5.95
KYR025BPK	Pack of 1000		28.95	29.95

## Cork Sheet



- Sheet cork for modelling and craft activities.
- Can be laser cut.
- Thicknesses 1.5mm and 3mm - supplied in a roll.

600 x 900mm

CODE	Thickness	Unit	4+	1+
CRK691SHT	1.5mm	1	4.95	5.95
CRK693SHT	3mm	1	9.95	10.95

## Double Sided Plastic Mirror

Pack of 5



- Double-sided plastic plane mirrors with high quality finish.
- Both sides protected with peel off film.
- Can be bent or cut easily for creative art and craft projects.

300 x 200mm

CODE	Size	Unit	4+	1+
MRR320SD	300 x 200mm	1	25.25	27.95

## Grey Standard Laserable Rubber Sheet A4



- The first type of laser rubber, launched on the international market in 1998.
- Can be engraved and cut with any type of CO<sub>2</sub> laser - this is the standard product you must use extraction to remove the smell when laser cutting.
- Outstanding engraving and impression quality.
- Suitable for single colour and multi colour stamps with alcohol and water based ink resistance.
- A4 size in a 2.3mm thickness.

CODE	Colour	Unit	4+	1+
LRS400GRY	Standard	1	<b>6.50</b>	6.95

## Yellow No-smell Laserable Rubber Sheet A4



- An enhanced version of laser rubber which produces no smell when used on a laser cutter.
- The yellow no-smell rubber can be engraved and cut with any type of CO<sub>2</sub> laser.
- Outstanding engraving and impression quality.
- Suitable for single colour and multi colour stamps with alcohol and water based ink resistance.
- A4 size in a 2.3mm thickness.

CODE	Colour	Unit	4+	1+
LRS400YEL	No-smell	1	<b>11.95</b>	12.50

## Silver Steel Pack of 10 or 5



- Made to fine tolerances with exceptional finish.
- Closely controlled analysis for consistency, uniform machining and heat treatment properties.

### 333mm Length

CODE	Diameter	Unit	2+	1+
STU002SLS	2mm	Pack of 10	<b>6.00</b>	6.75
STU003SLS	3mm	Pack of 10	<b>9.50</b>	10.75
STU004SLS	4mm	Pack of 10	<b>12.25</b>	14.00
STU005SLS	5mm	Pack of 10	<b>16.75</b>	19.50
STU006SLS	6mm	Pack of 10	<b>23.50</b>	27.00
STU008SLS	8mm	Pack of 10	<b>31.50</b>	33.75
STU010SLS	10mm	Pack of 5	<b>25.25</b>	28.00
STU012SLS	12mm	Pack of 5	<b>31.50</b>	33.75

## Bright Mild Steel Flat Pack of 10



### 25mm Width x 500mm Length

CODE	Size	Unit	1+
BMS0325FL	3mm	Pack of 10	<b>21.95</b>
BMS0625FL	6 mm	Pack of 10	<b>47.75</b>
BMS1025FL	10mm	Pack of 10	<b>52.00</b>

## Bright Mild Steel Rod Pack of 10

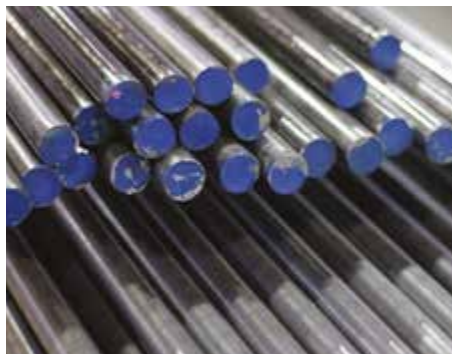

### 500mm Length

CODE	Diameter	Unit	5+	1+
BMS04ROD	4mm	Pack of 10	<b>7.75</b>	8.50
BMS05ROD	5mm	Pack of 10	<b>8.25</b>	8.75
BMS06ROD	6mm	Pack of 10	<b>8.50</b>	9.25
BMS08ROD	8mm	Pack of 10	<b>10.00</b>	11.25

## Brass Rod



### 500mm Length

CODE	Diameter	Unit	5+	1+
BRS005ROD	5mm	1	<b>3.25</b>	4.25
BRS006ROD	6mm	1	<b>3.50</b>	4.50
BRS008ROD	8mm	1	<b>4.50</b>	5.25
BRS010ROD	10mm	1	<b>4.95</b>	5.95

## Aluminium Rod



### 500mm Length

CODE	Diameter	Unit	5+	1+
ALU506ROD	6.5mm	1	<b>2.25</b>	2.50
ALU508ROD	8mm	1	<b>2.40</b>	2.50
ALU510ROD	10mm	1	<b>2.50</b>	2.95
ALU516ROD	16mm	1	<b>6.50</b>	7.50
ALU520ROD	20mm	1	<b>9.75</b>	10.50
ALU525ROD	25mm	1	<b>15.25</b>	16.50

## Lead Free Pewter



- Lead free pewter which is ideally suited for casting applications such as the Flamefast System.
- Supplied in a 1 kg ingot.
- Melts at 245°C.

CODE	Description	Unit	4+	1+
PEW100LFR	Lead Free Pewter	1	<b>47.95</b>	49.95

## Brushed Aluminium Composite Sheet



- A 0.3mm aluminium faced composite sheet with a polyethylene core.
- One aluminium face has a brushed finish, the other is plain.
- Ideal for fabricating.
- Lightweight, durable and strong.
- Easily machined on a CNC router.

### 605 x 1220mm - 3mm Thickness

CODE	Colour	Unit	4+	1+
BAC163ALU	Brushed Aluminium	1	<b>35.75</b>	38.50

## Copper Sheet

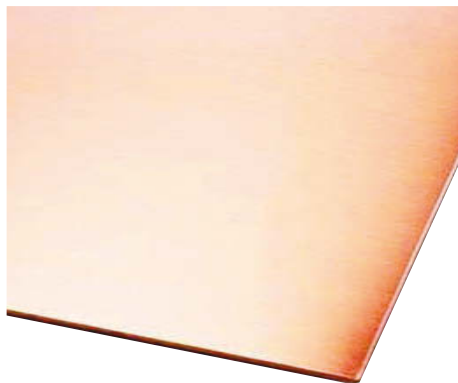

150 x 200mm

CODE	Thickness	Size	Unit	5+	1+
COP152SHT	20 Gauge	0.9mm	1	<b>7.25</b>	9.95

500 x 500mm

CODE	Thickness	Size	Unit	1+
COP200SHT	20 Gauge	0.9mm	1	<b>56.25</b>

## Aluminium Sheet

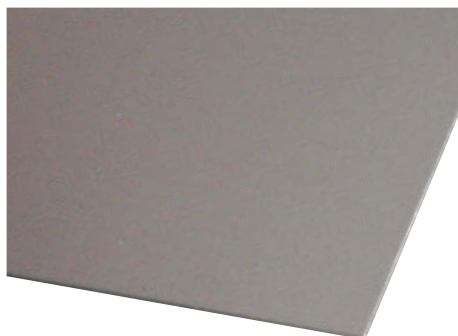

150 x 200mm

CODE	Thickness	Size	Unit	5+	1+
ALU152SHT		3mm	1	<b>3.50</b>	4.25

500 x 500mm

CODE	Thickness	Size	Unit	5+	1+
ALU100SHT		1mm	1	<b>9.75</b>	12.95
ALU300SHT		3mm	1	<b>22.95</b>	27.00

## Brass Sheet



150 x 200mm

CODE	Thickness	Size	Unit	5+	1+
BRS152SHT	20 Gauge	0.9mm	1	<b>6.75</b>	8.95

500 x 500mm

CODE	Thickness	Size	Unit	1+
BRS220SHT	22 Gauge	0.7mm	1	<b>49.95</b>
BRS200SHT	20 Gauge	0.9mm	1	<b>54.95</b>
BRS190SHT	19 Gauge	1.0mm	1	<b>57.95</b>
BRS180SHT	18 Gauge	1.2mm	1	<b>59.95</b>

## Small Metal Sheet Assortment Aluminium, Brass and Copper Pack of 6

- Popular small sized sheet, ideal for D&T projects where the cost of a large sheet is prohibitive.

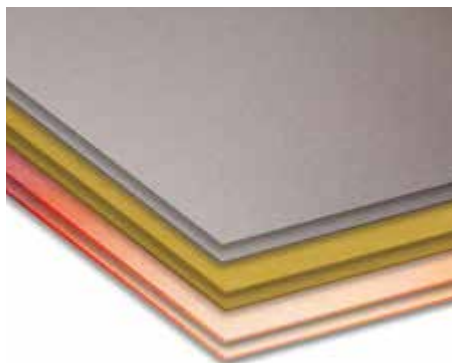

150 x 200mm

CODE	Description /Thickness	Unit	1+
ABC152ASS	Assorted (2 of each kind)	Pack of 6	<b>49.50</b>

## Thermochromic Self Adhesive Sheet Material



- A remarkable self adhesive sheet material printed with thermochromic liquid crystal 'ink'. Changes colour (bright blue) when heated above 27°C.
- Potential applications are many and varied – e.g. temperature indication/warnings, body jewellery, advertising displays (attach a resistance wire to the rear and pass a small current to cause dramatic colour changes to the front 'screen').
- Note: typical applications require only very small pieces – e.g. 25mm x 25mm.

CODE	Size	Unit	1+
SMM150TCM	150 x 150mm	1	<b>7.95</b>
SMM450TCM	300 x 450mm	1	<b>47.95</b>

## Shape Memory Plastic



- This amazing plastic can be shaped by hand at room temperature to form a permanent bend - no need for ovens or strip heaters.
- It looks just like acrylic but has a toughness approaching polycarbonate.
- It is also a shape-memory polymer, so it will return to its original shape when heated – e.g., in very hot water.

3mm Thickness

CODE	Size	Unit	1+
SMM530SMP	500 x 300mm	1	<b>7.75</b>
SMM106SMP	1000 x 600mm	1	<b>37.25</b>

## Easy-Cutting Machinable Plastic Wax Bar or Block



- Specially developed for machining operations on both manual and CNC lathes, milling machines, routers etc.
- Can be drilled, reamed, milled, threaded, turned, chamfered, sawn, moulded, carved, polished, glued and re-cycled.
- Easier to machine than metal, wood or foam, without sacrificing finish, quality or accuracy of any dimension.
- Unlike PVC, MDF or wood there is little clogging of cutters and no hazardous dust, also minimal tool wear as the material is self-lubricating and non-abrasive.
- Machinable plastic wax has safety and environmental advantages - It does not produce sharp swarf and does not require cutting fluids.

CODE	Size	Unit	3+	1+
MPW252BAR	Bar 25 dia x 250mm	1	<b>10.75</b>	11.95
MPW352BAR	Bar 35 dia x 250mm	1	<b>13.75</b>	15.25
MPW452BAR	Bar 45 dia x 250mm	1	<b>19.95</b>	22.25
MPW552BAR	Bar 55 dia x 250mm	1	<b>28.95</b>	32.25
MPW801BAR	Bar 80 dia x 100mm	1	<b>25.25</b>	28.00
MPW941BLK	Block 90 x 40 x 150mm	1	<b>28.50</b>	31.50
MPW991BLK	Block 90 x 90 x 150mm	1	<b>62.95</b>	69.95
MPW511BLK	Block 55 x 100 x 100mm	1	<b>25.75</b>	28.50
MPW111BLK	Block 110 x 150 x 150mm	1	<b>107.50</b>	119.50
MPW131BLK	Block 170 x 30 x 100mm	1	<b>29.50</b>	32.75

## Polymorph



- An invaluable material in model making and prototyping.
- Has the characteristics of a tough engineering material, yet it fuses and becomes easily mouldable at just 65°C.
- Can be heated and re-heated with hot water or a hairdryer, then moulded by hand.
- Coloured by adding food dye when soft.

Uses for Polymorph include:

- Moulding of handles and orthopaedic aids.
- Vacuum forming moulds.
- Moulds for batch producing other mouldings.
- Prototype mechanical parts.
- Armatures / frames for models.
- Inserts for compliant products.
- Specialised components – e.g. motor mountings.
- Moulding of complete products – e.g. torches.
- Joining components together.

CODE	Weight	Unit	1+
SMM250PLM	250g	Pack	<b>8.75</b>
SMM001PLM	1kg	Pack	<b>32.95</b>

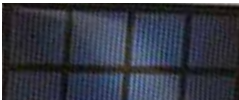
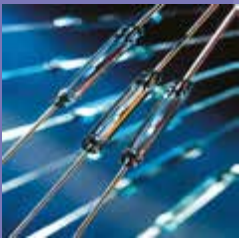

# Kits & Components

---

**Construction Kits**  
29-31

---

**Environmental Meters**  
32

---

**Components**  
33-43

---

**Batteries**  
44

### K'Nex Education Introduction to Levers and Pulleys 78610

Age 8+, builds 8 models, 2-3 students



- Ideal for delivering the design and technology curriculum - identifying 3 classes of levers and pulley systems.
- 178 pieces to build 8 real working models of 1st, 2nd and 3rd class levers and fixed moveable and combination pulley systems.
- Set supports a team of 2-3 pupils for Key Stage 2.
- Detailed teachers guide with key concepts, terms definitions and learning objectives and lesson plans included.

CODE	Description	Unit	1+
KNX610LAP	Introduction to Levers & Pulleys	1	34.75

### K'Nex Education Introduction to Gears 78630

Age 8+, builds 7 models, supports 2-3 students



- Allows students to explore how different types of gears work and the concept of gearing up and gearing down.
- 198 pieces to build 7 different gear models, including 2 spur gear, 2 crown gear and 2 chain socket gear examples.
- Models include Egg Beater, Blender, Chainsaw, Record Player, Crank Fan, Car Window and Exercise Bike.
- Set supports a team of 2-3 students for Key Stage 2.
- Detailed teachers guide with key concepts, terms definitions and learning objectives and lesson plans included.

CODE	Description	Unit	1+
KNX630GEA	Introduction to Gears	1	34.75

### K'Nex Education Introduction to Structures - Bridges 78640

Age 8+, builds 13 models, supports 2-3 students



- Allows students to explore the characteristics and purposes of seven different bridge types.
- Explore how different types of bridges hold their load and their strength and stability.
- 207 K'Nex parts to build 13 fully functioning replicas
- Detailed teachers guide with key concepts, terms definitions, learning objectives and lesson plans included.

CODE	Description	Unit	1+
KNX640SBR	Introduction to Structures - Bridges	1	34.75

### K'Nex Education Introduction to Simple Machines: Wheels, Axles & Inclined Planes 121 Pieces

Age 8+, builds 7 models, supports 2-3 students.



- 221 pieces to make 7 real world examples of how a wheel turns an axle, how an axle turns a wheel, plus two levels of inclined planes and a screw and wedge.
- The set supports a team of 2 to 3 pupils.
- Build 7 models, one at a time.
- Includes Teacher's Guide with 6 lesson plans

CODE	Description	Unit	1+
KNX862WHL	Wheels	1	34.95

### K'Nex Education STEM Explorations Pulleys 139 Pieces

Age 8+, builds 3 models, supports 2-3 students.



- Low priced introductory sets allows children to explore the concepts associated with different lever classes and pulleys.
- Builds three different models: Balance, Wheelbarrow and a Sailboat.
- Includes 3 experiment worksheets, one for each model.

CODE	Description	Unit	1+
KNX931PUL	Pulleys	1	13.25

### K'Nex Education STEM Explorations Roller Coaster 546 Pieces

Age 8+, 3 models, 2-3 students.



- Designed to engage and inspire pupils as they further their knowledge and understanding of how science, technology, engineering and maths concepts are used in the development of thrill rides.
- Includes 3 experiment worksheets, one for each model.

CODE	Description	Unit	1+
KNX932RLC	Roller Coaster	1	22.25

### K'Nex Education STEM Explorations Swing Ride 486 Pieces

Age 8+, 3 models, 2-3 students.



- An engaging project which will further students knowledge and understanding of the science, technology, engineering and maths concepts associated with this popular amusement park ride.
- Build a working swing ride with this educational building set.

CODE	Description	Unit	1+
KNX777SWR	Swing Ride	1	34.95

### K'Nex Education STEM Explorations Vehicles

Age 8+, builds up to 7 models, supports 2-3 students.



- Introduces individuals and small groups of children to important engineering concepts in a fun and highly accessible way.
- Build up to seven vehicle models with different power sources, such as push power, rubber band power, wind power, and a spring motor.
- Includes 7 experiment worksheets - one for each model.

CODE	Description	Unit	1+
KNX707VEH	Vehicles	1	34.95

### K'Nex Education STEM Explorations Gears 140 Pieces

Age 7+, builds 3 models, supports 2-3 students.



- Low priced introductory sets allows children to explore the concepts associated with gears.
- Builds three different models: Crank Shaft, Egg Beater and Car Window Model.
- Includes 3 experiment worksheets, one for each model.

CODE	Description	Unit	1+
KNX318GEA	Gears	1	13.25

## Kid K'NEX Budding Builders Tub 100 Pieces

Aged 3+



- Make learning more fun and exciting with the Budding Builders Building Set..
- Contains 100 pieces and can make 50 different builds.
- Teach the basic concepts of building with a toy set that lets children learn while playing!

CODE	Description	Unit	1+
KNX561BBS	Builders	1	<b>30.50</b>

## Kid K'NEX Education Classroom Collection 225 Pieces

Aged 3+



- Stimulate preschool children's creativity with this large Education Classroom Collection.
- Build with the set's 225 parts including KID K'NEX rods, connectors and blocks.
- Featuring bright colours and made with premium-quality construction.

CODE	Description	Unit	1+
KNX869CLS	Classroom	1	<b>82.95</b>

## Kid K'NEX Education Group Set 131 Pieces

Aged 3+



- Make learning fun and exciting with this Group Set.
- This toy set allows 4 to 6 children to build 8 different animal creatures at once.
- It contains 131 big, soft and chunky pieces that can be mixed and matched into real creations.

CODE	Description	Unit	1+
KNX875GRP	Group	1	<b>49.50</b>

## K'NEX Building Set Amusement Park Building Set 3 in 1 744 Pieces

Ages 9+



- A classroom set that supports students in the learning processes and investigations into speed, distance and time.
- Set enables students to create 3 different models, one at a time - create a majestic Ferris wheel that stands almost 3 feet tall, a heart-pounding boom ride, or an exciting swing ride.
- Contains 744 classic parts & pieces, including rods and connectors and a battery-powered motor that gives life to each model.

CODE	Description	Unit	1+
KNX703APK	Amusement Park	1	<b>57.95</b>

## K'NEX Building Set Creation Zone 50 Model Building Set 417+ Pieces

Age 5+



- Promotes the development of STEAM (science, technology, engineering, arts, and math) concepts by igniting students' natural curiosity and creativity.
- Contains over 417 brightly coloured classic rods and connectors that click together in a multitude of 3D configurations.
- Instructions for 50 models included.

CODE	Description	Unit	1+
KNX651CZM	Creation Zone 50	1	<b>28.95</b>

## K'NEX Education Maker Kit Large 800 Pieces

Age 6+, 100 model ideas, 12 students



- 100 unique building ideas are included to understand how structures are made, and how to change and improve the design of models.
- Help students develop a better understanding of STEAM (science, technology, engineering, arts, and math subjects) with this building set.
- Allows up to 12 children to work together at once.
- Includes 64 page building guide booklet and a useful reusable storage case with section dividers to hold the 800 pieces.

CODE	Description	Unit	1+
KNX849MKL	Large	1	<b>74.50</b>

## K'NEX Building Set Power & Play 50 Model Motorised Building Set 529 Pieces

Age 7+



- Easy-to-follow instructions that will teach students to create an endless array of models, from a chopper race car, or carousel to a rocket, a spaceship, or even a game of basketball.
- Contains 529 parts, including different types of connectors, rods, and wheels and a battery powered motor, these parts can be joined in endless configurations.
- Instructions for 50 models included.

CODE	Description	Unit	1+
KNX301PPM	Power & Play 50	1	<b>49.50</b>

## Electronics 6 in 1 Solar Kit



- Self-assembly kit providing an ideal introduction to how solar energy works.
- Enables 6 different solar powered models to be built (Windmill, revolving plane, airboat, desktop plane, robotic dog and car).
- The models require bright sunlight or a halogen or incandescent light source. Will not operate in cloudy or shaded locations, or under fluorescent light.
- A comprehensive instruction manual provides clear step by step instructions for building each model.

CODE	Description	Unit	5+	1+
KIT601SLC	6 in 1 Solar Kit	1	<b>18.50</b>	19.75

## Electronics Solar Charger Panel 3V Output



- Fully encapsulated assembly incorporating 8 individual cells and producing an output of 3V, 100 mA maximum.
- Can be used as a power source for low current equipment or for trickle charging AAA or AA size rechargeable batteries, mobile phones, MP3 players etc.
- Fitted with a hinged mounting bracket, output is via a 1.8 m cable, terminated with red and black crocodile clips and 1.3 mm DC power plug.

CODE	Output	Size	Unit	5+	1+
ECM130SCH	100mA/3.0V	95 x 65 x 7.5mm	1	<b>11.75</b>	12.75

### TechCard Build-it Kit 30 Models



- The TechCard Build-it Kit explores strong structures through a set of models incorporating linkages, levers and winders.
- Explore strong shapes and structures through a set of working models incorporating linkages, levers and winders. Investigate why things are the shape they are and how different materials are useful for different tasks.
- Explore how materials are shaped to make them more useful and learn how to build strong structures.
- The kit also includes teacher's notes, discovery pack with additional models and individual assembly instructions with a 'Follow the Force' section for each model.
- The TechCard 10 models include: Lever Hoist, Mechanical Puppet, Snapping Snake, Flapping Bat, Tower Crane, Draw Bridge, Marble Run, Balance Scales, Lever Crane and Triangulated Bridge.
- Contains 3 each of the 10 core models.
- Suits 5 - 12 Years.

CODE	Description	Unit	1+
TCD302BDK	Build-it 30	1	<b>41.50</b>

### TechCard Move-it Kit 30 Models



- The TechCard Move-it Kit explores how simple mechanisms such as wheels, axles, pulleys, cams and cranks are used to transmit and alter the forces applied to them.
- Explore a wide range of important simple mechanisms and discover how they can be used to transmit and alter the power and direction of a force.
- The kit includes teacher's notes, discovery pack with additional models and individual assembly instructions. Also a 'Follow the Force' section for each model where students are asked to map and explain the change of direction and the power of the forces applied.
- The TechCard 10 models include: Mechanical Hammer, Crank Powered Merry-Go-Round, Spinning Spiral Toy, Pull-Cord Fairground Ride, Snapping Crab, Somersaulting Acrobat, Rubber Band Powered Dragster, Pull-Cord up & over Fairground Ride, Cam Powered Boat, and Mars Rover with Rotating Antennae.
- Contains 3 each of the 10 models.
- Suits 5 - 12 Years

CODE	Description	Unit	1+
TCD304MVT	Move-it 30	1	<b>45.95</b>

### TechCard Power-it Kit 30 Models



- The TechCard Power-it Kit explores how forces can be controlled to carry out useful work through a series of air powered models. Pupils discover that air, though invisible, is a substance that takes up space and can be used to transmit force.
- Understand and control forces through an exciting set of air powered models. Explore how forces can be controlled to carry out useful work.
- The TechCard kit includes teacher's notes, discovery pack with additional models and individual assembly instructions with a 'Follow the Force' section for each model.
- The TechCard10 core models include: Windmill, Air Turbine Car, Scissor Lift, Pneumatic Hoist, Pneumatic Tipper Truck, Air Turbine, Land Yacht, Air Powered Fairground Ride, Pneumatic Robot Arm and Balloon Powered Racer.
- Contains 3 each of the 10 core models.
- Suits 5 - 12 Years.

CODE	Description	Unit	1+
TCD306PWK	Power-it 30	1	<b>46.25</b>

### TechCard Single Model Kits



- Popular models drawn from the large multi model kits.
- The single kits are ideal to multi buy to explore specific topics.

CODE	Description	Unit	2+	1+
TCD071DBK	Draw Bridge	1	<b>3.25</b>	3.95
TCD081SSK	Snapping Snake	1	<b>3.25</b>	3.95
TCD121DGK	Dragster	1	<b>3.25</b>	3.95
TCD101MGK	Merry-Go-Round	1	<b>3.95</b>	4.95

### TechCard Maker Pack 30 Models



- The Maker Pack includes TechCard parts to make 30 moving models when used with a range of upcycled boxes and other materials.
- The TechCard parts include structural elements, wheels, axles, cams and linkages.
- Three sets of instructions let the teacher choose between the popular topics of Moving Machines, Moving Monsters and Moving Toys.

CODE	Description	Unit	1+
TCD036MPK	Maker Pack	Pack	<b>32.25</b>

### TechCard Formula T Car 10 Models



- Builds ten exciting motorised racing cars!
- All materials, components and full instructions are included. Make, modify and race these racers for an exciting lesson while investigating key topics in the curriculum. Simple to set up pulley drive system.
- Ideal for STEM and STEAM workshops!

CODE	Description	Unit	1+
TCD034BPK	Balloon Dragster	Pack of 10	<b>43.75</b>

### TechCard Simple Vehicles 10 Models



- Builds ten motorised simple vehicles to modify, test and race!
- All materials and full instructions included.
- The simple pulley drive is easy to set up to change the size, speed and direction of a force.
- Investigate key topics in the science, design & technology and maths curriculums.

CODE	Description	Unit	OFFER
TCD030VPK	Simple Vehicles	Pack of 10	<b>37.25</b>

Meters

## Electronic Projects Uni-T Handheld Infrared Thermometer



- An infrared thermometer that determines temperature of objects through their emitted radiation.
- Main function is to measure temperature from a distance -18 to 280 degrees C.
- Digital display measures in both oC to cF.
- Requires a 9V battery

CODE	Description	Unit	1+
UNT300THR	Thermometer	1	<b>23.25</b>

## Electronic Projects Uni-T Mini Sound Level Meter Bluetooth Option



- Converts ambient sound into electrical signals, process data and displays results on LCD.
- Can constantly monitor ambient sound.
- Light weight, compact, ergonomic, and user friendly.
- The Bluetooth version uses Bluetooth to transfer data and analyse, store, export through UNI-T's custom mobile APP (iENV). iENV can be downloaded free.
- Requires 3 x AAA batteries.

CODE	Description	Unit	1+
UNT353SLM	Sound Meter	1	<b>22.50</b>
UNT355SLB	With bluetooth	1	<b>31.95</b>

## Electronic Projects Uni-T Mini Temperature and Humidity Meter Bluetooth Option



- High-precision temperature humidity sensing module technology to sample, processes data, and displays results on the LCD.
- Uses a calibrated sensing module which reduces bias and increases accuracy.
- Light weight, compact, ergonomic, and user friendly.
- The Bluetooth version uses Bluetooth to transfer data and analyse, store, export through UNI-T's custom mobile APP (iENV). iENV can be downloaded free.
- Requires 3 x AAA batteries.

CODE	Description	Unit	1+
UNT333THM	Temperature/Humidity	1	<b>21.95</b>
UNT335THB	With Bluetooth	1	<b>32.25</b>

## Electronic Projects Uni-T Mini Anemometer Bluetooth Option



- Mini wind speed and wind temperature tester.
- Equipped with the latest magnetic sensing technology which can directly display the air flow speed on the LCD display.
- Light weight, compact, ergonomic, and user friendly.
- The Bluetooth version uses Bluetooth to transfer data and analyse, store, export through UNI-T's custom mobile APP (iENV). iENV can be downloaded free.
- Requires 3 x AAA batteries.

CODE	Description	Unit	1+
UNT363ANM	Anemometer	1	<b>21.25</b>
UNT365ANB	With Bluetooth	1	<b>28.95</b>

## Electronic Projects Uni-T Mini Light Meter Bluetooth Option



- Photoelectric sensing technology, which can effectively represent light intensity with electrical signals, then processes data and displays the result on LCD.
- Range 0 - 199,999 Lux.
- Light weight, compact, ergonomic, and user friendly.
- The Bluetooth version uses Bluetooth to transfer data and analyse, store, export through UNI-T's custom mobile APP (iENV). iENV can be downloaded free.
- Requires 3 x AAA batteries.

CODE	Description	Unit	1+
UNT383LMT	Light Meter	1	<b>22.50</b>
UNT385LMB	With Bluetooth	1	<b>30.95</b>

## Electronic Projects Uni-T 3A/32V DC Power Supply



- A 3A, 32V single-channel linear DC power supply.
- Low ripple/noise, overload protection and constant voltage/current features.
- Display with easy reading for simultaneous presentation of voltage and current output.
- High precision voltage and current adjustments.

CODE	Description	Unit	1+
UNT130PWS	Power Supply	1	<b>86.75</b>



### Prototyping Board



- White high durability polyacetal (POM) board mounted on adhesive foam base.
- Contact positions clearly indicated by screen printedphanumeric grids and colour coded polarity indicators.
- Interlocking facility enables two or more boards to be fixed together.
- Total 400 tie points. 1 terminal strip (300 tie points) 2 distribution strips (100 tie points).

80 x 54 x 10mm

CODE	Description	Unit	5+	1+
ECM400PTB	Prototyping Board	1	7.25	7.95

### Jumper Wire Kits 140 Piece



- Suitable for use with Prototype Boards (Breadboard)
- Contains 10 pieces each of 14 different lengths 0.1" to 5", total 140 pieces.
- Wires are PVC insulated 22AWG (1/0.5mm), colour coded in a variety of different colours.
- Preformed ready for use by being bent 90° at each end and stripped approx 6mm.
- Contained in handy Perspex partitioned case.

CODE	Description	Unit	5+	1+
ECM140JWK	Jumper Wire Kit	Pack 140 Pieces	6.95	7.50

### Stripboard



- Low cost stripboard, manufactured from copper clad laminated board.
- Punched on a 0.1" pitch with 1mm diameter holes.
- 3360 holes (35 strips x 96 holes).

100 x 250mm

CODE	Description	Unit	5+	1+
ECM250STB	Stripboard	1	3.60	3.90

### Connecting Wire 100m



- UK manufactured solid core connecting wire to DEF61-12.
- Part 6 Type 2 and BS4808 part 2 standard.
- 100m reel, 1.2 mm nominal O/D, rating 1.8 A @ 1,000V RMS max.
- Core: 0.6 mm tinned copper conductor.
- Sheath: PVC 0.3 mm to DEF61-12 Type 2.

CODE	Description	Unit	5+	1+
ECM112WRD	Red 100m	1 Reel	11.25	12.25
ECM112WBK	Black 100m	1 Reel	11.25	12.25

### Standard Crocodile Clips Pack of 100



- Nickel-plated steel (50mm length), with a 4 mm socket at rear.
- Screw or solder connection.

CODE	Description	Unit	5+	1+
ECM100CRC	Crocodile Clips	Pack of 100	11.25	12.25

### Crocodile Leads Set of 10



- A set of 10 leads (2 each of red, black, green, yellow and white), with plastic insulated miniature crocodile clips at each end.
- Lead length 50cm. Maximum current 0.5A.

CODE	Description	Unit	5+	1+
ECM010CLP	Crocodile Leads	Set of 10	2.25	2.50

### Stackable Test Leads 4mm Pack of 5



- Test leads with 4mm (banana) plugs at each end, available in 5 colours and in 3 different lengths.
- Stackable with a cage spring to provide secure connection, and incorporate a socket at the rear.
- Body and spring are nickel plated machined brass, insulated ABS covers.
- Voltage: 30VAC – 60VDC, max. current: 15A.

CODE	Colour	Size	Unit	5+	1+
ECM500LRD	Red	500mm	Pack of 5	6.25	6.75
ECM500LBK	Black	500mm	Pack of 5	6.25	6.75
ECM500LGR	Green	500mm	Pack of 5	6.25	6.75
ECM500LYL	Yellow	500mm	Pack of 5	6.25	6.75
ECM500LBU	Blue	500mm	Pack of 5	6.25	6.75

### Miniature 2" Speakers Pack of 10



- Super-slim speakers have paper cones and ferrite magnets.
- Solder connection tags and supplied individually boxed.

CODE	Description	Unit	5+	1+
ECM200SPK	2" Speaker	Pack of 10	7.25	8.25

### Miniature Electronic Buzzers Pack of 10

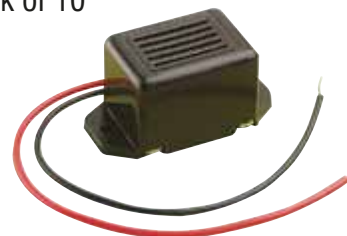

- Low cost miniature transistor oscillator 3V or 6V buzzers with flying leads.
- Frequency: 400Hz, Sound Output: 75dB @ 30cm, Current: 30mA.
- Fixing Centres: 27.5mm. Lead Length: 100mm.
- For optimum performance, please ensure the correct configuration of batteries/voltage is used.

L23 x W17 x H15mm

CODE	Voltage	Unit	5+	1+
ECM310BUZ	3V	Pack of 10	8.95	9.50
ECM610BUZ	6V	Pack of 10	8.95	9.50

## Tyred Wheel

To suit ECM120MGB



- Designed for the Inline Motor Gearbox.
- 70mm diameter x 25mm wide wheel with soft rubber tyre.

CODE	Description	Unit	5+	1+
WHL070TYR	Tyred Wheel	1	2.00	2.25

## Inline Motor and Gearbox



- Inline motor with gearbox providing 120:1 gear ratio.
- Operating range 3.0-6.0V
- Speed at nominal 4.5V: 90RPM no load / 72RPM at load.
- Torque at nominal 4.5V: 03Kg/cm.
- Stall torque: 1.4Kg/cm.

64.2 x 22.5 x 18.8mm

CODE	Description	Unit	5+	1+
ECM120MGB	Inline Motor Gearbox	1	2.50	3.00

## Gearbox and Motor

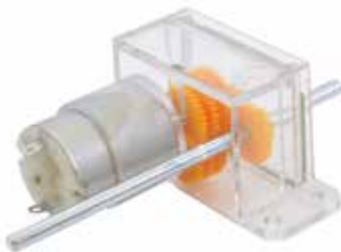

- Combined motor and gearbox unit especially designed for educational use.
- Motor operates between 1.5 and 6V DC.
- Includes interchangeable gears, giving a range of speeds and motor torques.
- Clear polycarbonate housing provides mounting for both the motor and gears.
- Full instructions for calculating gear ratios etc. are included. Shaft 4mm diameter.

CODE	Description	Unit	5+	1+
ECM156MGB	Gearbox and Motor	1	10.50	11.25

## Universal Mounting Clip

Pack of 10



- A universal plastic bracket which fits all three types of electric motor and has a self-adhesive pad on the base.

CODE	Description	Unit	5+	1+
ECM010SMM	Mounting Clip	Pack of 10	4.95	5.95

## Miniature Vibration Motor



- Miniature vibration motor measuring only 12mm long x 6mm diameter.
- Coreless motor design, rated at 3V nominal, current: 75mA and weight: 1.85g.
- Originally designed for silent alert functions in mobile phones, but can be used effectively to motorise models by a vibration/shuffle action.
- Pre-wired with red and black leads 90mm.
- Rated speed: 14000 RPM ( $\pm 2000$  RPM).

CODE	Description	Unit	5+	1+
ECM126VBR	Mini Vibration Motor	1	2.00	2.25

## Motor, Gearbox and Shaft Unit



- This complete unit consists of a motor and output shaft that click into place in black plastic casing which utilises a worm-drive.
- Shaft diameter 3mm.
- New gearbox design which has increased rigidity and does not require any additional strapping.
- Powered from 3 - 6V.

CODE	Description	Unit	5+	1+
ECM306MGB	Complete Unit	1	3.80	4.10

## Low Torque Flat DC Motor

Pack of 10



- Miniature DC motor with an operating range of 1.5 to 4.5V (nominal 3V).
- Two flat sides enable easy mounting onto a panel or PCB.
- Rotation is counter-clockwise (viewed from shaft end), no load speed: 16000 RPM.
- Dimensions: L: 25 (exc. shaft) W: 20.1 H: 15.1mm Shaft length 8.1x 2.0mm diameter, weight 19g.

CODE	Description	Unit	5+	1+
ECM145MNM	Flat DC Motor	Pack of 10	4.50	4.75

## Medium Torque Round DC Motor

Pack of 10



- Medium torque miniature DC motor with an operating range of 1.5 to 4.5V (nominal 3V).
- Rotation is clockwise as viewed from shaft end.
- No load speed: 6600 RPM.
- Dimensions: L: 27 (exc. shaft) x 24mm diameter, Shaft length 8.6 x 2.0mm diameter, weight 28g.

CODE	Description	Unit	5+	1+
ECM154MDM	Med. Torque Motor	Pack of 10	6.75	7.25

## High Torque Round DC Motor

Pack of 10



- High torque miniature DC motor with an operating range of 1.5 to 6.0V (nominal 3V).
- Rotation is clockwise as viewed from shaft end.
- No load speed: 9600 RPM.
- Dimensions: L: 30.5 (exc. shaft) x 24mm diameter, Shaft length 10x 2.0mm diameter, weight 42g.

CODE	Description	Unit	5+	1+
ECM156HTM	High Torque Motor	Pack of 10	7.75	9.00

### Miniature 2V Solar Motor



- Precision low inertia motor with very low starting current.
- Rotation is clockwise as viewed from shaft end.
- Nominal voltage: 2.0V, no load speed: 2300 RPM, no load current: 0.016A, torque: 5.4g-cm.

**12.8 x 24.3mm Diameter**  
**Shaft 6.0 x 2.0mm Diameter**

CODE	Description	Weight	Unit	5+	1+
ECM200MSM	Mini 2V Solar Motor	20g	1	<b>1.50</b>	1.75

### Electronics Polycrystalline Solar Cell Modules



- Grade 'A' high efficiency polycrystalline voltaic solar cells.
- Resin encapsulated, fitted with high-temperature silicon 200mm red and black connecting wires.
- Can be connected in series or parallel to obtain the desired voltage or output current.
- Class IP54 protection. CE approved.

CODE	Output	Size	Unit	5+	1+
ECM415SCP	400mA/1.5V	90x60x3mm	1	<b>4.90</b>	5.25
ECM420SCP	400mA/2.0V	120x62x3mm	1	<b>7.25</b>	7.75
ECM135SCP	130mA/5.0V	120x62x3mm	1	<b>8.75</b>	9.50

### Plastic Cams

Pack of 80



- Sets of cams comprising:- 2 pear shaped cams, 1 snail cam and 1 eccentric cam. Holes included for 3mm axle. Approx size.
- Available in red, green, yellow and blue.
- Pack contains 20 sprues with 4 cams on each.

CODE	Description	Unit	5+	1+
CAM800PAK	Plastic Cams	Pack of 80	<b>7.50</b>	8.95

### Plastic Gears

Pack of 80



- Sets of 4 large polythene gears. Tooth count 12, 20, 30 and 40). All 6mm thick.
- The small 15mm gear is a press fit onto our electric motors (2mm shaft), the others require a 3mm shaft.
- The large gear will clip to the end of a cotton reel, if required.
- Available in red, yellow, blue and green.
- Each pack contains 20 sprues with 4 gears on each.

**15mm, 22mm, 32mm and 40mm Diameters**

CODE	Description	Unit	5+	1+
GEA800PAK	Plastic Gears	Pack of 80	<b>10.75</b>	11.50

### Plastic Pulley

Set of 4



- An assorted pack of four plastic pulleys.
- The 10mm pulley is a push fit onto motor or 2mm axle, all others are a push fit onto 3.2mm diameter axle.
- The boss fits tightly into the 75mm wheel moulding to provide an integral pulley.

**10, 20, 30 and 40mm Diameters**

CODE	Description	Unit	5+	1+
PUL400ASS	Assorted Plastic Pulleys	Set of 4	<b>1.20</b>	1.30

### Push Fit Motor Pulley

Pack of 5 or 50



- Provides a small drive pulley - presses directly onto a motor spindle.
- 2mm bore diameter.

CODE	Description	Unit	4+	1+
PUL005PFT	Small Pulley	Pack of 5	<b>0.95</b>	1.10
PUL050PFT	Small Pulley	Pack of 50	<b>10.25</b>	10.95

### Offset-Centre Mass Wheel

Pack of 20



- These small mouldings fit directly onto 2mm motor spindles and provide the imbalance needed for 'bugs' and vibrating mechanisms.
- No more 'Blu tac' etc. to provide imbalance on ordinary wheels.

*Motor not included.*

CODE	Description	Unit	5+	1+
WHL200PAK	Offset-Centre Mass Wheel	Pack of 20	<b>5.95</b>	6.50

### Miniature Impeller

Pack of 10



- Plastic push-fit impeller, suitable for use with all miniature DC motors with a 2mm shaft.
- Diameter 60mm with 5 blades.

**60mm Diameter**

CODE	Description	Unit	5+	1+
ECM060IMP	Impeller 60mm	Pack of 10	<b>10.00</b>	10.75

### Miniature Propellers

Pack of 10



- Plastic 3 bladed propellers suitable for use with 2mm diameter motor shafts.
- 3 blade diameter 115mm approx.

CODE	Description	Unit	5+	1+
ECM115PRP	3 blade 115mm	Pack of 10	<b>8.25</b>	8.50

## Miniature Propellers

Pack of 10



- Plastic 2 bladed propeller suitable for use with 2mm diameter motor shafts.
- 2 blade version is available in either 90mm or 150mm diameter.

CODE	Description	Unit	5+	1+
ECM090PRP	2 blade 90mm	Pack of 10	<b>3.30</b>	3.60
ECM150PRP	2 blade 150mm	Pack of 10	<b>6.00</b>	6.25

## Round Balloons

Pack of 100



- Great value pack of 100 round balloons. 100% latex.
- Size: 175mm.

CODE	Description	Unit	4+	1+
BLL100PAK	Balloons	Pack of 100	<b>7.25</b>	7.95

## Magnetic Tape

Adhesive Backed



- Magnetic rubber tape with adhesive backing.
- Length 10m.

CODE	Description	Unit	4+	1+
MAG108TPE	8mm	1	<b>6.95</b>	7.75

## MagDots Adhesive Backed

Pack of 300



- Self-adhesive round magnetic dots and pads, ideal for art and DT projects.
- Simply stick to the desired surface making it instantly magnetic.

CODE	Description	Unit	4+	1+
MAG312DOT	Round 12mmø	Pack of 300	<b>7.50</b>	8.25

## Student Calculator



- Multi-function calculator with auto shut-off, 5 key memory and four functions.
- Dual power source: solar and battery (battery included).
- 8 digit LCD display.
- 112 x 68mm.

CODE	Description	Unit	12+	4+	1+
CAL135STU	Multi-function	1	<b>3.75</b>	3.95	4.25

## Pneumatics Syringe

Pack of 10



- For use in conjunction with 4mm PVC tubing.
- Rubber seal gives an effective push-pull action.
- Available in 3 capacities

CODE	Description	Unit	4+	1+
SYR005PAK	5ml	Pack of 10	<b>5.50</b>	6.25
SYR010PAK	10ml	Pack of 10	<b>5.50</b>	6.25
SYR020PAK	20ml	Pack of 10	<b>7.75</b>	8.50

## PVC Tubing



- PVC tubing in clear and colours which denote the bore size.
- Use for pneumatics (4mm), shaft/axle caps, spacers on axles etc.
- 30m reel.

CODE	Description	Unit	2+	1+
TBE330PVC	Clear 3mm x 30m	1	<b>8.50</b>	9.00
TBE410PVC	Clear 4mm x 10m	1	<b>4.50</b>	4.95
TBE430PVC	Clear 4mm x 30m	1	<b>15.25</b>	16.75
TBE530PVC	Yellow 5mm x 30m	1	<b>16.95</b>	18.50
TBE630PVC	Red 6mm x 30m	1	<b>21.95</b>	23.95

## Pneumatics Tubing Connectors

Pack of 20 or 100



- Connectors to join the 4mm PVC clear plastic tubing for pneumatics.

CODE	Description	Unit	1+
PNE220STC	2 Way	Pack of 20	<b>4.95</b>
PNE320TWC	3 Way	Pack of 20	<b>4.95</b>
PNE420FWC	4 Way	Pack of 20	<b>4.95</b>
PNE300TWC	3 Way	Pack of 100	<b>22.00</b>
PNE400FWC	4 Way	Pack of 100	<b>22.00</b>
PNE200STC	2 Way	Pack of 100	<b>22.00</b>

## Pneumatics Bulk Pack



- A pack containing the items needed for pneumatics based activities.
- Includes: 100 x each of 2 way, 3 way and 4 way connectors, 100 x 5ml, 100 x 10ml and 50 x 20ml plastic syringes, 9 x 10metres rolls of 4mm plastic tubing.

CODE	Description	Unit	1+
PNE300CTR	Bulk	1	<b>202.00</b>

### Plastic Cotton Reels

Pack of 100



- Plastic cotton reels in five colours - (20 of each colour)
- Useful in model making, also as a wheel hub.
- Overall length 31mm; max diameter 32mm.

CODE	Description	Unit	4+	1+
REL100PLS	Cotton Reels	Pack of 100	10.95	11.95

### Plastic Axle Bracket

Pack of 100



- Designed to accept a maximum shaft diameter of 5mm.
- Can be held to the chassis with sticky pads or screwed via 3mm fixing holes.

CODE	Description	Unit	4+	1+
AXB105PLS	Axle Brackets	1	10.75	11.75

### Large Polythene Wheels

Pack of 20



- Large 75mm yellow plastic wheels and can be used in conjunction with other components.
- Note that the boss of the pulley set fits tightly into the wheel moulding to give an integral pulley/wheel system.
- Approx. 10mm thick with a hole for a 3mm axle.

#### 75mm Diameter

CODE	Colour	Unit	5+	1+
WHL750YEL	Yellow	Pack of 20	12.50	13.50

### Tyre Material for Cotton Reels 2m

Pack of 4



- Use short lengths to create chunky tyres for your cotton reel wheels.
- Soft nitrile foamed rubber.
- Enough material to produce 60 tyres.
- Bore 28mm x 9mm wall thickness
- Pack of 4x 500mm lengths

CODE	Description	Unit	4+	1+
TYR602SNF	Tyre Material	Pack of 4	4.50	5.55

### CD Wheel Adaptors

Pack of 20



- These special 39mm polythene wheels have a moulded rim that fits snugly into the centre hole of a CD.
- Enables CDs to be used as wheels, turntables, etc.
- Will press-fit onto a 3mm diameter shaft.

#### 39mm

CODE	Description	Unit	5+	1+
WHL390CDA	CD Wheel Adaptors	Pack of 20	4.10	4.40

### Standard Polythene Wheels

Pack of 100



- Popular 39mm plastic wheels and can be used in conjunction with other components.
- Supplied in a pack of 100.
- Available in blue, red, yellow or green.
- Will press-fit onto a 3mm diameter shaft.

#### 39mm Diameter

CODE	Colour	Unit	5+	1+
WHL390BLU	Blue	Pack of 100	23.95	25.95
WHL390RED	Red	Pack of 100	23.95	25.95
WHL390YEL	Yellow	Pack of 100	23.95	25.95
WHL390GRN	Green	Pack of 100	23.95	25.95

### Foam Washers

Pack of 100



- Foam washers to secure wheels, gears, pulleys or cams to their axles.
- Fits axles 4-6mm diameter.

CODE	Description	Unit	4+	1+
FAM406WSH	Foam Washers	1	3.95	4.50

### Axle Material 3mm

Pack of 10 or 50



- Steel Rod for axles and shafts in 300mm lengths
- To suit components with a 3mm hole.

#### 300mm Length

CODE	Description	Unit	1+
AXL310STL	Steel Axle Material	Pack of 10	5.95
AXL350STL	3mm Axle Material	Pack of 50	23.75

### Caterpillar Track



- A soft durable track with a transverse tread.
- Ideal to be used with our 39mm coloured wheel or 75mm yellow wheel.
- Approximately 180mm long when used with the 39mm wheels.

#### 188mm Length 30mm Width

CODE	Colour	Unit	5+	1+
TRK030BLK	Grey	1	1.60	1.75

## Eduk8Systems Torch Project Kit White



- Simple but effective torch kit to get students introduced to electronics and soldering.
- Many body designs and materials can be utilised.
- Includes 2 x AAA batteries.
- Contents: 2 x AAA Size Holder, 2 x AAA Batteries, 1 x Bright White 5mm Clear LED, 1 x Resistor, 1 x PCB Mount Slide Switch.
- PCB dimensions length: 65mm x width: 25mm.
- Supplied as a kit.

CODE	Colour	Unit	50+	5+	1+
EDU250KIT	Torch Kit	1	1.75	2.25	2.75

## Eduk8Systems USB Lamp Kit Colour Changing



- Table lamp kit powered by a computer or any USB port.
- Features a colour changing LED which cycles through red, green, yellow and then in combination.
- Slide switch on the board.
- 1 x USB Power Cable, 1 x PCB Mount Slide Switch, 1 x Colour Changing (Rainbow) LED, 1 x Resistor, 1 x PCB.
- PCB dimensions length 40mm x width 20mm.
- Supplied as a kit.

CODE	Colour	Unit	50+	5+	1+
EDU310KIT	Colour Changing	1	1.50	2.00	2.75

## Eduk8Systems USB Lamp Kit White



- Table lamp kit powered by a computer or any USB port.
- Features a white LED for bright illumination.
- Slide switch on the board.
- 1 x USB Power Cable, 1 x PCB Mount Slide Switch, 1 x White LED, 1 x Resistor, 1 x PCB.
- PCB dimensions length 40mm x width 20mm.
- Supplied as a kit.

CODE	Colour	Unit	50+	5+	1+
EDU320KIT	White	1	1.50	2.00	2.75

## USB Power Lead



- Ideal to provide power for basic electronic projects, from a PCB or similar device.
- Also suitable for a 5V, 500mA power supply.
- With pre-tinned wires.

Length 600mm

CODE	Length	Unit	50+	10+	1+
ECM600USB	600mm	1	0.50	0.55	0.75

## Resistors Assorted Pack of 4000



- CR25 high stability carbon film resistors.
- Wattage: 0.25W, maximum working voltage: 300V.
- RoHS compliant and meets or exceeds EIA-RS-196A, JIS-C-6402 & IEC-115.
- Pack of 4000 - 100 of 40 different values ranging from 0R to 10M.
- Body 6.5mm dia. x 2.5mm and legs 28mm long x 0.6mm.

CODE	Colour	Unit	1+
ECM004RPK	Assorted	Pack of 4000	59.50

## Rectifier Diode 1A Pack of 10



- Standard recovery 1N4006 series 1A rectifier diode.
- Low forward voltage drop and low reverse leakage current
- High surge current rating and can be mounted in any position.
- Max recurrent peak reverse voltage VRRM 800V, max RMS voltage VRMS 560V, max DC blocking voltage VDC 800V.

CODE	Colour	Unit	5+	1+
ECM406RDD	Rectifier Diode	Pack of 10	0.20	0.40

## Signal Diode Pack of 10



- General purpose low signal switching diode.
- Max repetitive reverse voltage 100 V IF(AV) average rectified forward current 200 mA.
- RoHS compliant.

CODE	Colour	Unit	5+	1+
ECM148SDD	Signal Diode	Pack of 10	0.15	0.30

## Single Timer IC



- Timing from microseconds to hours producing accurate time delays or oscillation.
- Frequency and duty cycle can be controlled independently with two external resistors and a single external capacitor.
- Operation is specified for supplies of 5 V to 15 V.
- Compliant to MIL-PRF-38535

CODE	Colour	Unit	5+	1+
ECM555TMR	Single Timer	1	0.25	0.50

## Light Dependent Resistor Pack of 5

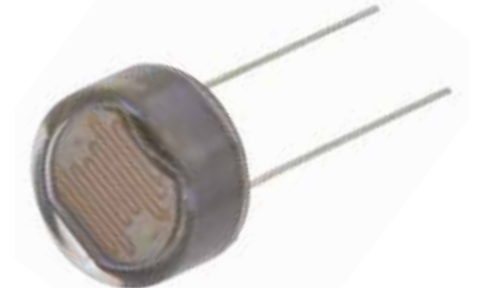

- Photoconductive cadmium sulphide light dependent resistor housed in a sealed 13mm epoxy case with clear lens window.
- Resistance decreases as light falling on the window increases.
- Peak wavelength: 560nm, maximum voltage: 320V.
- On resistance: 6.5Kohm - 13.5Kohm and off resistance: 0.5Mohm.

CODE	Description	Unit	5+	1+
ECM013LDR	LDR	Pack of 5	10.25	12.50

**Eduk8Systems Electronics Kits**  
**Light With Switch**  
 Class Pack of 30 Sets



- Simple circuit lights up the LED when the switch is pressed.
- Supplied with leads which terminate with battery studs.
- Designed to be powered by a 9 volt battery (not supplied).

CODE	Description	Unit	2+	1+
EDU013KIT	Light/Switch	Pack of 30	33.50	36.25

**Eduk8Systems Electronics Kits**  
**Energy Storage Circuit**  
 Class Pack of 30 Sets



- This circuit contains a large capacitor that can be charged by a solar panel, generator or battery.
- When the switch is pressed the energy is released from the capacitor to light up the LED.
- Supplied with leads which terminate with battery studs.
- Designed to be powered by a 9 volt battery (not supplied).

CODE	Description	Unit	2+	1+
EDU043KIT	Energy Storage	Pack of 30	38.75	41.95

**Eduk8Systems Electronics Kits**  
**Light Sensor with Led Output**  
 Class Pack of 10 Sets



- LED will illuminate in low-light conditions.
- Adjustable resistor can be set to match supply.
- Requires a 3V to 9V power source (not supplied).

CODE	Description	Unit	2+	1+
EDU331KIT	Light Sensor	Pack of 10	9.75	9.95

**Eduk8Systems Electronics Kits**  
**Latching Circuit**  
 Class Pack of 30 Sets



- This typical alarm circuit may be configured in different ways with different sensors or outputs for a range of alarm applications.
- When light falls on the sensor in this circuit the LED turns on and stays on until the reset switch is pressed.
- Supplied with leads which terminate with battery studs.
- Designed to be powered by a 9 volt battery (not supplied).

CODE	Description	Unit	2+	1+
EDU023KIT	Latching Circuit	Pack of 30	46.50	50.25

**Eduk8Systems Electronics Kits**  
**Transistor Switch/Amplifier Circuit**  
 Class Pack of 30 Sets



- This transistor circuit includes a light sensor. It can be configured so that the LED lights up in darkness or in bright light.
- The light sensor could be swapped for a temperature/moisture sensor and the LED could be replaced with a buzzer or small motor.
- Supplied with leads which terminate with battery studs.
- Designed to be powered by a 9 volt battery (not supplied).

CODE	Description	Unit	2+	1+
EDU053KIT	Transistor/Amplifier	Pack of 30	38.75	41.95

**Eduk8Systems Electronics Kits**  
**Temperature Sensor with Led Output**  
 Class Pack of 10 Sets

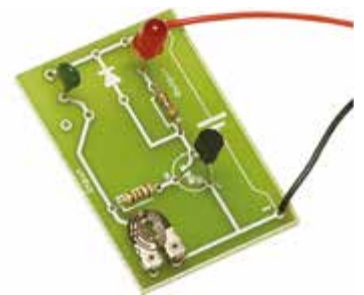

- LED will illuminate at about body temperature (adjustable by setting the small potentiometer on the board).
- Adjustable resistor can be set to match supply.
- Requires a 3V to 9V power source (not supplied).

CODE	Description	Unit	2+	1+
EDU341KIT	Temperature Sensor	Pack of 10	9.75	9.95

**Eduk8Systems Electronics Kits**  
**LED Light with Sensor**  
 Class Pack of 30 Sets

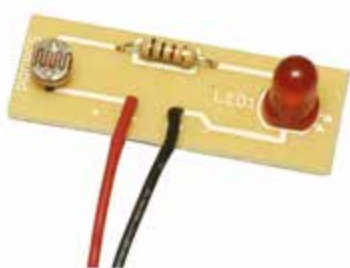

- This circuit includes a light sensor. The more light falling on the sensor, the brighter the LED will shine.
- Supplied with leads which terminate with battery studs.
- Designed to be powered by a 9 volt battery (not supplied).

CODE	Description	Unit	2+	1+
EDU033KIT	LED Light/Sensor	Pack of 30	25.75	27.95

**Eduk8Systems Electronics Kits**  
**Trial Pack of 5**



- A trial pack of the five small self-assembly circuits - Light With Switch, Latching Circuit, LED Light With Sensor, Energy Storage Circuit and Transistor Switch/Amplifier Circuit.
- Covers basic principles of electronics and can be adapted for numerous practical applications.
- Supplied with leads which terminate with battery studs.
- Designed to be powered by a 9 volt battery (not supplied).

CODE	Description	Unit	2+	1+
EDU155KIT	Trial Pack	Pack of 5	16.75	18.25

**Eduk8Systems Electronics Kits**  
**Humidity Sensor with Led Output**  
 Class Pack of 10 Sets



- LED will illuminate as humidity increases – e.g. by breathing on the sensor or holding the sensor over hot water.
- Adjustable resistor can be set to match supply.
- Requires a 6V to 9V power source (not supplied).

CODE	Description	Unit	2+	1+
EDU351KIT	Humidity Sensor	Pack of 10	15.95	19.95

## Crumble Official Starter Kit



- An easy-to-use programmable controller - drives 2 motors forwards and backwards at variable speeds.
- 4 x IO (Input/Output) pads which allow connections to switches, LDRs, low power LEDs and so on.
- Pads allow terminal blocks to be fitted or a direct solder connection made, while the larger 4mm holes make an easy target for conductive thread and needle.
- The Crumble software runs on PC, Mac and Linux (including the Raspberry Pi). Inspired by MIT Scratch, programs are simply built by snapping blocks together on screen. Sending a program to the Crumble is almost instant, allowing rapid experimentation.
- 1 x Crumble controller, 12 x Croc leads, 2 x Sparkles (controllable RGB LEDs), 1 x Crumble-friendly switch, 1 x Crumble-friendly light sensor, 1 x Crumble-friendly buzzer, 1 x Micro USB cable, 1 x Crumble-friendly switched battery box.

CODE	Description	Unit	1+
CRM301KIT	Starter Kit	1	21.95

## Crumble Controller



- A cheap, easy-to-use programmable controller.
- A few 'croc' leads and a USB cable are all you need to connect motors, LEDs and sensors and begin experimenting.
- Can drive 2 motors forwards and backwards at variable speeds.
- No programming experience is required as the FREE software is a graphical, drag-and-drop system.

CODE	Description	Unit	1+
CRM001UNT	Controller	1	9.95

## Crumble Giant Cut-Out



- A "cut-out" Crumble image (approx 400 x 250 x 4mm) - great for displays.
- Can be used to explain the Crumble layout and connections when teaching groups.

CODE	Description	Unit	1+
CRM400GNT	Cut-Out	1	7.95

## Crumble Micro USB Cable



- A quality lead to connect the Crumble to a computer.

CODE	Description	Unit	1+
CRM709USB	USB Cable	1	1.95

## Crumble Croc Lead Pack of 12



- Twelve short (240mm) crocodile leads (3 each of red, black, green and yellow) with plastic insulated 27.5mm crocodile clips at each end.
- Perfect for making Crumble connections!

CODE	Description	Unit	1+
CRM206CRL	Croc Leads	Pack of 12	2.50

## Crumble Switched Battery Box



- 3 AA switched battery box with croc-clip-friendly connection points and built-in resettable fuse to protect against short-circuits.
- The on-board green LED shows when the switch is on.
- A red LED will light when the fuse has been tripped (most likely due to a short circuit somewhere among the connections).

CODE	Description	Unit	1+
CRM202BBX	Battery Box	1	2.95

## Crumble Push Switch



- A push-to-make switch mounted on a PCB with croc-clip friendly connections.

CODE	Description	Unit	1+
CRM208SWT	Push Switch	1	0.95

## Crumble Reed Switch & Magnet



- Reed switch mounted on a PCB with croc-clip friendly connections.
- Includes a magnet.

CODE	Description	Unit	1+
CRM222RSM	Reed Switch	1	1.95

## Crumble Microswitch



- Microswitch mounted on a PCB with croc-clip friendly connections.

CODE	Description	Unit	1+
CRM221MSW	Microswitch	1	2.00

## Crumble Tilt Switch



- Tilt switch mounted on a PCB with croc-clip friendly connections.

CODE	Description	Unit	1+
CRM225TSW	Tilt Switch	1	2.00

## Crumble Toggle Switch



- Toggle switch mounted on a PCB with croc-clip friendly connections.

CODE	Description	Unit	1+
CRM224TGS	Toggle Switch	1	2.00



### Crumble Switch Pack



- This switch pack contains 5 switches mounted on PCBs with croc-clip friendly connections.
- Contains the following switches: Push, Micro, Reed, Toggle and Tilt.

CODE	Description	Unit	1+
CRM230SPK	Switch Pack	1	8.75

### Crumble Sparkles Strip of 5



- The colour of each LED Sparkle can be individually controlled by the Crumble.
- Each Sparkle has its own power in and out connections so can be chained together (up to 32 LEDs long).
- Supplied on a strip of 5, which need to be snapped apart.

CODE	Description	Unit	1+
CRM500SPK	Sparkles	Strip of 5	5.95

### Crumble Sparkle Baton



- A row of 8 full-colour LEDs ("Sparkles"), on one PCB, with croc-clip friendly connections at each end.
- The colour of each LED can be set individually by the Crumble.
- The "power-in" and "power-out" connections at each end mean the batons can be chained together (up to 4 batons controlled by 1 Crumble).

CODE	Description	Unit	1+
CRM211BAT	Baton	1	6.95

### Crumble Light Sensor



- Light Sensor (Phototransistor) mounted on a PCB with croc-clip friendly connections.

CODE	Description	Unit	1+
CRM217LSN	Light Sensor	1	1.50

### Crumble Buzzer



- Buzzer mounted on a PCB with croc-clip friendly connections.

CODE	Description	Unit	1+
CRM215BUZ	Buzzer	1	1.80

### Crumble Motors with Leads Pack of 2



- Two geared motors with croc-leads soldered on.
- Ready to connect to your Crumble.

CODE	Description	Unit	1+
CRM203MTR	Motors	Pack of 2	5.95

### Crumble Motor Clip



- Plastic clip with mounting holes for use with geared motors.

CODE	Description	Unit	1+
CRM003MTC	Motor Clip	1	0.50

### Crumble Chunky Wheels Pack of 2



- Pair of wheels that simply push-fit on to the axle of the geared motors.
- Chunky tyres.

CODE	Description	Unit	1+
CRM204WHL	Wheels	Pack of 2	2.40

### Crumble Line Follower Widget



- Line follower widget as used in the Crumble Robotic Vehicle.

CODE	Description	Unit	1+
CRM209LFW	Line Follower	1	4.95

### Crumble Micro Servo



- A custom crumbliser is included so you can connect the servo to a Crumble with croc-leads and get started straight away.
- The SG92R digital micro-servos is recommended for use with the Crumble, in tests it has less buzz and jitter.

CODE	Description	Unit	1+
CRM205SRV	Micro Servo	1	4.50

### Crumble Ultrasonic Distance Sensor



- Ultrasonic distance measuring sensor with a crumbliser soldered on so this module can be attached to the Crumble with croc leads.
- Requires two connections from A, B, C or D: one to trigger the ultrasonic pulse and one to measure the time for the echo to return.
- A single programming block reads the distance in cm.

CODE	Description	Unit	1+
CRM207UDS	Distance Sensor	1	2.95

## Miniature LDR Pack of 5

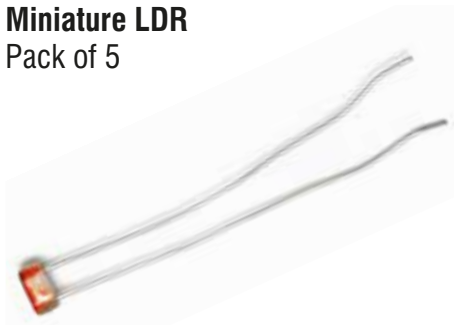

- Photoconductive cadmium sulphide light dependent resistor (LDR) in a miniature epoxy sealed open frame package (4mm diameter).
- Cell resistance reduces as light falling on the device increases.
- Peak spectral response: 540nm, maximum voltage: 100V.
- Light resistance: 50-100Kohm, dark resistance: 20Mohm min.

CODE	Description	Unit	5+	1+
ECM004LDR	Miniature LDR	Pack of 5	1.10	1.50

## Standard 5mm LEDs Pack of 100



- A selection of high quality 5mm diameter LED indicators with diffused coloured lens.
- Suitable for PCB or panel mount.

**5mm**

CODE	Colour	Unit	5+	1+
ECM501LDR	Red	Pack of 100	5.50	5.95
ECM502LDY	Yellow	Pack of 100	5.50	5.95
ECM503LDG	Green	Pack of 100	5.50	5.95

## Special 5mm LEDs Pack of 10



- High quality 5mm dia. LED's emitting either white or blue light
- Suitable for PCB or panel mount.

**5mm**

CODE	Colour	Unit	5+	1+
ECM514LDB	Blue	Pack of 10	1.75	1.95
ECM515LDW	White	Pack of 10	1.75	1.95

## 5mm Flashing LEDs Pack of 10



- High brightness flashing LEDs in standard 5 mm with clear lens.
- A built-in IC produces continuous flashing at a frequency of 1.8Hz.
- Operating voltage range 3.0 to 5.0V.

**5mm**

CODE	Colour	Unit	5+	1+
ECM591FLR	Red	Pack of 10	2.75	2.95
ECM592FLY	Yellow	Pack of 10	2.75	2.95
ECM593FLG	Green	Pack of 10	2.75	2.95

## 5mm Rainbow Cycling LEDs Pack of 10



- Colour changing 5mm clear lens LEDs with inbuilt chip which causes the LED to cycle through red, green and blue individually and then in combination.
- Colours change at a frequency of 1.5Hz.

**5mm**

CODE	Description	Unit	5+	1+
ECM599FLC	Rainbow Cycling LEDs	Pack of 10	5.50	5.95

## LED Holders Pack of 10



- Black plastic recessed holders for 5mm LEDs.
- Panel cutout size 8mm diameter for 5mm LED holder.

CODE	Description	Unit	5+	1+
ECM508LHL	LED Holders	Pack of 10	0.85	0.95

## MES Lens Ended Bulb Pack of 50



- MES (E10) screw bulbs with lens end for a pre-focused light beam.
- 9.8mm diameter.
- Overall length 24mm.
- 2.2V.

CODE	Description	Unit	5+	1+
ECM225LEN	2.2V	Pack of 50	6.50	6.95

## M.E.S. Bulbs 11mm Round Pack of 50



- MES (E10) screw bulbs.
- Available in 1.5, 2.5 and 3.5V.

**L 23mm 11mm Diameter**

CODE	Voltage	Unit	5+	1+
ECM155MES	1.5v	Pack of 50	6.50	6.95
ECM255MES	2.5v	Pack of 50	6.50	6.95
ECM355MES	3.5v	Pack of 50	6.50	6.95
ECM605MES	6.0V	Pack of 50	6.50	7.80

## M.E.S. Lampholder ABS Mounted Pack of 10



- Lampholder for M.E.S. bulbs, moulded in resilient white ABS.
- Spring loaded contact, cross-head screw connections.

CODE	Description	Unit	5+	1+
ECM152LPH	M.E.S. Lampholders	Pack of 10	2.95	3.25

### Miniature Slide Switch Pack of 10



- Miniature slide switch with break before make DPDT contacts, 0.5A 50VDC
- Solder tag connections.
- 2 x M2 fixing holes.

15 x 8 x 7mm

CODE	Voltage	Unit	5+	1+
ECM158MSS	Mini Slide Switch	Pack of 10	2.75	3.00

### Standard Toggle Switches Pack of 10



- Panel mounting toggle switch with solder tag terminals.
- Supplied with On/Off indicator plate. Nickel plated brass lever and bushing with a Phenolic base.
- Panel cutout: 12mm.
- Rated: 1.5A 250VAC.

L25 x H14 x W14mm

CODE	Description	Unit	5+	1+
ECM010TSW	Toggle Switches	Pack of 10	8.50	8.95

### Miniature Push Switch Pack of 5



- A low cost momentary (non-locking) action miniature panel mounting 'push to make' switch. Supplied with a fixing nut and washer.
- Rating: 0.3A 50VDC.
- Panel cutout: 7mm.

L28 x 10mm Diameter

CODE	Description	Unit	5+	1+
ECM115PSW	Mini Push Switch	Pack of 5	1.25	1.50

### Miniature Reed Switches Pack of 10



- General purpose magnetic reed switches, suitable for a wide range of sensing applications.
- Contact form SPNO, material Rhodium.
- 10VA switching capacity, max switching voltage 220VAC and max switching current 0.5A.

Body 18.5 x 2.6mm

CODE	Description	Unit	5+	1+
ECM220MRS	Mini Reed Switches	Pack of 10	11.25	12.25

### Battery Holders with Leads Pack of 10



- These holders are manufactured from tough and durable thermoplastic with leads attached.

CODE	Description	Unit	10+	1+
ECM211AAL	Holds 1 x AA	Pack of 10	1.95	2.25
ECM212AAL	Holds 2 x AA	Pack of 10	2.50	2.75

### Battery Holders with Studs Pack of 10



- These holders are manufactured from tough and durable thermoplastic with press stud style terminations which suit PP3 battery clips.

CODE	Description	Unit	10+	1+
ECM212AAS	Holds 2 x AA	Pack of 10	2.75	2.95
ECM214AAS	Holds 4 x AA	Pack of 10	3.95	4.35

### Battery Holders with Solder Tags Pack of 10



- These holders are manufactured from tough and durable thermoplastic with solder tags.

CODE	Description	Unit	10+	1+
ECM312CST	Holds 1 x C	Pack of 10	2.30	2.30
ECM411DST	Holds 1 x D	Pack of 10	2.80	2.80

### PP3 Battery Clips Pack of 100



- 9V PP3 battery clip with colour coded red and black 150mm wire leads, stripped and tinned 3mm.

CODE	Description	Unit	10+	1+
ECM010PPL	PP3 Battery Clips	Pack of 10	1.50	1.75
ECM510PPL	PP3 Battery Clips	Pack of 100	11.95	12.95

### Battery Boxes with Switches



- AA size battery boxes moulded in black ABS with detachable covers.
- Supplied with a miniature on-off slide switch.
- Connection via flexible red and black wire leads (150mm approx.).
- The lids may also be secured by the small screw provided.

1 x AA - L68 x W26 x H19mm  
2 x AA - L68 x W35 x H19mm  
4 x AA - L68 x W65 x H19mm

CODE	Description	Unit	5+	1+
ECM211AAB	1 x AA Box	1	0.55	0.65
ECM212AAB	2 x AA Box	1	0.85	0.95
ECM214AAB	4 x AA Box	1	1.25	1.60

## Button Cell 1.5V Pack of 2



- Alkaline button cell for electronic products, toys, games, digital equipment etc.

CODE	Description	Size	Unit	10+	1+
BAT442BLR	LR44	5.4x11.8mm	1	0.95	1.25 2.50

## JCB Batteries Super Alkaline C 1.5V Pack of 2



CODE	Description	Unit	10+	1+
BAT302CPK	Super Alkaline C	Pack of 2	1.95	2.05

## JCB Batteries Super Alkaline D 1.5V Pack of 2



CODE	Description	Unit	10+	1+
BAT402DPK	Super Alkaline D	Pack of 2	2.75	2.95

## Coin Cells 3V



- Lithium coin cells for electronic products, toys, games, digital equipment etc.

CODE	Description	Size	Unit	100+	10+	1+
BAT216CCR	CR2016	1.6 x 20mm	1	0.55	0.75	1.95
BAT225CCR	CR2025	2.5 x 20mm	1	0.55	0.75	1.95
BAT232CCR	CR2032	3.2 x 20mm	1	0.55	0.75	1.95

## JCB Batteries Super Alkaline AA 1.5V Pack of 10



CODE	Description	Unit	10+	1+
BAT210AAL	Super Alkaline AA	Pack of 10	2.50	2.95

## JCB Batteries Super Alkaline PP3 9V



CODE	Description	Unit	10+	1+
BAT901PPK	Super Alkaline PP3	1	1.60	1.75

## JCB Batteries Super Heavy Duty Zinc Chloride AA 1.5V Pack of 10



CODE	Description	Unit	10+	1+
BAT210AAZ	Super Heavy AA	Pack of 10	1.25	1.50

## JCB Batteries Super Alkaline AAA 1.5V Pack of 4



CODE	Description	Unit	10+	1+
BAT104AAA	Super Alkaline AAA	Pack of 4	1.15	1.35

## JCB Batteries Heavy Duty 996 6V



CODE	Description	Unit	10+	1+
BAT996LAN	Heavy Duty 996	1	4.80	4.95



# Consumables

---

**Sharpening**  
46

---

**Abrasives & Polishing**  
47-52

---

**Soldering**  
52-54

---

**Adhesives**  
55-59

---

**Finishes**  
60-64

---

**Lubricants & Pumps**  
65

TILGEAR

2023/24 ISSUE 58

Abrasives and Sharpening

## Norton India Oilstones

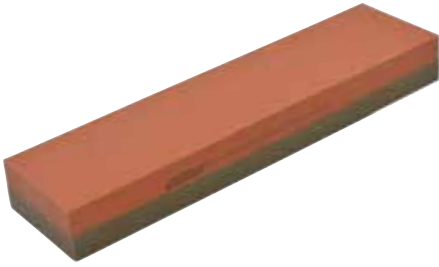

- Top quality aluminium oxide sharpening stones and slips - long lasting with excellent shape retention.
- Oil filled during manufacture - saving oil and reducing clogging in use.

8" x 2" x 1"

CODE	Grade	Unit	4+	1+
NRT85565B	Coarse/Fine	1	39.95	42.95

## Round Edge Slip Stones



- Ideal for deburring components and sharpening gouges.

4" x 1" / 11 to 5mm

CODE	Description	Unit	4+	1+
NRTMS14RE	Medium Grade	1	13.95	14.75

## Combination Oilstone & Box



- Combination oilstone with two different grits.
- Ideal for sharpening chisels, plane irons, knives etc.
- Used with light oil
- Stone dimension: 200 x 50 x 25mm.

CODE	Grade	Unit	4+	1+
CST820BOX	Oilstone & Box	1	7.25	8.25

## Optima Honing Oil 1 Litre



- High Quality light mineral oil for use with any oilstone.
- Lubricates the steel and the stone surface to prevent clogging.

CODE	Size	Unit	2+	1+
OPT01LHOL	1 Litre	1	13.50	14.95

## Eze-Lap Diamond Sharpening Plates



- American made diamond sharpeners manufactured by a patented heat treatment process.
- Cuts any hard materials - steels, carbides, glass, ceramics, HSS, TCT etc.
- Millions of high quality industrial diamond micro-crystals.
- Thick 1/4" steel base plate is made flat and will remain so during use.

8" x 3"

CODE	Grade	Unit	2+	1+
EZE86SFIN	Superfine	1	62.00	65.00
EZE86FINE	Fine	1	62.00	65.00
EZE86MEDM	Medium	1	67.50	69.25
EZE86COAR	Coarse	1	74.25	77.75

## Eze-Lap Hand Laps



- Convenient pocket/toolbox size measuring 6" x 3/4" overall with 2" diamond portion.
- Ideal for sharpening router cutters, saw blades, lathe tools.
- Slim section for easy access to cutting edge.
- Set comprises, superfine, fine and medium.

6" x 3/4"

CODE	Grade	Unit	4+	1+
EZELAPSET	Superfine, Fine, Medium	Set of 3	21.25	22.50

## Honing Guide



- The axle of the wheel has two opposing threads, which draws the jaws together simultaneously and clamps the tool.
- Used in conjunction with a sharpening stone - oil, water or diamond.
- Holds blades from 3mm to 67mm width.

CODE	Description	Unit	1+
HON70GUID	Honing Guide	1	10.95

## Pfeil Strop



- Used for years to produce a fine honed and polished edge on razors, cutting tools and knives.
- Fine calf leather is securely bonded to the polished hardwood base.

220 x 50 x 20mm

CODE	Description	Unit	1+
PFL1STROP	Pfeil Strop	1	28.75

## Polishing Cream



- A Unipol product for use on all stropps to produce that desired mirror finish! Supplied in a 125ml tube.

CODE	Size	Unit	1+
UNP125MPC	125ml Tube	1	9.50

### Drum Sander Set 25 Piece



- A comprehensive set with 5 different size rubber drums and 20 abrasive sleeves.
- Drums are expanded by a nut on the shaft to securely grip the sleeve.
- Can be held in a portable drill or drill press.
- Set contents:
  - 5 expanding drums: 1/2", 3/4", 1", 1 1/2", 2" diameter.
  - 20 abrasive sleeves: 2 fine and 2 coarse in each size.

CODE	Description	Unit	4+	1+
DSS25PSET	Drum Sander Set	1	13.25	14.25
DSS10PSLV	Pack of 10 Sleeves	1	5.50	5.95

### Wrap-round Drum Sander



- These sanding bobbins use a strip of 3" wide abrasive secured to a hard foam covered wooden core by a cam roller clamp.
- Ideal for use on a drill press or power tools.
- Supplied with a 3/8" or 1/2" shank.

CODE	Size	Unit	1+
WDS025380	1"/25mm	1	18.50
WDS050120	2"/50mm	1	21.00

### Abrasive Belt and Disc Cleaner



- Crepe rubber block which is pressed against a moving belt or disc and unloads debris in seconds.
- Maintains cutting efficiency and prolongs the abrasives useful life.
- Large economical size for hand held applications.

1 1/2" x 1 1/2" x 8"

CODE	Description	Unit	6+	1+
ABC11228A	Abrasive Belt and Disc Cleaner	1	9.50	9.95

### Sanding File



- Light and comfortable to use and double sided.
- A tension adjustment clamp pulls the abrasive taut.
- Suited for the 25mm /1" abrasive, working length 125mm.

CODE	Description	Unit	4+	1+
SDF125125	Sanding File	1	8.75	8.95

### Emery Cloth Dispenser



- Handy dispenser of emery type cloth for fine finishing.
- Contains four rolls in the following grits 150, 240, 320 and 400.
- For general use on metal, wood or plastics.
- 6m x 25mm of each grit.
- Four rolls of 6m x 25mm width.

#### 4 Rolls x 6m x 25mm

CODE	Description	Unit	4+	1+
ECD600025	Emery Cloth Dispenser	1	18.75	19.95

### Hanson Alox J Cloth Rolls



- Renowned for its flexibility and durability.
- Designed for metal finishing but also ideal for woodturning.
- Rolls of 25 metre available in 7 grits.

#### 25m x 25mm

CODE	Grit	Unit	2+	1+
ALX250060	60	1	19.95	20.95
ALX250100	100	1	18.95	19.95
ALX250150	150	1	18.95	19.95
ALX250240	240	1	18.95	19.95
ALX250320	320	1	18.95	19.95



### Resin Bonded Belts Pack of 10



- High quality abrasive.
- Suitable for wood, metal and plastics.

#### 1065 x 25mm

CODE	Grit	Unit	2+	1+
MRK210660	60	Pack of 10	27.95	28.50
MRK210680	80	Pack of 10	26.50	26.95
MRK210612	120	Pack of 10	26.50	26.95

#### 533 x 75mm

CODE	Grit	Unit	2+	1+
MRK753360	60	Pack of 10	23.50	25.75
MRK753380	80	Pack of 10	22.25	24.50
MRK753312	120	Pack of 10	21.75	23.95

#### 610 x 100mm

CODE	Grit	Unit	2+	1+
MRK161060	60	Pack of 10	25.75	28.25
MRK161080	80	Pack of 10	23.95	26.25
MRK161012	120	Pack of 10	22.95	25.25

#### 915 x 100mm

CODE	Grit	Unit	2+	1+
MRK191560	60	Pack of 10	38.95	42.95
MRK191580	80	Pack of 10	46.75	51.25
MRK191512	120	Pack of 10	36.95	40.75

#### 1220 x 100mm

CODE	Grit	Unit	2+	1+
MRK112260	60	Pack of 10	66.95	73.75
MRK112280	80	Pack of 10	65.25	71.75
MRK112212	120	Pack of 10	62.50	68.75

#### 1090 x 150mm

CODE	Grit	Unit	2+	1+
MRK109060	60	Pack of 10	92.95	102.25
MRK109080	80	Pack of 10	90.50	99.50

#### 1220 x 150mm

CODE	Grit	Unit	2+	1+
MRK122060	60	Pack of 10	95.95	105.50
MRK122080	80	Pack of 10	97.25	106.75

## Large Self-Adhesive Discs Pack of 10



- E-weight paper disc with self adhesive backing.
- Available in the two popular grits: 60 and 80 grit.

12"/305mm.

CODE	Grit	Unit	1+
SAD305060	60	Pack of 10	<b>29.95</b>
SAD305080	80	Pack of 10	<b>28.95</b>

## Large Hook & Loop Sanding Discs Pack of 10



- E-weight paper disc with hook and loop backing.
- Available in two popular grits: 60 and 80 grit.
- Size: 12"/300mm

CODE	Grit	Unit	1+
HLD305060	60	Pack of 10	<b>28.50</b>
HLD305080	80	Pack of 10	<b>27.50</b>

## Hanson Waterproof Abrasive Pack of 50



- Often referred to as 'Wet and Dry', this product is ideal for fillers, painted surfaces and composites.
- Full resin bonded silicon carbide abrasive.
- Waterproof latex backing paper.
- Available in 5 popular grits.



230 x 280mm

CODE	Grade	Unit	4+	2+	1+
WAP180PAK	180 Grit	Pack of 50	<b>15.95</b>	17.95	19.25
WAP240PAK	240 Grit	Pack of 50	<b>15.95</b>	17.95	19.25
WAP320PAK	320 Grit	Pack of 50	<b>15.95</b>	17.95	19.25
WAP400PAK	400 Grit	Pack of 50	<b>15.95</b>	17.95	19.25
WAP600PAK	600 Grit	Pack of 50	<b>15.95</b>	17.95	19.25

## Mirlon Abrasive Pads Pack of 20



- Abrasive impregnated non-woven nylon web giving effective cleaning and surface preparation with minimal stock removal.
- Ideal for providing overall key prior to applying finishes.
- Flexible nature allows complex contours to be worked with uniform contact.
- Can be used wet or dry.
- 3 grades.

230 x 150mm

CODE	Grade	Unit	2+	1+
MRKGNPP20	G. Purpose Green	Pack of 20	<b>22.25</b>	24.50
MRKFNP20	Fine Red	Pack of 20	<b>22.25</b>	24.50
MRKUFNP20	Ultra Fine Grey	Pack of 20	<b>22.25</b>	24.50
MRKMLNP60	1 x Each Pack (3x20)	3 x Packs of 20	<b>59.50</b>	

## Hanson Yellow Abrasive



- Hanson 'Yellow' a popular general purpose abrasive supplied in the industry standard and cost effective roll.
- Yellow aluminium oxide, bonded to a C-weight paper backing.
- Ideal for hand and light machine sanding.
- For use on wood, filler and painted surfaces.



115m x 50m Roll

CODE	Grade	Unit	2+	1+
HAN060YRL	60 Grit	1	<b>23.95</b>	25.95
HAN080YRL	80 Grit	1	<b>21.75</b>	22.95
HAN100YRL	100 Grit	1	<b>20.25</b>	21.95
HAN120YRL	120 Grit	1	<b>18.50</b>	19.95
HAN150YRL	150 Grit	1	<b>18.50</b>	19.95
HAN240YRL	240 Grit	1	<b>18.50</b>	19.95

## Hanson Glass Paper Pack of 50



- Traditional abrasive at a highly competitive price.
- Available in 5 grades.



230 x 280mm

CODE	Grade	Unit	4+	2+	1+
GLP040PAK	S2/40 Grit	Pack of 50	<b>7.50</b>	8.75	9.75
GLP060PAK	M2/60 Grit	Pack of 50	<b>6.50</b>	7.75	8.75
GLP100PAK	F2/100 Grit	Pack of 50	<b>6.50</b>	7.75	8.75
GLP150PAK	1/150 Grit	Pack of 50	<b>6.50</b>	7.75	8.75
GLP240PAK	00/240 Grit	Pack of 50	<b>6.50</b>	7.75	8.75

## Hanson Traffigrit Pack of 50 and 150



- Developed specifically for education utilising the traffic light colours to guide the user through the different grits.
- Instant recognition to guide students and assist teachers to check the correct grit is being used.
- Red is the first grade which is 80 grit for the initial work, Orange / Amber is 120 grit and a Green finishing paper of 240 grit.
- Aluminium oxide long lasting abrasive in three popular grits.
- The Assortment Pack contains a pack of 50 of each grit - a total of 150 sheets.



230 x 280mm

CODE	Description	Unit	4+	2+	1+
TGA080RED	80 Grit Red	Pack of 50	<b>13.95</b>	14.95	15.95
TGA120ORG	120 Grit Orange	Pack of 50	<b>12.95</b>	13.95	14.95
TGA240GRN	240 Grit Green	Pack of 50	<b>12.95</b>	13.95	14.95
TGA812ASS	Assortment Pack	Pack of 150	<b>35.00</b>	37.50	39.95



**Cork Sanding Block**  
Pack of 10



- Traditional cork block which gives the right feel and resilience when sanding.



100 x 62 x 25mm

CODE	Description	Unit	10+	4+	1+
CSB625P10	Cork Sanding Block Pck of 10		9.50	9.95	10.95

**General Purpose Sandpaper**  
Assorted Pack of 5



- Flint /glass abrasive paper.
- Suitable for general purpose hand sanding and paint preparation.
- Assorted grades.

230 x 280mm

CODE	Description	Unit	4+	1+
GLP500ASS	Assorted Sandpaper Pack of 5		2.25	2.50

**Mirka Waterproof Abrasive Sheets**  
Pack of 50



- High quality wet and dry paper with a full resin bond on special latex backing paper.
- Ideal for use on fillers, painted surfaces and composites..

230 x 280mm

CODE	Grit	Unit	2+	1+
MRK100WAP	100	Pack of 50	32.75	35.95
MRK120WAP	120	Pack of 50	28.75	31.50
MRK150WAP	150	Pack of 50	28.75	31.50
MRK240WAP	240	Pack of 50	28.75	31.50
MRK320WAP	320	Pack of 50	28.75	31.50
MRK400WAP	400	Pack of 50	28.75	31.50
MRK600WAP	600	Pack of 50	28.75	31.50
MRK800WAP	800	Pack of 50	28.75	31.50
MRK010WAP	1000	Pack of 50	28.75	31.50
MRK012WAP	1200	Pack of 50	28.75	31.50
MRK020WAP	2000	Pack of 50	32.75	35.95

**Mirka Hiomant Abrasive Roll**  
Pack of 25 or 50



- Heavy duty paper backed aluminium oxide abrasive for use on wood by machine or hand.
- Semi-open coat for reduced clogging with high removal rates.

230 x 280mm

CODE	Grit	Unit	2+	1+
MRK060HMT	60	1	37.50	41.25
MRK080HMT	80	1	33.95	37.25
MRK100HMT	100	1	31.75	34.95
MRK120HMT	120	1	31.75	34.95
MRK150HMT	150	1	31.75	34.95
MRK240HMT	240	1	31.75	34.95

SEE MACHINES & POWER TOOLS

**Sanders**  
Makita Palm Sander  
No.4555



**Mirka Carat Abrasive Roll**



- Grey stearated abrasive paper in a 50m roll, provides a fine to very fine option.
- It's zinc stearate coating reduces clogging and lends itself to fine work and cutting back finishes.

50m x 115mm

CODE	Grit	Unit	2+	1+
MRK180CRT	180	1	31.50	34.75
MRK240CRT	240	1	31.50	34.75
MRK320CRT	320	1	31.50	34.75
MRK400CRT	400	1	31.50	34.75

**Mirka Carat Abrasive Sheets**  
Pack of 50



- Open coated aluminium-oxide dry finishing paper with a flexible backing.
- Specially treated with a zinc stearate coating to minimise clogging.

230 x 280mm

CODE	Grit	Unit	2+	1+
MRK180C50	180	Pack of 50	21.50	23.50
MRK240C50	240	Pack of 50	21.50	23.50
MRK320C50	320	Pack of 50	21.50	23.50
MRK400C50	400	Pack of 50	21.50	23.50

**1/4 Sheet Sanding Mesh**  
Pack of 5

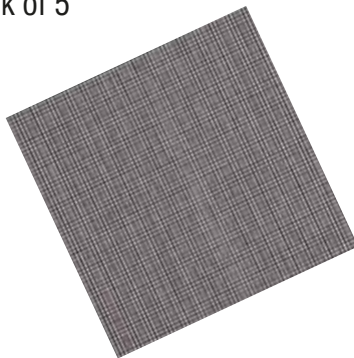

- Long-lasting abrasive mesh - for non-clogging and effective dust extraction.
- Fits all types of 1/4 sheet machines with hook and loop fastening.
- 1/4 sheet size - 115 x 115mm.

CODE	Grit	Unit	1+
ABR084QTS	80	Pack of 5	15.95
ABR124QTS	120	Pack of 5	15.95

**1/3 Sheet Abrasives**  
Pack of 5

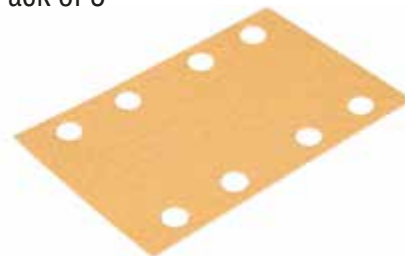

- High quality aluminium oxide abrasive.
- High strength heat and wear resistant backing paper to provide a superior lifespan.
- Hook and loop fastening 8 hole perforations to suit most 1/3 sheet sanders.
- 93 X 185mm.

CODE	Grit	Unit	2+	1+
ABR580THS	80	Pack of 5	4.70	5.25
ABR512THS	120	Pack of 5	4.70	5.25
ABR518THS	180	Pack of 5	4.70	5.25

## Mirka Gold Multi-hole 150mm Discs

Pack of 50 or 100

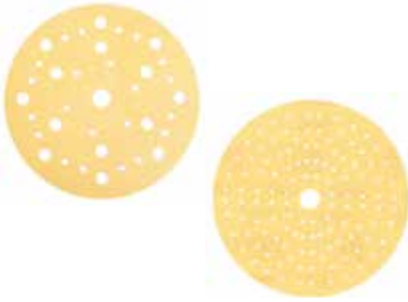

CODE	Grit	Unit	2+	1+
MRK060150	60	Pack of 50	<b>33.75</b>	36.95
MRK080150	80	Pack of 100	<b>70.50</b>	77.50
MRK120150	120	Pack of 100	<b>70.50</b>	77.50
MRK150150	150	Pack of 100	<b>70.50</b>	77.50
MRK240150	240	Pack of 100	<b>70.50</b>	77.50

## Mirka Gold Multi-hole 125mm Discs

Pack of 50



CODE	Grit	Unit	2+	1+
MRK12506H	60	Pack of 50	<b>31.50</b>	34.75
MRK12508H	80	Pack of 50	<b>30.50</b>	33.50
MRK12512H	120	Pack of 50	<b>28.95</b>	31.95
MRK12515H	150	Pack of 50	<b>28.95</b>	31.95

## Diamond Dresser



- Suitable for accurate dressing of wheels, to produce a finer surface finish.
- Removes glazed surface and restores cutting efficiency.

CODE	Description	Unit	1+
DDS141CRT	1 Carat Diamond Dresser	1	<b>16.95</b>

## Abrasive Discs



- Extra-thin high performance disc (down to 1mm) which gives 50% faster cutting time, 50% less consumption of power, 50% less dust and 50% longer life.
- Diameter: 115mm
- Bore: 22.2mm
- Thickness: Extra Thin - 1.0mm / Depressed Centre - 6.0mm.

### Extra Thin Abrasive Cutting Discs

CODE	Material	Unit	10+	1+
ABD115SST	Stainless Steel	1	<b>1.80</b>	1.95
ABD115STL	Steel	1	<b>1.80</b>	1.95
ABD115ALU	Alu/Non-Ferrous	1	<b>1.80</b>	1.95

### Depressed Centre Grinding Discs

CODE	Material	Unit	10+	1+
ABD115DPC	Steel	1	<b>1.80</b>	1.95

## General Purpose Grinding Wheel



- Aluminium oxide vitrified grinding wheels are suitable for use on most types of bench grinders and are suitable for normal grinding of ferrous metals.

CODE	Size	Description	Unit	1+
GWL634ALX	6" x ¾"	Gen. Purpose	1	<b>16.75</b>
GWL810ALX	8" x 1"	Gen. Purpose	1	<b>29.95</b>

## Huntingdon Pattern Star Wheel Dresser



- An effective device which uses rotating spiked wheels to open up and sharpen the grinding wheel.
- Suitable for larger wheels, up to 20" diameter.
- Spare spiked wheels available.

CODE	Description	Unit	1+
SWD020N00	Star Wheel Dresser	1	<b>12.75</b>
SWD114WHL	Replacement Wheels	1	<b>4.95</b>

## Zirconium Flap Discs

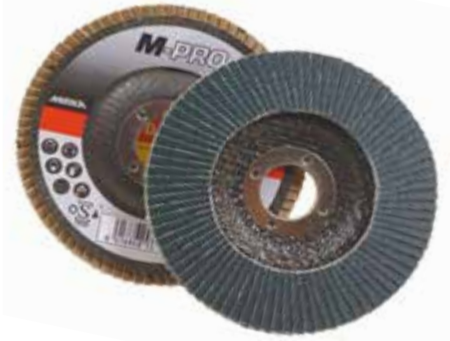

- Extremely durable Zirconium abrasive wheels for use on 4 ½"/115mm angle grinders with 7/8"/22mm bore.
- Layered abrasive rapidly removes weld, rust, paint etc.
- Available in grits 40 and 60.

CODE	Grit	Unit	10+	1+
MRK040FLD	40 Grit	1	<b>7.25</b>	7.95
MRK060FLD	60 Grit	1	<b>7.25</b>	7.95

## White Grinding Wheel



- White wheel for general sharpening, often preferred for sharpening high carbon and HSS woodworking tools.
- Fast cutting and cool running.

CODE	Size	Description	Unit	1+
GWL634WHT	6" x ¾"	White	1	<b>26.75</b>
GWL810WHT	8" x 1"	White	1	<b>46.75</b>

## Green Silicon Carbide Grinding Wheel



- Green grit wheel for grinding tungsten carbide such as lathe tools and masonry drills.

CODE	Size	Description	Unit	1+
SLC634GRN	6" x ¾"	Green	1	<b>24.95</b>
SLC801GRN	8" x 1"	Green	1	<b>43.50</b>

## HSS Router Cutter Set 6 Piece Set



- 2, 3, 5 and 7 x 2mm and point HSS router bits with 3.1mm diameter mandrels.
- Max speed 28,000rpm.

CODE	Description	Unit	3+	1+
MRT600SET	6 Piece Set	1	4.60	4.95

## Miniature Rotary Accessory Kit



- Set of 105 accessories for high speed rotary tools.
- Contains steel burrs, abrasive points, wire and nylon brushes, drum sanders, cut off wheels and mandrel felt points, felt heads, mandrel and polishing compound.

CODE	Description	Unit	3+	1+
MRA100KIT	105 Piece Set	1	11.75	12.75

## Drill Brushes



- Handy robust wheel and cup wire brushes for use in an electric drill. 1/4" shank.

### Wheel

CODE	Size	Unit	4+	1+
DRB100WHL	100mm	1	3.20	3.50

### Cup

CODE	Size	Unit	4+	1+
DRB070CUP	70mm	1	3.10	3.30

## Carbrax SMG Polishing Compound



- Very fast cutting for preliminary polishing of steel and stainless steel, and for initial abrasive finishing on non-ferrous metals.

CODE	Compound	Approx Bar Weight	Unit	4+	1+
CAN800CAR	Carbrax SMG	800g	1	11.95	12.75

## Hyfin Polishing Compound



- For final finishing of steels, stainless steels and non-ferrous metals.
- Clean and fast cutting, and removes fine abrasive marks.

CODE	Compound	Approx Bar Weight	Unit	4+	1+
CAN750HYF	Hyfin	750g	1	9.95	10.75

## Lustre Polishing Compound



- High quality tripoli which combines a fine finish with rapid working.
- Ideal for the preparatory polishing of non-ferrous metals and plastics.

CODE	Compound	Approx Bar Weight	Unit	4+	1+
CAN700LUS	Lustre	700g	1	5.95	6.50

## AA Rouge Polishing Compound



- High quality extra fine rouge for final polishing of precious metals and non-ferrous metals.

CODE	Compound	Approx Bar Weight	Unit	4+	1+
CAN450ROU	AA Rouge	450g	1	6.95	7.75

## Steelbrite Polishing Compound



- Blue composition used for mirror finishing stainless steel and a range of non-ferrous metals.

CODE	Compound	Approx Bar Weight	Unit	4+	1+
CAN800STB	Steelbrite	800g	1	9.25	9.95

## Steelcut Polishing Compound



- Fast cutting giving a bright finish on steel and stainless steel, and an initial abrasive polish on non-ferrous metals.

CODE	Compound	Approx Bar Weight	Unit	4+	1+
CAN890STC	Steelcut	890g	1	12.50	13.50

## Vonax Polishing Compound



- General purpose for producing a high gloss finish on most plastics.

CODE	Compound	Approx Bar Weight	Unit	4+	1+
CAN710VON	Vonax	710g	1	8.50	8.95

## Flap Wheels



- The flexible and long lasting aluminium oxide flaps are secured with a resin bond for extra strength and service life.
- Ideally suited for sanding shaped and curved workpieces.
- Integral 6mm shank which suits most power drills.

CODE	Size	Grit	Unit	3+	1+
FPW638FNE	60 x 30mm	80 Grit	1	4.95	5.50

## Unstitched Open Polishing Mops



- Soft cotton mops suitable for final finishing and for use on delicate or irregular surfaces.
- Mounting designed for tapered spindles.

CODE	Size	Unit	4+	1+
UST6100MP	6" x 1"	1	15.00	17.50
UST8100MP	8" x 1"	1	22.00	23.25

## Stitched Polishing Mop



- White stitched cotton mops are the best all round general purpose mop.
- Mounting designed for tapered spindles.



CODE	Size	Unit	4+	1+
STT6100MP	6" x 1"	1	10.75	11.75
STT8100MP	8" x 1"	1	14.00	16.00

## Satin Mop



- 6" diameter wheel laminated from 4 discs of 'Mirion' type material.
- Gentle action quickly produces a satin finish on metals.
- Wheel width: 2" (approx) for tapered arbor mounting.



CODE	Description	Unit	10+	4+	1+
SAT642MOP	Satin Mop	1	11.95	12.50	13.50

## Antex Pyrography Set Fire Writer



- This professional pyrograph features an adjustable temperature control up to 650 °C.
- 40W slim pyrography pen having optional interchangeable tips.
- Tips are either the standard pre-formed wire type or a clamp type which accepts Nickel Chrome wire to your specification.

CODE	Description	Unit	2+	1+
ANT650FRW	Pyrography Set	1	241.50	261.50

## Antex Pyro Master Set



- A pyrography set built around Antex's extensive manufacturing knowledge of soldering irons.
- Burning iron, 25 watt, 240 volt.
- Simple and safe to use, held as a pen.
- Supplied with 19 interchangeable tips for wood and leather.

CODE	Description	Unit	4+	1+
ANT182PYR	Pyrography	1	41.50	45.25

## Antex Soldering Iron XS25 Silicone



- A mains operated 25 watt soldering iron made in the UK.
- The highly efficient heater element is inside the soldering tip ensuring that all the heat flows directly into the tip.
- Tests have proven that it has the equivalent soldering power to a conventional 40w iron.
- Supplied with a burnproof silicone rubber flex for extra safety and 3mm tip.
- 0.5mm, 2.3mm and 3mm tips available as extras.

CODE	Description	Unit	10+	4+	1+
ANT58J470	XS25 Silicone	1	33.75	35.75	38.95
ANT055L60	Replacement 1.0mm Tip	1			5.95
ANT050L60	Replacement 2.3mm Tip	1			5.95
ANT051L60	Replacement 3.0mm Tip	1			5.95

## Antex 30W Soldering Iron ER30



- The ER30 represents excellent value for money as we bulk purchase these for schools and colleges.
- Supplied with a standard tip.
- Includes a simple stand, not for use with Antex ST4.

CODE	Description	Unit	10+	4+	1+
ANT30WERS	ER30	1	18.75	19.95	22.25
ANT300TIP	Replacement 0.5mm Tip	1			5.50

## Antex CS18 Soldering Iron Silicone



- This popular 18W mains soldering iron is ideal for precision use and fitted with a burn-proof silicone cable which is ideal for educational environments.
- Inner ceramic shaft provides near perfect insulation.
- Supplied with long-life iron plated bit 2.3mm.
- UK made and CE marked.

CODE	Description	Unit	10+	4+	1+
ANT48J470	CS18 Silicone	1	33.95	35.95	39.25
ANT106TIP	Replacement 1mm Tip	1			5.95
ANT100TIP	Replacement 2.3mm Tip	1			5.95

## Antex HP100 Soldering Iron



- Heavy duty 100W iron ideal for higher power soldering applications.
- It is particularly useful when working with electrical wires or larger contacts rather than PCB work. CE marked.
- Large tip mass, plated for long-life.
- 230 volt with UK plug and 1.5 meter rubber lead.
- Soldering iron stand included.

CODE	Description	Unit	10+	4+	1+
ANT100HPW	HP100	1	27.75	29.50	32.50
ANT030TIP	Replacement 1mm Tip	1			14.50

## Stromberg Soldering Iron 30W Silicone Cable



- A 30W / 240V soldering iron designed for education with a burn-proof silicone cable
- Contoured handle with a flared end to prevent the fingers slipping on the hot iron.
- Precision replaceable solder point to suit most applications.
- Use only with the simple stand supplied.

CODE	Description	Unit	10+	4+	1+
SBG030SDS	30W Silicone	1	9.95	10.95	12.50
SBG030TIP	Replacement Tip	1			4.50

## Soldering Kit 3 Piece Set



- Popular soldering kit featuring the silicone cabled soldering iron for safe soldering.
- Includes a simple stand, lead-free solder and desoldering pump.

CODE	Description	Unit	4+	1+
SDR300SET	3 Piece Set	1	18.95	19.95

## Lead-Free and Rosin Free Solder



- Specially developed high quality flux cored solder to suit educational establishments.
- A safe, lead-free product, which contains no Rosin (or Resin Acid).
- Meets and exceeds all current regulations for lead-free applications.
- High purity - over 99% Tin with 0.5 – 0.9% copper.
- 0.8mm diameter flux cored - easy to use.
- Supplied in either 100g, 250g or 500g.

CODE	Size	Unit	4+	1+
LFS100FLX	100g	1	13.95	15.50
LFS250FLX	250g	1	21.50	23.95
LFS500FLX	500g	1	39.95	44.50

## Antex Digital Soldering Station 690D



- Professionally rated digitally controlled soldering station, designed to be used in industrial and educational environments.
- Fully compatible with the latest EMC and CE regulations
- Station includes a 230V AC power supply, ST6A iron stand and a lightweight 24V / 50W industrial grade soldering iron.
- Temperature range continually adjustable from 200°C to 450°C.
- Housed in a robust metal enclosure with a silicone heat-resistant cable and a 2.3mm tip.

CODE	Description	Unit	2+	1+
ANT690DTL	Antex Digital	1	248.95	263.25

## Desoldering Pump

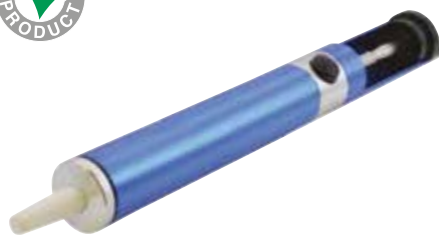

- High suction pump with automatic ejection.
- Finest quality all-metal construction.
- Heavy duty return spring and close tolerance manufacture give extra-high suction.
- Teflon nozzle.

19 x 129mm

CODE	Description	Unit	10+	4+	1+
DSP340SUC	Desoldering Pump	1	4.50	5.25	5.50

## Omega Rosin Free Solder



- This flux cored solder wire contains no rosin or resin acid - specifically designed to help reduce the number of cases of industrial asthma.
- The high purity, fast flow solder has excellent wetting capability and is supplied on a 250g reel.
- 63% Tin
- 37% Lead

1.2mm Diameter

CODE	Size	Unit	4+	1+
OMG250RFS	250g	1	19.95	21.95

## Stromberg Soldering Iron Stand



- Traditional stand with a spring steel holder and weighted base.
- Designed to be used with most iron including the SBG030SDS.
- Includes a replaceable tip sponge.

85 x 125mm

CODE	Description	Unit	10+	4+	1+
SBG135SND	Soldering Stand	1	4.50	5.25	5.50
SBG135SPG	Replacement Sponge	1	1.00	1.50	1.75

## Antex Bench Stand ST4



- Designed to suit the XS25 and CS18 irons (not ER30).
- Convenient safety stand that can be screwed to the bench.
- Includes a replaceable tip sponge insert.

CODE	Description	Unit	10+	4+	1+
ANT400020	Bench Stand	1	6.75	7.25	7.95
ANT114SPG	Spare Sponge	1	1.60	1.75	1.95

## Antex Lead-Free Solder



Ideal for use on microelectronics, fine wires and most other electrical and electronic soldering applications.

- 0.8mm lead-free solder composed of 99.25% tin and 0.75% copper.
- Melting point at 207°C to 217°C.
- Suitable for use with all Antex soldering irons.

4m Length

CODE	Description	Unit	10+	4+	1+
ANT408LFS	Lead-free Solder	1	4.95	5.50	5.95

## Fluxed Solder



- Electrical solder 60:40 tin/lead for electrical and electronic work.

### 1mm Diameter

CODE	Size	Unit	4+	1+
SLD100FLX	100g	1	<b>5.25</b>	5.75

## Solder Dispenser



- A convenient method of dispensing solder.
- Accepts most 500g reels of all gauges of solder.
- Spring guide holds end at convenient height and position.
- Heavy base maintains excellent stability.
- Supplied unassembled, solder not included.

CODE	Description	Unit	4+	1+
SLD500DPR	Solder Stand	1	<b>10.25</b>	10.95

## Bakers No.3 Soldering Fluid



- Specially formulated liquid flux ideal for soldering and tinning of copper and tinned materials.
- Easy to apply.
- Fast acting and economical in use.
- Ensures a sound strong joint.

CODE	Weight	Unit	4+	1+
BAK250SDF	250ml	1	<b>14.00</b>	14.50

## Delta Tip Tinner 1oz Tin



- Delta Tip Tinner is a speedy and effective product for restoring, cleaning and re-tinning de-wetted soldering iron tips that cannot be re-tinned by sponges, pads or rosin cored solder wire.
- Simply wipe your soldering iron tip across the surface of the product, then apply solder.

CODE	Weight	Unit	4+	1+
DEL965TPT	1oz	1	<b>16.95</b>	18.75

## Blowpipe Solder



- Commercial grade 37/63 lead/zinc solder for sheet metalwork and hand soldering.
- Melting range 183°-240°C. Supplied in strips.

### 5 x 3 x 560mm Length

CODE	Description	Unit	10+	1+
BLP560SOL	Blowpipe Solder	1	<b>2.95</b>	3.50

## Fluxite Soldering Paste



- An effective and reliable flux paste which simplifies soldering and lead jointing.
- Suitable for lead-free and lead containing solder alloys.
- Quick and clean to use.
- Complies with water research council requirements.
- UKWBF listed and approved by British Gas.

CODE	Weight	Unit	4+	1+
FLX100SLP	100g	1	<b>9.95</b>	10.95

## Easy-Flo Flux Powder



- Well-known flux for general purpose applications.
- Working range of 550° - 800°C and can be used for most brazing operations.
- Easily removed with hot water.

CODE	Type	Weight	Unit	1+
JMT250ESY	Easy-Flo	250g	1	<b>21.25</b>

## Johnson Matthey Silver Solder Silver-Flo No.55

- This is the general-purpose cadmium free silver solder, with a short melting range and a melting temperature of 630°-660°C.
- High silver content of 55%, easy to use.
- Ideal for use in schools and colleges and for manufacturing food equipment.



## Johnson Matthey Silver Solder Silver-Flo No.24

- A high temperature cadmium free rod melting at 740°-800°C. Suitable for use as the first alloy in step brazing, and for copper boilers where high temperatures may occur.



CODE	Type	Size	Unit	4+	1+
JMT015S55	Silver-Flo 55	1.5 x 600mm	1	<b>9.50</b>	9.95
JMT015S24	Silver-Flo 24	1.5 x 600mm	1	<b>8.50</b>	8.95

## Threadlocker Nutlock



- Prevents vibration loosening of threaded fasteners, and seals against corrosion and leakage.
- 10ml bottle, medium strength general purpose.
- Removable with hand tools.

CODE	Description	Unit	6+	1+
RTL4210ML	10ml	1	<b>5.95</b>	6.25

### Acrylic Solvent Cement



- As fast acting solvent cement for bonding plastics such as acrylic, HIPS and ABS.
- Thin consistency for good penetration – not gap filling.
- Easily applied with the syringe system.

CODE	Size	Unit	4+	1+
DUR500ASC	500ml	1	8.95	9.95
DUR109ASC	1 litre	1	15.95	16.50

### Syringe System Pack of 100



- This syringe system enables small quantities of adhesive and lubricant to be precisely dispensed onto a project.
- Ideal for Acrylic Solvent Adhesive and other glues.
- 2 part syringe with no rubber plunger to dissolve.
- Blunt needle for safe use.
- Needle size - 40mm x 1.5mm.

CODE	Size	Unit	2+	1+
SYR102BOX	Syringe 2ml Pack of 100	1	16.50	18.95
NED180BLT	Blunt Needle Pack of 100	1	29.95	32.95

### Duribond Rapid Epoxy Adhesive 5 Minute - 25ml Syringe



- Industrial strength fast setting, clear drying epoxy adhesive supplied in a twin syringe for easy application.
- Starts to hold in just 5 minutes.
- Suitable for bonding metal, crockery, hard plastics, fibreglass, stone, ceramic, wood, concrete and glass.
- May be drilled and sanded.

CODE	Description	Unit	12+	6+	1+
DUR025EPR	25ml	1	3.95	4.50	4.95

### Duribond Rapid Epoxy Adhesive 5 Minute - 250ml Bottles



- Industrial strength fast setting, clear drying epoxy adhesive supplied in 2 x 125ml (250ml) bottles of hardener and resin.
- Starts to hold in just 5 minutes.
- Suitable for bonding metal, crockery, hard plastics, fibreglass, stone, ceramic, wood, concrete and glass.
- May be drilled and sanded.

CODE	Description	Unit	6+	1+
DUR250EPR	250ml	1	21.95	23.95

### Polyurethane Wood Adhesive Liquid 750ml



- High strength polyurethane adhesive in a liquid form.
- 100% waterproof.
- Sets hard in 30 minutes.
- Conforms to EN 204. D4 Strength.

CODE	Size	Unit	12+	4+	1+
EVE3075PU	750ml	1	16.50	17.50	19.50

### Gorilla Glue



- Premium all purpose polyurethane interior/exterior glue.
- Bonds wood, stone, metal, ceramic and more!
- Incredibly strong and 100% waterproof.

CODE	Size	Unit	2+	1+
GRGL50004	115ml	1	8.95	9.95
GRGL50008	250ml	1	13.50	14.95
GRGL50016	500ml	1	22.50	24.95

### Titebond Original Aliphatic Wood Glue



- Original aliphatic resin glue with a strong initial tack, a fast set and a superior bond strength.
- Non-toxic and cleans up with water, easily sanded when cured.
- Excellent heat and solvent resistance, and unaffected by finishes.
- Superb results on all timbers.

CODE	Size	Unit	6+	1+
TB50630RG	237ml/8oz (US)	1	6.50	6.95
TB50640RG	473ml/16oz (US)	1	9.25	9.75
TB50650RG	946ml/32oz (US)	1	12.50	13.25
TB50660RG	3.785 ltr/1 Gal (US)	1	33.95	35.95

### Titebond II Premium Aliphatic Wood Glue



- Strong initial tack, a fast set and a superior bond strength.
- Non-toxic and cleans up with water, easily sanded when cured.
- Excellent heat and solvent resistance, and unaffected by finishes.
- Water resistant glue designed for exterior projects, kitchen worktops etc.
- Ideal for R.F gluing systems and approved for indirect food contact.

CODE	Size	Unit	6+	1+
TB5004PRM	473ml/16oz (US)	1	10.95	11.50
TB5006PRM	3.785 ltr/1 Gal (US)	1	40.25	42.50

### Titebond III Ultimate Aliphatic Wood Glue



- Waterproof formula passes the ANSI/HPVA Type 1 water-resistance specification.
- Strong initial tack, a fast set and a superior bond strength
- Offers superior bond strength, longer open assembly time and lower application temperature.
- Excellent heat and solvent resistance, and unaffected by finishes.
- Ideal for both interior and exterior applications.

CODE	Size	Unit	6+	1+
TB1414ULT	473ml/16oz (US)	1	14.25	14.95
TB1416ULT	3.785 ltr/1 Gal (US)	1	56.75	59.95

Adhesives

## Duribond PVA Adhesive High Strength DB5



- High quality general purpose adhesive producing a stronger than wood bond.

CODE	Size	Unit	12+	4+	1+
DUR1KGDB5	1kg	1	6.75	7.25	7.95

CODE	Size	Unit	8+	4+	1+
DUR5KGDB5	5kg	1	23.75	25.25	27.95

## Duribond PVA Adhesive Water Resistant DB3



- Superior cross-linking PVA to give a water resistant bond for both interior and exterior use.

CODE	Size	Unit	12+	4+	1+
DUR1KGDB3	1kg	1	7.25	7.75	8.75

CODE	Size	Unit	8+	4+	1+
DUR5KGDB3	5kg	1	25.25	26.95	29.95

## Duribond PVA Adhesive Fast Setting DB7



- Special formulation for a fast grab and set, also water resistant.

CODE	Size	Unit	12+	4+	1+
DUR1KGDB7	1kg	1	10.50	11.50	12.95

## Empty Glue Containers Pack of 10



- 500ml container (187mm high) with a nozzle cap.
- Semi-transparent so the level can be easily seen.

CODE	Size	Unit	4+	1+
EGC500P10	500ml	Pack of 10	12.50	13.75

## Pump Dispenser



- For use in dispensing liquid from a 5 litre container – ideal for PVA.
- One pump dispenses a 30ml dose.
- 38mm closure fitment.

CODE	Description	Unit	4+	1+
PMP538DPR	Pump Dispenser	1	3.80	4.20

## Cascamite One Shot Adhesive 1.5kg Tub



- A powder system with extremely good gap filling properties ensuring no water penetration of the joint, producing the strongest bond.
- Attains bond strength very quickly, enabling it to be used for load bearing and laminating.
- For use externally and internally.
- Clear glue line, non staining and mould resistant.
- Makes 50% more when mixed.

CODE	Size	Unit	2+	1+
CAS015ADH	1.5kg	1	19.50	20.95

## Copydex Glue



- Solvent-free as it's made from latex dissolved in water, 100% - natural ingredients and is less toxic than many other rubber cements.
- Dries quickly, touch dry in 15-20 minutes.
- Perfect for paper, card, wood, plastics, metal, cork, fabric, carpets, leather, canvas and many other materials.
- Resistant to washing machine cycles, which makes it ideal for repairing clothes.

CODE	Description	Unit	6+	1+
CPX125GLU	125ml	1	6.75	7.50
CPX500GLU	500ml	1	15.50	16.75

## Balsa Cement



- Traditional adhesive for bonding balsa and light timbers.
- 24ml tube.

CODE	Size	Unit	6+	1+
BSL024CMT	24ml	1	2.50	2.75

## All Purpose UHU Adhesive



- All purpose is a perfect glue for everyday jobs around the house, school, office or handicrafts.
- Sticks paper, wood, cardboard, fabrics, leather, pottery, glass, china, marble, metal, felt and cork.

CODE	Description	Size	Unit	5+	1+
UHU035APA	Tube	35ml	1	3.20	3.50
UHU125APA	Tube	125ml	1	5.50	5.95



**Duribond Glue Station**



- Enables adhesives or finishes to be kept fresh and available at any time.
- 0.9 Litre tank is filled by tipping the container on its back, which when righted will automatically fill and top up the front reservoir as the liquid is used.
- Large pointed cap provides an airtight seal over the reservoir and brush preventing evaporation. Supplied with glue brush.

CODE	Description	Unit	4+	1+
DUR09LG10	Glue Station	1	11.25	11.75

**Duribond Hot Melt Glue Gun**



- A hand-held glue gun for use with wood, fabric, ceramics, plastics etc.
- Smooth trigger action gives excellent control and easy flow of glue.
- Uses adhesive sticks 11/12mm in diameter.
- Supplied with double insulated lead and approved mains plug.

CODE	Wattage	Unit	12+	4+	1+
DUR40WHMG	55W	1	9.95	11.50	12.50

**All Purpose Contact Adhesive**



- Premium grade rubber based contact adhesive.
- Suitable for use internally and externally to bond decorative laminates, all types of wood, rigid PVC, ABS, leather, cork, linoleum, rubber, stone, metals and dense fabrics.

CODE	Size	Unit	6+	1+
EVE750CAD	750ml	1	22.75	25.25

**Cool Melt Glue Gun**



- Runs at a lower temperature to lessen the possibility of burns.
- For bonding paper, plastic, wood, ceramics and some metals.
- Power 20W - 240V.

CODE	Description	Unit	10+	5+	1+
CMG020GUN	Cool Melt	1	8.95	9.95	10.75

**Duribond Professional Glue Gun**



- Powerful 60W element with a long lever arm trigger giving accurate control or high volume flow.
- Fitted with a neon indicated on/off switch.
- Operates with 11/12mm sticks.
- Supplied with approved 240v plug and double insulated lead.

CODE	Wattage	Unit	12+	4+	1+
DUR60WHMG	60W	1	14.95	15.95	17.50

**Thixofix Contact Adhesive**



- Powerful multi-purpose adhesive, strong bonding.
- Thixotropic for clean, easy application.

CODE	Size	Unit	6+	1+
THX0250CA	250ml	1	10.00	10.75
THX0500CA	500ml	1	15.25	15.75

**Cool Melt Glue Sticks Pack of 12**



- Only for use in the Cool Melt Glue Gun.
- Runs at a lower temperature to lessen the possibility of burns.
- Diameter 7mm x 100mm long.

CODE	Description	Unit	10+	5+	1+
CMG120PAK	Cool Melt	1	3.20	3.50	3.95

**Duribond Hot Melt Glue Sticks**



- A general purpose glue stick for bonding wood, paper, fabrics, plastics, leather, metal, bricks, tiles etc.
- Available in 12mm x 280mm for standard and professional guns.
- Bonds in less than a minute.
- Waterproof and low toxic, no fumes and solvents.

12mm x 280mm

CODE	Description	Size	Unit	4+	1+
DUR01KGHM	33 Sticks	1kg	1	9.95	11.25
DUR05KGHM	165 Sticks	5kg	1	45.00	49.50

**Spray Contact Adhesive**



- Sprayable glue Contact Adhesive which bonds to most common materials including wood, concrete, stone, tiles, rubber, foam, metals, rigid plastics, polyethylene, canvas fabrics, cardboard, paper and cork.
- Suitable for internal and external use, giving permanent or temporary adhesion.

CODE	Size	Unit	12+	1+
EVE501SCA	500ml	1	6.50	7.25

## Mitre Kit



- Developed for kitchen fitters to join cornice mitre joints.
- Lends itself to fast bonding in applications such as picture framing etc.
- Comprises one 50g container of cyanoacrylate superglue and one 200ml activator spray.

CODE	Description	Unit	4+	1+
DUR83206K	Mitre Kit	1	9.95	10.95

## Superglue Activator



- Promotes rapid curing, particularly on difficult surfaces.
- Can be applied before or after assembly.
- Spray applicator bottle - 200ml.
- Available in two grades, either for wood or plastic substrates.

**200ml**

CODE	Size	Unit	12+	1+
TFL750WOD	Wood Grade	1	7.75	8.50
TFL780PLA	Plastic Grade	1	7.75	8.50

## Duribond Superglue



- Well known cyanoacrylate adhesive which cures in seconds and gives high strength bonds on most materials.
- Bonds rubber, some plastics, wood, leather, ceramics, glass, metal etc.
- Resistant to solvents and moisture.
- Available in three different 20g viscosities:-
  - Thin - tight joints, quick setting.
  - Medium - general purpose.
  - Thick - slower setting, gap filling.

CODE	Size	Unit	12+	4+	1+
DUR83203T	20g Thin	1	3.95	4.75	4.95
DUR83204M	20g Medium	1	3.95	4.75	4.95
DUR83205K	20g Thick	1	3.95	4.75	4.95

## Super Glue and De-bonder



- Useful pack containing 3g of super glue and 3g of debonder High strength adhesive, impact resistant bond.
- Sets fast but you have the option to de-bond if necessary.

CODE	Size	Unit	6+	1+
SGL303DEB	Glue & Debonder	1	1.35	1.50

## PVA Craft Glue



- A great value water-based PVA craft glue for use on paper, card, fabric, decoupage, embellishments and more.
- Fast drying and bonds clear.
- Non-toxic and washable.

CODE	Description	Unit	6+	1+
PVA250CRF	250ml	1	1.35	1.50
PVA500CRF	500ml	1	3.80	4.20
PVA001CRF	1 litre	1	6.95	7.95
PVA005CRF	5 litre	1	17.75	19.75

## Bison Model Plastic



- Transparent adhesive for ABS, acrylic, polycarbonate and rigid PVC.
- Strong and waterproof
- Temperature resistant up to 100°C

CODE	Size	Unit	12+	5+	1+
BSN251PLA	25ml	1	3.95	4.50	4.75

## Art & Craft Spray Adhesive



- A non-staining special adhesive spray for an instant re-positionable and secure bond.
- Many uses in textile screen printing, picture framing/ mounting, art and craft activities etc.
- Can be used on paper if sprayed lightly.
- For repositionable mounting, apply to just one surface - for a secure permanent bond, apply to both surfaces.

CODE	Description	Size	Unit	12+	6+	1+
ACA200SPY	Aerosol	200ml	1	4.50	5.00	5.50

## Hammerite Aerosol



- Hammerite is corrosion resistant and is suitable for use on a wide range of exterior metal including gates, railings, drainpipes, guttering and garden furniture.
- Touch dry in an hour
- Supplied as an aerosol for easy application.

CODE	Finish	Colour	Size	Unit	1+
HAM400SBK	Smooth	Black	400ml	1	12.95

## Hammerite



- Hammerite Direct to Rust Metal Paint can be painted directly onto rusty surfaces and, thanks to its special 3 in 1 formula; there is no need to use a primer or undercoat.
- Touch dry in an hour.
- Protects for up to 8 years, both inside and outside.

CODE	Finish	Colour	Size	Unit	1+
HAM750SBK	Smooth	Black	750ml	1	23.95

## Large String Ball



- Cotton string has many uses in classroom or workshop.

CODE	Description	Unit	10+	4+	1+
SRG200BAL	Large Ball	1	2.25	3.00	3.25

## Clear Tape Pack of 12



- A universal general purpose clear tape for use in the home, work or school.
- For more convenience, use with a desk dispenser.
- Pack of 12 - 24mm wide x 40m length reels.

CODE	Description	Unit	6+	2+	1+
CTP244CLR	Clear Tape Pack of 12		5.50	5.95	6.50

## Hazard Tape 30m Length



- Yellow and Black PVC 50mm x 30m.
- Ideal for indicating hazardous areas.

### 50mm x 30m

CODE	Colour	Unit	6+	1+
HTP533YBL	Yellow and Black	1	5.50	6.25

## Hand Tape Dispenser



- Design for use with 50mm tape
- Fitted with brake to retain the tape end

CODE	Description	Unit	4+	1+
HTD050WBR	Dispenser	1	4.50	5.00

## Brown Vinyl Parcel Tape 66m Length



- Standard core size for tape dispensers.

### 48mm x 66m

CODE	Colour	Unit	36+	1+
PTP550BRV	Brown	1	1.50	2.25

## Double Sided Tape 33m Length



- A popular tape for many applications in and around the workshop and classroom.
- Ideal for temporary holding of materials or attaching structures together.
- Suitable for mounting posters and general bonding.

### 12mm x 33m

CODE	Description	Unit	10+	4+	1+
DAT123DST	Doubled Sided Tape	1	2.25	3.00	3.25

## Desk Tape Dispenser



- Ideal for keeping your 24mm clear tape ready for use.
- Tough robust body.

CODE	Description	Unit	4+	1+
DTD024DLX	Dispenser	1	3.95	4.50

## Mity Tape - Duct Tape 50m Length

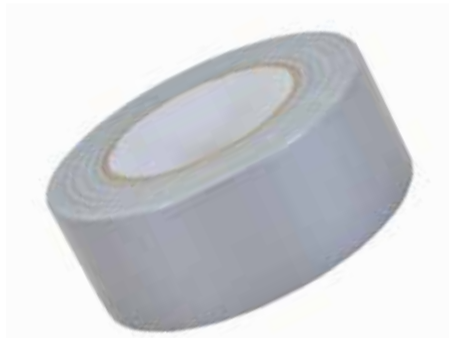

- Top quality cloth with aggressive natural rubber adhesive.
- Tough, durable and waterproof.
- Silver colour.

### 50mm x 50m

CODE	Colour	Unit	6+	1+
MTY505SLV	Silver	1	5.50	5.95

## Masking Tape 50m Length



- Used for masking components during painting and spraying.
- Suitable for joining veneers.

CODE	Size	Unit	36+	12+	1+
MASTP2551	25mm x 50m	1	1.00	1.50	2.00
MASTP3551	50mm x 50m	1	2.25	3.00	3.75

## De-Ionised Water



- Ideal for use in a laser cutter.
- Treated to remove all ions - typically dissolved mineral salts.

CODE	Description	Unit	4+	1+
WAT005DEW	De-Ionised	1	7.75	8.75

## Multi Purpose Filler 1 Litre Tub



- Revolutionary ready-mixed lightweight filler for the preparation of numerous surfaces prior to painting or wallpapering.
- Based on high strength lightweight polymeric fillers.
- Outperforms conventional fillers in most applications
- Designed for professional and DIY use.

CODE	Description	Unit	2+	1+
MPF001TUB	1 litre	1	7.95	8.50

## Hanson Finest Steel Wool



- Manufactured to the finest quality, for surface preparation.
- British made.
- Available in three grades - Fine 0, Extra Fine 00 and Super Fine 0000.
- Supplied in boxes of 225g or 450g.



CODE	Grade	Size	Unit	4+	1+
HAN225FSW	0	225g	1	5.95	6.75
HAN450FSW	0	450g	1	9.95	10.95
HAN225XSW	00	225g	1	6.95	7.95
HAN450XSW	00	450g	1	12.75	13.50

## Wonder Wipes Tub of 100



- Specially formulated to clean hands, tools and surfaces.
- Effective on wet and semi-cured paint, sealant, adhesive, bitumen, expanding foam, oil, grease and even silicone.
- Contains a powerful Anti-Bacterial Additive that is tested by an independent laboratory to BSEN 1276:1997 and BSEN 12054:1995 – the standards for killing bacteria on dirty surfaces and hands.
- Resistant to MRSA, Salmonella, Listeria, E.Coli and Weils Disease. Supplied in a trade tub of 100 wipes.

CODE	Size	Unit	12+	4+	1+
EVE100WWP	Tub of 100	1	7.25	7.75	8.50

## Hanson White Rags 5kg



- Recycled white rags, manufactured from cotton sheeting and shirts.
- Highly absorbent and ideal for polishing and general cleaning tasks.
- Lint-free.



CODE	Size	Unit	2+	1+
HAN005RAG	5kg	1	31.50	33.75

## Hanson Acrylic Sanding Sealer



- A water-based alternative to shellac or cellulose based products.
- Low odour and touch dry in 15 – 20 minutes.
- Apply by brush (standard or foam), cloth or spray gun.
- De-nib with very fine abrasive and apply your final finish.
- Conforms to BS5665 - Safety for Toys, and carries no fire risk



CODE	Size	Unit	2+	1+
HAN001ASS	1 litre	1	15.25	16.75

## Anti-Static Cleaner Spray 750ml



- A 100% solvent-free cleaner ideal for cleaning marks from plastics such as acrylic.
- Gives an anti-static coating to most plastics for up to a month.
- Will not cause stress crazing, even on line bent and flame polished extruded acrylic.

CODE	Description	Unit	4+	1+
ANS750CLN	750ml	1	7.50	7.95

## Tack Cloths Pack of 10



- Ideal for surface preparation and decorating tasks.
- The cloth effectively picks up loose dirt and dust.
- Each cloth is individually foil sealed to ensure cleanliness.

CODE	Size	Unit	2+	1+
HAN010TAC	Pack of 10	1	9.50	10.50

## Shellac Sanding Sealer



- High quality shellac sanding sealer.
- Suitable for use on all woods prior to wax polishing.
- Ideal to seal wood to prevent finger marks or grease entering the grain.



CODE	Size	Unit	2+	1+
HAN500SSS	500ml	1	10.95	11.95

Wood Dye



- This oil based stain is deeply penetrative, quick drying and will not raise the grain - very easy to use.

CODE	Type	Size	Unit	1+
RUS250APN	Antique Pine	250ml	1	6.80
RUS250BMA	Brown Mahogany	250ml	1	6.80
RUS250DOK	Dark Oak	250ml	1	6.80
RUS250EBY	Ebony	250ml	1	6.80
RUS250LOK	Light Oak	250ml	1	6.80
RUS250MOK	Medium Oak	250ml	1	6.80
RUS250WAL	Walnut	250ml	1	6.80
RUS250RMA	Red Mahogany	250ml	1	6.80
RUS1LTAPN	Antique Pine	1 Litre	1	19.95
RUS1LTBMA	Brown Mahogany	1 Litre	1	19.95
RUS1LTDOK	Dark Oak	1 Litre	1	19.95
RUS1LTEBY	Ebony	1 Litre	1	19.95
RUS1LTLOK	Light Oak	1 Litre	1	19.95
RUS1LTMOK	Medium Oak	1 Litre	1	19.95
RUS1LTWAL	Walnut	1 Litre	1	19.95
RUS1LTRMA	Red Mahogany	1 Litre	1	19.95

Premium Wood Filler



- Once dry, the filler leaves a sandable surface, which can be stained, painted, varnished or dyed, even with microporous stains.
- Waterproof when dry and is suitable for exterior as well as interior applications.
- Non flammable and has a low odour.

CODE	Type	Size	Unit	4+	1+
WFL250NAT	Natural	250ml	1	4.50	4.95
WFL250OAK	Oak	250ml	1	4.50	4.95
WFL250MAH	Mahogany	250ml	1	4.50	4.95

2 Part High Performance Wood Filler



- 2 Part High Performance Wood Filler is a fast drying, exterior and interior wood filler.
- Sets hard in approximately 30 mins and may be drilled, carved or planed.
- Natural light wood colour can be painted or stained.

CODE	Size	Unit	4+	1+
EVE500LWF	500g	1	12.95	14.50

Brummer Interior 250g Tin



- Brummer Yellow Label interior grade wood filler which is available in various shades.
- The perfect solution for filling holes and cracks in all types of timber, from fine antiques to modern furniture.
- May be mixed with stain and can be used under nearly all decorative finishes.

CODE	Colour	Size	Unit	6+	1+
BMR250LOK	Light Oak	250g	1	4.95	5.25
BMR250MOK	Medium Oak	250g	1	4.95	5.25
BMR250PNE	Pine	250g	1	4.95	5.25
BMR250WHT	White	250g	1	4.95	5.25

Polyurethane Varnish



- A durable clear varnish with excellent resistance to yellowing.
- Available in gloss or satin finish.

CODE	Type	Size	Unit	1+
RUS500PVG	Gloss Finish	500ml	1	9.95
RUS1LTPVG	Gloss Finish	1 Litre	1	18.75
RUS5LTPVG	Gloss Finish	5 Litres	1	69.95
RUS500PVS	Satin Finish	500ml	1	9.95
RUS1LTPVS	Satin Finish	1 Litre	1	18.75
RUS5LTPVS	Satin Finish	5 Litres	1	69.95

Quick Drying Clear Varnish



- A professional, low solvent varnish that enhances the natural qualities of wood, and provides long lasting protection.
- Developed specifically to give an ultra-hard, scratch resistant and heatproof, non-yellowing finish.
- Waterbased- clean brushes in water.

CODE	Type	Size	Unit	4+	1+
EVE750GLV	Gloss Finish	750ml	1	17.75	19.75
EVE212GLV	Gloss Finish	2.5 Litres	1	54.50	60.25
EVE750SAV	Satin Finish	750ml	1	17.75	19.75
EVE212SAV	Satin Finish	2.5 Litres	1	54.50	60.25
EVE750MTV	Matt Finish	750ml	1	17.75	19.75
EVE212MTV	Matt Finish	2.5 Litres	1	54.50	60.25

Yacht Varnish



- Gloss varnish, based on premium quality resins.
- Provides a tough and flexible finish and its suitable for use on doors, window frames, furniture, floors, even marine application.
- Excellent adhesion and will not flake or peel from the surface when correctly applied.

CODE	Size	Unit	2+	1+
HAN001YAC	1 Litre	1	15.50	16.95
HAN025YAC	2.5 Litre	1	30.25	33.25

MDF Sealer



- A quick drying water based sealer for MDF and also hardboard or wood.
- Provides a perfect clear surface for painting or varnishing - either with oil or water based finishes.
- Provides a greatly enhanced final finish.

CODE	Size	Unit	1+
RUS500MDF	500ml	1	7.50
RUS1LTMDF	1 Litre	1	13.35
RUS212MDF	2.5 Litres	1	29.95

Hanson Premium Danish Oil



- Highly popular natural low lustre finish, based on hard wearing Tung Oil.
- Provides a hard and durable water resistant finish.
- Added resins and driers aid the application.
- Will not craze, peel or chip.



CODE	Size	Unit	2+	1+
HAN500DNO	500ml	1	11.50	12.75
HAN001DNO	1 Litre	1	18.95	21.25
HAN005DNO	5 Litre	1	58.25	64.25

## Chestnut Woodcare Friction Polish



- This polish is for use on lathework and has an above average shellac content to produce an extremely high quality finish.
- Quick drying and environmentally friendly.

CODE	Size	Unit	1+
CWP1LTFRP	1 Litre	1	<b>31.95</b>

## Chestnut Woodcare Lemon Oil



- Lemon Oil gives a virtually matt, non-tacky and water resistant finish to bare timber.
- It enhances the feel of the wood and leaves a pleasant lemon aroma.

CODE	Size	Unit	1+
CWP500LOL	500ml	1	<b>11.95</b>

## Chestnut Woodcare Colour Wood Stains



- A range of quick drying stains for wood that can be intermixed thinned with cellulose thinners.
- These are spirit based so will not raise the grain and can be used to tint the Chestnut cellulose products.

CODE	Colour	Size	Unit	1+
CWP251YLW	Yellow	250ml	1	<b>9.95</b>
CWP252ORG	Orange	250ml	1	<b>9.95</b>
CWP253RED	Red	250ml	1	<b>9.95</b>
CWP254PUR	Purple	250ml	1	<b>9.95</b>
CWP256BLU	Blue	250ml	1	<b>9.95</b>
CWP257GRN	Green	250ml	1	<b>9.95</b>

## Chestnut Woodcare Cellulose Sanding Sealer



- A cellulose based product for use on bare wood prior to applying paste or stick waxes.
- Can be used on lathework or other surfaces.
- Fast drying and low odour.

CODE	Size	Unit	1+
CWP1LTCSS	1 Litre	1	<b>21.95</b>

## Chestnut Woodcare Acrylic Aerosol Lacquer



- A quick drying durable lacquer supplied in an easy to use aerosol, available in gloss or satin.

CODE	Size	Unit	1+
CWP400ALG	Gloss - 400ml	1	<b>8.95</b>
CWP400ALS	Satin - 400ml	1	<b>8.95</b>

## Chestnut Woodcare Acrylic Aerosol Sanding Sealer



- A water-based aerosol sanding sealer to provide a tough base coat for many finishes, particularly wax polishes.

CODE	Size	Unit	1+
CWP400ASL	400ml	1	<b>8.95</b>

## Raw Linseed Oil



- Used for oiling cricket bats and lubricating French polishing rubbers.

CODE	Size	Unit	6+	1+
HAN500RLS	500ml	1	<b>7.50</b>	8.25

## Boiled Linseed Oil



- Traditional oil for finishing hard or close grained timber.
- The Boiled Linseed is faster drying than the raw linseed oil.

CODE	Size	Unit	6+	1+
HAN500BLS	500ml	1	<b>7.25</b>	7.95

## Teak Oil



- Based on special vegetable oils and resins to give a quick drying penetrating seal to teak, cedar and indeed all woods and veneers.

CODE	Size	Unit	6+	1+
HAN500TKO	500ml	1	<b>5.25</b>	5.95

## Methylated Spirits



- Used for thinning French polishes and shellac varnishes.

CODE	Size	Unit	4+	1+
HAN500MTH	500ml	1	<b>3.70</b>	4.10
HAN002MTH	2 Litres	1	<b>12.95</b>	14.50
HAN005MTH	5 Litres	1	<b>26.25</b>	29.25

## Low Odour White Spirit



- Low Odour White Spirit, has a much-reduced odour compared with traditional White Spirit.
- More suited for indoor use and when used in confined spaces.
- The ideal product for paint brush cleaning, general cleaning and degreasing.
- Can also be used as a paint thinner in modern oil/solvent based paints.

CODE	Description	Unit	6+	1+
WHS750LOW	750ml	1	<b>2.50</b>	2.70
WHS002LOW	2 Litre	1	<b>6.25</b>	6.75

## Classic Paste Wax



- Specially formulated clear wax for finishing and enhancing pine and solid wood furniture
- Easy to apply, giving a natural and pleasing look
- Toluene free.

CODE	Size	Unit	2+	1+
HAN450CWX	450ml Clear	1	<b>9.50</b>	10.50
HAN005CWX	5 Litre Clear	1	<b>49.50</b>	54.50

## Cellulose Thinners



- A powerful blend of solvents for any cellulose based finishes.

CODE	Size	Unit	2+	1+
HAN500CLT	500ml	1	<b>8.75</b>	9.75
HAN025CLT	2.5 Litre	1	<b>23.75</b>	26.50

## Genuine Turps BS244



- Traditional thinner for varnishes, artist oils etc.
- Also to dissolve polish components such as beeswax.

CODE	Description	Unit	4+	1+
HAN500TUR	500ml	1	<b>15.50</b>	<b>17.25</b>
HAN002TUR	2 Litre	1	<b>51.25</b>	<b>56.95</b>

## Briwax



- An easy-to-use blend of beeswax and carnauba wax which dries almost instantly and gives excellent results on the lathe or by hand.
- Can be used either on its own or with a sealer. Cleans and polishes.
- Available as original formula or toluene free.

CODE	Type	Size	Unit	6+	1+
BRW400CLO	Original Clear	400g	1	<b>13.50</b>	13.95
BRW5LTCLCLO	Original Clear	5 Litres	1	<b>69.50</b>	72.00
BRW370CLT	Toluene Free Clear	370g	1	<b>13.50</b>	13.95
BRW5LTCLT	Toluene Free Clear	5 Litres	1	<b>69.50</b>	72.00

## White Spirit



- White Spirit is a solvent designed for thinning paints and varnishes, cleaning brushes and general household degreasing and cleaning.
- Conforms to BS245.

CODE	Size	Unit	4+	1+
HAN750WHS	750ml	1	<b>2.30</b>	2.50
HAN002WHS	2 Litres	1	<b>5.50</b>	5.95

## Bio Spirit Water Based Cleaner



- A water-based alternative to White Spirit.
- Ideal product for paint brush cleaning, general cleaning and degreasing.
- Cleans up both wet oil and water based paint.
- Not suitable for paint thinning.

CODE	Description	Unit	6+	1+
BSP750WBS	750ml	1	<b>3.30</b>	3.70

## Natural Creamy Beeswax 250ml



- High quality traditional recipe containing only pure beeswax and genuine turpentine.
- Revives and enriches the natural patina wooden furniture to create a deep rich sheen.
- Suitable for all types of timber.
- Polishes and cleans, leaves a distinctive aroma.

CODE	Size	Unit	2+	1+
HAN250BWX	250ml	1	<b>9.75</b>	10.75

## C4 Sealant Gun



- Sturdy skeleton gun with hexagonal rod, re-enforced ring and hook end.
- Suitable for both C3 and C4 cartridges.

CODE	Description	Unit	12+	6+	1+
EVE0C4SLG	Sealant Gun	1	10.50	11.25	12.50

## General Purpose Silicone



- High modulus silicone sealant that adheres to most smooth and non-porous materials.
- Contains an anti-fungal compound to prevent mould growth in areas of high humidity.
- Forms a permanently flexible rubber seal.
- Supplied in white or clear.

CODE	Description	Unit	12+	4+	1+
EVEGPSWHT	White 280ml	1	3.80	4.10	4.50
EVEGPSCLR	Clear 280ml	1	3.80	4.10	4.50

## Gun-A-Nail Adhesive



- A high strength, gap filling multi-purpose building adhesive based on a solvent free system.
- For use in a wide variety of building and home improvement applications.
- Can be used where at least one of the substrates to be bonded is porous.
- Standard C3 size cartridge 290ml.

CODE	Size	Unit	12+	4+	1+
GAN290WHT	290ml	1	2.05	2.20	2.40

## Brasso



- Traditional liquid metal polish for a fine finish.

CODE	Size	Unit	4+	1+
BSS175MPL	175ml	1	6.50	6.95
BSS100MPL	1 litre	1	18.95	19.95

## Sticky-Off



- Sticky-Off is a sticky adhesive remover ideal for tackling sticky gum, sticky glue, sticky labels, sticky tape and sticky adhesives from surfaces such as glass, plastic, metal, wood, worktops and clothes.
- Simply spray liberally, then allow the Sticky-Off to do the work.
- Pump spray for easy application.

CODE	Description	Size	Unit	1+
RUS060STK	Pump Spray	60ml	1	2.35

## Silicone Spray



- A dry silicone lubricant and mould release agent.
- 100s of uses around the workshop.

CODE	Size	Unit	12+	4+	1+
EVE400SLS	400ml	1	5.95	6.25	6.95

## Concentrated Coolant & Antifreeze - Blue 1 litre



- Associated with Laser Cutters.
- Vital fluid to protects from corrosion, boiling or freezing temperatures, and helps transfer heat.
- Optimum composition of top grade ethylene glycol, combined with treated, de-mineralized water and high-performance additive.

CODE	Size	Unit	6+	1+
AFZ001BLU	1 litre	1	4.95	5.95

## Swarfega Orange Hand Cleaner 450ml or 4 Litre



- An advanced formulation, solvent-free, heavy-duty hand cleaner containing natural cornmeal scrubbers (not plastic microbeads) for a deep down cleaning action and moisturiser to help care for skin.
- Removes ingrained oil, grease and general grime and has a orange/citrus scent.
- The integral pump provides controlled dosages, and prevents the product from cross-contamination. One push is enough for an effective wash.

CODE	Size	Unit	4+	1+
SWF450LPT	450ml	1	10.95	11.95
SWF004LPT	4 Litre	1	29.95	32.95

### SEE WORKPLACE EQUIPMENT

## Deb Skin Safety Centre





## Optima Neat Cutting Fluid



- An effective and competitively priced cutting fluid which is suitable for all metals and processes.
- It has high anti-weld properties, contains extreme pressure additives and is heat stable.
- The fluid can be applied by hand, drip-feed or pumped system.

CODE	Size	Unit	2+	1+
OPT01LNEA	1 Litre	1	11.75	12.95
OPT05LNEA	5 Litre	1	53.50	59.95

## WD40 Smart Straw



- The famous all-purpose lubricant to stop squeaks, free-up rusted components and protect new items.
- Aerosol with integral straw.
- Size 450ml.

CODE	Size	Unit	12+	4+	1+
WDA450SMS	WD40	1	6.50	6.75	7.25

## Rocol Sapphire 2 Bearing Grease



- Triple life bearing grease.
- Pump mounts on top of tank.
- Excellent load carrying and corrosion resistance properties
- Suitable for all types of ball, roller and plain bearings.
- Temperature range: - 30°C to + 150°C.

CODE	Size	Unit	4+	1+
RCL402BGR	400g	1	13.50	14.75

## Optima G Soluble Oil



- A general purpose soluble oil to dilute with water (25:1) and for use on a wide range of machining operations.
- The cooling effect of a flood application makes it ideal for high speed processes.
- Contains corrosion inhibitors.

CODE	Size	Unit	2+	1+
OPT01LSOL	1 Litre	1	10.25	11.50
OPT05LSOL	5 Litres	1	44.50	49.95

## 3-IN-ONE Multi-Purpose Oil



- 3-IN-ONE is a specially formulated lubricating, penetrating and cleaning oil, trusted since 1894.
- Easy-to-use drip spout enables precise application.
- Loosen rusted nuts, bolts, and screws.
- Prevents rust and corrosion.

CODE	Size	Unit	2+	1+
HOW100MPO	100ml	1	2.50	2.75
HOW301MPO	200ml	1	4.50	4.75

## Heavy Duty Grease Gun



- A heavy-duty side lever grease gun that develops up to 10,000psi - 690bar of pressure.
- Aluminium die cast head with an easy locking plunger system and ergonomic pump handle grip.
- Bulk loader system with an air release valve - easy to use.
- 500g (16oz) capacity the gun can be bulk filled by its suction action.
- Will also accept 400g grease cartridges.

CODE	Description	Unit	1+
GGN500SLR	Grease Gun	1	31.50

## Optima G Multi-Purpose Oil



- Quality general purpose oil for lubrication and protection.

CODE	Size	Unit	2+	1+
OPT01LOIL	1 Litre	1	11.50	12.75

## Optima Tapping and Cutting Compound



- A high quality cutting compound for hand application.
- The jelly like consistency adheres to cutting tools.
- Highly recommended for thread cutting operations.

CODE	Size	Unit	2+	1+
OPT500COM	500g	1	19.75	21.95

## Pump Oil Can



- Traditional oil can with lever operated pump.
- Flexible spout.
- ½ pint capacity.

CODE	Description	Unit	10+	4+	1+
POC120FLX	Oil Can	1	4.75	4.95	5.50



# Fixings & Ironmongery

---

**Fixings**  
67-70

---

**Hinges**  
71

---

**Ironmongery**  
72-72

---

**Assortment Boxes**  
72-74

---

**Dowels**  
74

---

**Staplers**  
74

### Assorted Wall Plugs Kit Pack of 220



- Assorted Wall Plugs – 220 piece.
- Qty 75 - 5 x 20mm, Qty 55 - 6 x 22mm, Qty 42 - 7 x 25mm, Qty 35 - 8 x 30mm, Qty 8 - 10 x 60mm, Qty 5 - 12 x 60mm

Code	Description	Unit	1+
ASP220WPL	Wall Plugs	Pack of 220	3.50

### Screw Hook Pack of 10



- Steel with zinc plating for increased corrosion resistance.
- Simply screw directly into timber and similar materials.

CODE	Size	Weight	Unit	4+	1+
FIX558HOK	55mm	8g	Pack of 10	1.10	1.20
FIX812HOK	80mm	12g	Pack of 10	2.15	2.35

### Screw Eye Pack of 10



- Steel with zinc plating for increased corrosion resistance.
- Simply screw directly into timber and similar materials.

CODE	Size	Weight	Unit	4+	1+
FIX254EYE	25mm	4g	Pack of 10	0.90	1.00
FIX408EYE	40mm	8g	Pack of 10	1.05	1.15
FIX512EYE	55mm	12g	Pack of 10	2.00	2.15

### Galvanised Fixing Band



- This Fixing Band is a medium-duty, flexible and strong band which is easy to cut and bend.
- Pre-punched holes for fixing bolts and screws.
- Made from galvanised steel for protection against corrosion.
- Supplied in 12mm wide x 0.7mm thick x 10m roll in a durable cassette.

CODE	Size	Unit	4+	1+
FIX121GFB	12 x 0.7mm x 10m	1 Roll	8.80	9.70

### Hose Clip



- Ideal for hoses, pipes and repairs.
- Non-perforated worm drive with hex and slotted drive.
- Zinc plated mild steel.

CODE	Size	Unit	10+	1+
HSC020ZPL	13-20mm	1	0.75	0.85
HSC025ZPL	18-25mm	1	0.90	1.00
HSC030ZPL	22-30mm	1	0.95	1.05
HSC035ZPL	25-35mm	1	1.00	1.05
HSC045ZPL	32-45mm	1	1.05	1.15
HSC055ZPL	40-55mm	1	1.10	1.20
HSC070ZPL	55-70mm	1	1.30	1.40
HSC090ZPL	70-90mm	1	1.50	1.60
HSC120ZPL	90-120mm	1	1.85	2.05
HSC150ZPL	120-150mm	1	2.15	2.40

### Aluminium Blind Rivets Pack of 100



- Table shows rivet size with grip thickness.

CODE	Size	Grip	Unit	4+	1+
ALR32081K	3.2 x 8mm	2.5-4.5mm	Pack of 100	26.50	29.50
ALR32101K	3.2 x 10mm	4.5-6.5mm	Pack of 100	27.75	30.75
ALR32121K	3.2 x 12mm	6.5-8.5mm	Pack of 100	33.75	37.75
ALR40081K	4 x 8mm	1.5-3.5mm	Pack of 100	31.50	35.00
ALR40101K	4 x 10mm	3.5-5.5mm	Pack of 100	33.25	37.25
ALR40121K	4 x 12mm	5.5-7.5mm	Pack of 100	35.50	40.25

### Hand Riveter



- Well made sturdy tool for all riveting applications.
- Supplied with 4 interchangeable nose pieces to take 3/32", 1/8", 5/32" and 3/16" 4 and 4.8mm rivets.

CODE	Description	Unit	10+	4+	1+
ECL2800HR	Hand Riveter	1	12.25	13.50	15.75

### Lazy Tongs Riveter



- Single push-action pop riveter designed for fast repetitive applications.
- Considerable leverage obtained by the compound action allows steel rivets to be easily set.
- Supplied with 3 nose pieces to take 4.0mm, 4.8mm and 6mm rivets.

CODE	Description	Unit	2+	1+
LZT4486RV	Lazy Tongs Riveter	1	24.50	25.50

### Rivet Set-up and Snap



- This dual function tool is used firstly to set the rivet up and then to form the head.
- Manufactured from heat-treated tool steel.
- Suits rivets with a shank size of 3.2mm / 1/8".

CODE	Size	Unit	4+	1+
RVT300CMB	3 (1/8") x 115mm	1	8.95	9.95

## Veneer Pins 500g Pack



- Bright self-colour finish.

CODE	Size	Unit	10+	4+	1+
VNP15500G	15 x 1.0mm	500g Pack	9.75	10.50	11.75

## Panel Pins 500g or 1 kg Pack



- Bright self-colour finish.

CODE	Size	Unit	10+	4+	1+
PNP155PAK	15 x 1.25mm	500g Pack	5.75	5.95	6.75
PNP205PAK	20 x 1.4mm	500g Pack	4.40	4.70	5.25
PNP255PAK	25 x 1.6mm	500g Pack	4.40	4.70	5.25
PNP25161K	25 x 1.6mm	1kg Pack	8.25	8.95	9.95
PNP30161K	30 x 1.6mm	1kg Pack	7.75	8.25	9.25
PNP40161K	40 x 1.6mm	1kg Pack	7.75	8.25	9.25

## Oval Nails 1kg Pack



- Bright self-colour finish.

CODE	Size	Unit	10+	4+	1+
NAL401OVL	40mm	1kg Pack	7.50	7.95	8.95
NAL501OVL	50mm	1kg Pack	6.95	7.50	8.25

## Round Wire Nails 1kg Pack



- Bright self-colour finish.

CODE	Size	Unit	10+	4+	1+
NAL401RDW	40mm	1kg Pack	6.25	6.75	7.50
NAL501RDW	50mm	1kg Pack	5.75	5.95	6.75
NAL651RDW	65mm	1kg Pack	5.50	5.75	6.50
NAL751RDW	75mm	1kg Pack	4.80	5.25	5.75
NAL101RDW	100mm	1kg Pack	4.80	5.25	5.75

## Black Roundhead Woodscrew Box of 200



- For general applications into softwoods and various types of hardwood with a black passivate finish and pozi-drive head.
- 25° sharp point and single leading thread for a fast start and improved thread acceptance.
- 60° twin-threads with parallel shank for faster insertion and greater pull out resistance.
- Made from C10-18 Steel to ensure consistent quality.

CODE	Size	Unit	5+	1+
BJS316RDH	6 x 5/8"	3.5 x 16 Box of 200	4.70	5.25
BJS320RDH	6 x 3/4"	3.5 x 20 Box of 200	4.90	5.50
BJS325RDH	6 x 1"	3.5 x 25 Box of 200	5.50	6.25
BJS416RDH	8 x 5/8"	4.0 x 16 Box of 200	6.95	7.75
BJS420RDH	8 x 3/4"	4.0 x 20 Box of 200	7.25	8.25
BJS425RDH	8 x 1"	4.0 x 25 Box of 200	7.95	8.95
BJS430RDH	8 x 1 1/4"	4.0 x 30 Box of 200	9.50	10.75
BJS440RDH	8 x 1 1/2"	4.0 x 40 Box of 200	10.50	11.75

## Brass Countersunk Screws Box of 200



- Traditional slotted single thread Wood Screws have countersunk heads.
- Solid brass construction to avoid corrosion.

CODE	Size	Unit	4+	1+
FIX412BCS	4 x 1/2"	Box of 200	7.50	8.25
FIX458BCS	4 x 5/8"	Box of 200	6.50	6.95
FIX434BCS	4 x 3/4"	Box of 200	6.75	7.50
FIX612BCS	6 x 1/2"	Box of 200	7.95	8.95
FIX634BCS	6 x 3/4"	Box of 200	10.50	11.95
FIX610BCS	6 x 1"	Box of 200	13.50	14.95

## Screws Box of 200



- High quality multipurpose wood screws for industrial use, with pozi-drive head.
- Tried and tested to outperform other brands for durability and strength.

CODE	Size	Unit	4+	1+
MPS30012M	3.0 x 12mm	Box of 200	1.50	1.65
MPS30015M	3.0 x 15mm	Box of 200	1.55	1.70
MPS30020M	3.0 x 20mm	Box of 200	1.75	1.95
MPS30025M	3.0 x 25mm	Box of 200	1.95	2.15
MPS30030M	3.0 x 30mm	Box of 200	2.40	2.65
MPS35015M	3.5 x 15mm	Box of 200	1.60	1.75
MPS35020M	3.5 x 20mm	Box of 200	1.70	1.85
MPS35025M	3.5 x 25mm	Box of 200	1.90	2.10
MPS35030M	3.5 x 30mm	Box of 200	1.95	2.15
MPS35035M	3.5 x 35mm	Box of 200	2.25	2.50
MPS35040M	3.5 x 40mm	Box of 200	2.30	2.55
MPS40015M	4.0 x 15mm	Box of 200	1.75	1.95
MPS40020M	4.0 x 20mm	Box of 200	2.15	2.40
MPS40025M	4.0 x 25mm	Box of 200	2.20	2.40
MPS40030M	4.0 x 30mm	Box of 200	2.30	2.50
MPS40035M	4.0 x 35mm	Box of 200	2.35	2.60
MPS40040M	4.0 x 40mm	Box of 200	2.75	2.95
MPS40045M	4.0 x 45mm	Box of 200	2.95	3.25
MPS40050M	4.0 x 50mm	Box of 200	3.50	3.85
MPS40060M	4.0 x 60mm	Box of 200	4.00	4.40
MPS40070M	4.0 x 70mm	Box of 200	4.65	5.15
MPS45030M	4.5 x 30mm	Box of 200	2.60	2.95
MPS45035M	4.5 x 35mm	Box of 200	3.25	3.60
MPS45040M	4.5 x 40mm	Box of 200	3.50	3.80
MPS45050M	4.5 x 50mm	Box of 200	4.95	5.35
MPS50025M	5.0 x 25mm	Box of 200	2.95	3.25
MPS50030M	5.0 x 30mm	Box of 200	3.25	3.60
MPS50035M	5.0 x 35mm	Box of 200	3.55	3.95
MPS50040M	5.0 x 40mm	Box of 200	3.95	4.35
MPS50050M	5.0 x 50mm	Box of 200	5.00	5.50
MPS50060M	5.0 x 60mm	Box of 200	5.95	6.55
MPS50070M	5.0 x 70mm	Box of 200	6.95	7.65
MPS50080M	5.0 x 80mm	Box of 200	7.95	8.75
MPS50100M	5.0 x 100mm	Box of 200	10.25	11.25
MPS60100M	6.0 x 100mm	Box of 200	15.50	16.95

## Workshop Screws Pack of 2000



- Pack contains boxes of 200 screws in the following sizes:
- 3 x 12mm    ● 3.5 x 20mm    ● 4 x 25mm    ● 4 x 40mm
- 3 x 15mm    ● 3.5 x 25mm    ● 4 x 30mm    ● 4 x 45mm
- 4 x 35mm    ● 4 x 50mm

CODE	Description	Unit	1+
RAW201WSP	Workshop Pack	Pack of 2000	24.95

### Dry-Lining Screw Pack of 1000



- 25 degree "Super Sharp" point for ease of penetration, with coarse thread
- Surface hardened up to 750 HV to prevent torque shearing.
- Made from C10-18 Steel.

CODE	Size	Unit	10+	4+	1+
DWS332BLK	3.5 x 32mm	Pack of 1000	13.75	15.25	
DWS342BLK	3.5 x 42mm	Pack of 1000	17.50	19.50	
DWS350BLK	3.5 x 50mm	Pack of 1000	19.95	22.25	

### Plastic Wall Plugs Pack of 1000



- Red (No.10) plug takes Nos. 6-10 (3-4.5mm)screws. Use 5.5mm drill.
- Brown (No.14) plug takes Nos. 0-14 (5-6mm)screws. Use 7.0mm drill.

CODE	Size	Unit	5+	1+
MWPN10PKK	No.10	Pack of 1000	12.50	13.75
MWPN14PKK	No.14	Pack of 1000	15.95	17.75

### Zinc Tool Clips Pack of 25



- Used in a wide variety of applications to either display, hold or store items.
- Bright zinc plated, pack of 25.
- Available in 3 popular sizes.

CODE	Description	Unit	10+	4+	1+
TCL120PAK	Tool Clips 1/2"	Pack of 25	7.50	8.50	9.25
TCL340PAK	Tool Clips 3/4"	Pack of 25	10.50	11.75	12.95
TCL100PAK	Tool Clips 1"	Pack of 25	11.25	12.50	13.95

### Modesty Block White Bag of 100



- Versatile joining blocks, manufactured from durable polyamide.
- Suitable for 6 and 8 gauge (3.5-4.5 mm) screws.

CODE	Description	Unit	10+	4+	1+
MDB168PAK	Modesty Block	Bag of 100	6.95	7.50	8.50

### Machine Screws Pack of 25



- Designed for use with nuts or pre-tapped holes.
- Zinc plated for increased corrosion resistance.
- Pan head with a flat under head surface.
- Threaded the entire length of its shank.
- Cross-recessed drive.

CODE	Size	Unit	4+	1+
FIX420MSP	M4 x 20mm	Pack of 25	1.95	2.25
FIX430MSP	M4 x 30mm	Pack of 25	1.75	1.95
FIX440MSP	M4 x 40mm	Pack of 25	1.85	2.00
FIX512MSP	M5 x 12mm	Pack of 25	1.55	1.70
FIX520MSP	M5 x 20mm	Pack of 25	1.90	2.05
FIX530MSP	M5 X 30mm	Pack of 25	2.25	2.45
FIX540MSP	M5 x 40mm	Pack of 25	2.80	3.05
FIX550MSP	M5 x 50mm	Pack of 25	2.80	3.05
FIX620MSP	M6 x 20mm	Pack of 25	2.50	2.80
FIX630MSP	M6 x 30mm	Pack of 25	3.15	3.45
FIX640MSP	M6 X 40mm	Pack of 25	3.55	3.90
FIX650MSP	M6 x 50mm	Pack of 25	3.70	4.05

### Self-Tapping Screws Box of 200



- Pozidriv self-tapping screws are zinc plated for increased resistance corrosion.
- Pan head with a flat under head surface.
- Screws tap their own thread in a pre-drilled pilot hole, in sheet metal.

CODE	Size	Unit	4+	1+
FIX438ZST	4 x 3/8"	Box of 200	1.95	2.15
FIX412ZST	4 x 1/2"	Box of 200	2.05	2.25
FIX612ZST	6 x 1/2"	Box of 200	2.65	2.90
FIX634ZST	6 x 3/4"	Box of 200	3.20	3.50
FIX858ZST	8 x 5/8"	Box of 200	3.95	4.35
FIX834ZST	8 x 3/4"	Box of 200	4.35	4.75
FIX810ZST	8 x 1"	Box of 200	4.90	5.40

### High Tensile Set Screw Pack of 5 or 10



- Zinc plated Set Screws are made from grade 8.8 steel and are for increased resistance to corrosion.

CODE	Size	Unit	10+	4+	1+
SSC530PAK	M5 x 30mm	Pack of 10	0.70	0.80	0.90
SSC630PAK	M6 x 30mm	Pack of 10	0.95	1.05	1.15
SSC640PAK	M6 x 40mm	Pack of 10	1.05	1.15	1.25
SSC840PAK	M8 x 40mm	Pack of 10	1.85	2.05	2.30
SSC850PAK	M8 x 50mm	Pack of 10	2.25	2.50	2.70
SSC105PAK	M10 x 50mm	Pack of 10	3.20	3.55	3.90
SSC125PAK	M12 x 50mm	Pack of 5	2.60	2.90	3.20

### Hexagon Nut with Nylon Insert ZP Pack of 100

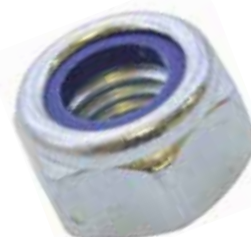

- Nyloc hexagon nut incorporates a nylon component to effectively lock the nut into position.

CODE	Size	Unit	10+	4+	1+
NNY104PAK	M4	Pack of 100	1.95	2.15	2.40
NNY105PAK	M5	Pack of 100	2.15	2.40	2.60
NNY106PAK	M6	Pack of 100	2.95	3.40	3.75
NNY108PAK	M8	Pack of 100	5.75	6.40	7.05
NNY110PAK	M10	Pack of 100	12.25	13.25	14.75
NNY112PAK	M12	Pack of 100	19.50	20.75	23.25

### Hexagon Nut Pack of 50 or 100



- Bright Zinc Plated for increased corrosion resistance.

CODE	Size	Unit	10+	4+	1+
NUT104PAK	M4	Pack of 100	1.15	1.30	1.45
NUT105PAK	M5	Pack of 100	1.60	1.75	1.90
NUT106PAK	M6	Pack of 100	1.95	2.10	2.30
NUT108PAK	M8	Pack of 100	4.05	4.50	4.95
NUT110PAK	M10	Pack of 50	4.20	4.65	5.10
NUT112PAK	M12	Pack of 50	5.95	6.55	7.25

## Wing Nut Pack of 10



- Convenient alternative to the standard Hex Nut, and allow hand tightening.
- Bright zinc plated for increased corrosion resistance.

CODE	Size	Unit	10+	4+	1+
WNT005PAK	M5	Pack of 10	<b>0.95</b>	1.05	1.15
WNT006PAK	M6	Pack of 10	<b>1.00</b>	1.10	1.20
WNT008PAK	M8	Pack of 10	<b>1.25</b>	1.40	1.55
WNT010PAK	M10	Pack of 10	<b>2.00</b>	2.20	2.40
WNT012PAK	M12	Pack of 10	<b>2.95</b>	3.40	3.75

## Pronged T Nuts Pack of 10



- Simple and effective product, offering bolting capability into various soft substrates.
- Zinc Plated for increased resistance to corrosion.

CODE	Size	Unit	10+	4+	1+
PNT016PAK	M6	Pack of 10	<b>1.70</b>	1.90	2.05
PNT018PAK	M8	Pack of 10	<b>1.85</b>	2.05	2.30

## Flat Washer Heavy-Duty Bag of 100



- Heavy-duty Form A Flat Washers
- Bright Zinc Plated and conform to DIN125 standards.

CODE	Size	Unit	10+	4+	1+
WSH104PAK	M4	Bag of 100	<b>0.70</b>	0.80	0.85
WSH105PAK	M5	Bag of 100	<b>0.90</b>	1.00	1.10
WSH106PAK	M6	Bag of 100	<b>1.30</b>	1.45	1.55
WSH108PAK	M8	Bag of 100	<b>2.00</b>	2.20	2.40
WSH110PAK	M10	Bag of 100	<b>3.95</b>	4.35	4.80
WSH112PAK	M12	Bag of 100	<b>6.25</b>	6.95	7.65

## Flat Penny Washer Pack of 10



- These Flat Penny washers, have a 25mm outside diameter
- Bright zinc plated for increased corrosion resistance
- Given the name 'Penny Washer' due to their similarity in size to an old penny.

CODE	Size	Unit	10+	4+	1+
FPW005PAK	M5 x 25mm	Pack of 10	<b>0.70</b>	0.80	0.85
FPW006PAK	M6 x 25mm	Pack of 10	<b>0.70</b>	0.80	0.85
FPW008PAK	M8 x 25mm	Pack of 10	<b>0.70</b>	0.80	0.85
FPW010PAK	M10 x 25mm	Pack of 10	<b>0.70</b>	0.80	0.85
FPW012PAK	M12 x 25mm	Pack of 10	<b>0.70</b>	0.80	0.85

## Spring Washers Pack of 100



- Ring-shaped, split at one point and bent into a helix.
- Prevents loosening of the fastener by either movement or vibration
- Bright zinc plated for increased corrosion resistance.

CODE	Size	Unit	10+	4+	1+
SWH105PAK	M5	Pack of 100	<b>0.70</b>	0.80	0.90
SWH106PAK	M6	Pack of 100	<b>1.35</b>	1.50	1.60
SWH108PAK	M8	Pack of 100	<b>2.50</b>	2.65	2.90
SWH110PAK	M10	Pack of 100	<b>2.75</b>	2.95	3.25
SWH112PAK	M12	Pack of 100	<b>4.50</b>	5.50	5.95

## Threaded Bar-Studding Pack of 10



- 1m fully threaded and conform to DIN 933 standards.
- Bright zinc plated for increased corrosion resistance.

CODE	Size	Unit	4+	1+
STD0M4010	M4 x 1m	Pack of 10	<b>7.75</b>	7.95
STD0M5010	M5 x 1m	Pack of 10	<b>10.75</b>	11.50
STD0M6010	M6 x 1m	Pack of 10	<b>13.25</b>	14.25
STD0M8010	M8 x 1m	Pack of 10	<b>14.75</b>	16.75
STD10010	M10 x 1m	Pack of 10	<b>19.95</b>	22.50
STD12010	M12 x 1m	Pack of 10	<b>28.75</b>	32.75

## Black Cable Ties Pack 100



- Virgin Polyamide (Nylon 6.6) used in production.
- Self extinguishing to UL 94V2.
- Temperature range: -40°C to +80°C.
- Di-electric strength: 50,000V.
- Pack of 100 per sealed poly bag.

CODE	Size	Unit	4+	1+
CTE100BLK	100 x 2.5mm	Pack of 100	<b>1.15</b>	1.30
CTE150BLK	150 x 3.2mm	Pack of 100	<b>1.60</b>	1.80
CTE200BLK	200 x 3.2mm	Pack of 100	<b>2.75</b>	3.25
CTE300BLK	300 x 4.2mm	Pack of 100	<b>4.95</b>	5.75
CTE380BLK	380 x 4.2mm	Pack of 100	<b>5.50</b>	6.25
CTE450BLK	450 x 7.5mm	Pack of 100	<b>8.25</b>	8.75

## Hook and Loop Straps Pack of 10



- A multi-use strap manufactured from a hook and loop material.
- Ideal for securing bundles of wood, metal, cables etc.
- Black nylon.

CODE	Size	Unit	1+
HLS450PAK	25 x 450mm	Pack of 10	<b>3.20</b>

## Polypropylene Rope Pack of 10



- Popular strong blue polypropylene rope.
- Available in 30m coils.

CODE	Size	Unit	5+	1+
PPR103BLU	10mm x 30m Coil	1	<b>17.25</b>	18.95
PPR123BLU	12mm x 30m Coil	1	<b>24.50</b>	26.95

**Piano Hinge**  
Pack of 10



- Electro brass plated.
- Width 25mm x 1830mm length.

CODE	Size	Unit	2+	1+
HNG183PHB	25 x 1830mm	Pack of 10	<b>40.50</b>	44.95

**Corner Bracket**  
Pack of 50



- Self colour, 50mm.

CODE	Size	Unit	4+	1+
CRB050SFC	50mm	Pack of 50	<b>7.25</b>	7.75

**Shelf Brackets**  
Pack of 20



- London pattern.
- White finish.

CODE	Size	Unit	5+	1+
SLF150WHT	150 x 175mm	Pack of 20	<b>12.25</b>	13.50
SLF200WHT	200 x 150mm	Pack of 20	<b>15.25</b>	16.75
SLF250WHT	250 x 200mm	Pack of 20	<b>21.75</b>	23.50

**Steel Hinges**  
Pack of 20 (10 pairs)



- Self-colour steel with fixed pin.

CODE	Size	Unit	4+	1+
HNG038SFC	38mm	Pack of 20	<b>4.50</b>	4.95
HNG050SFC	50mm	Pack of 20	<b>4.60</b>	4.95
HNG063SFC	63mm	Pack of 20	<b>5.25</b>	5.75
HNG075SFC	75mm	Pack of 20	<b>5.50</b>	5.95
HNG100SFC	100mm	Pack of 20	<b>11.95</b>	12.95

**T-Hinge**  
Pack of 20



- Traditional black finish.
- Robust construction.
- Available in 100 or 150mm.

CODE	Size	Unit	5+	1+
HNG100THB	100mm	Pack of 20	<b>6.50</b>	6.95
HNG150THB	150mm	Pack of 20	<b>10.25</b>	11.25

**Tower Bolt 100mm**  
Pack of 10



- Black finish 100mm.

CODE	Size	Unit	5+	1+
TWB100BLK	Tower Bolt	Pack of 10	<b>14.50</b>	15.95

**Bright Zinc Plated Hinges 25mm**  
Pack of 50 (25 Pairs)



- Bright zinc plated steel with fixed pin.

CODE	Size	Unit	4+	1+
HNG025EBP	25mm	Pack of 50	<b>10.75</b>	11.75

**Table Stretcher Plates**  
Pack of 100



- Self Colour, size 38 x 30 x 25mm.

CODE	Size	Unit	4+	1+
STP315SFC	38 x 30 x 25mm	Pack of 100	<b>17.50</b>	18.95

**Yale Nightlatch No.77**



- Original Yale classic design.
- 60mm backset (edge of door to centre of keyhole).
- Electro Nickel Brass finish.

CODE	Size	Unit	5+	1+
NTL060NBR	60mm Backset	1	<b>29.95</b>	32.95

## Mortise Sash Lock 3 Lever



- Lock and unlock from either side.
- Supplied with two keys.
- Nickel plate finish.

CODE	Size	Unit	10+	5+	1+
<b>MSL363PBR</b>	63mm/2.1/2"	1	<b>9.95</b>	10.95	11.95

## Wire Rope



- Galvanised wire rope 7x7 core construction.
- 2mm x 50m.

CODE	Size	Unit	5+	1+
<b>WRP502REL</b>	2mm x 50m Reel	1	<b>15.50</b>	16.95

## Twin-thread Gold Woodscrew - Pack of 780



- Twin-thread Pozzi countersunk screws, yellow zinc passivated for corrosion resistance.
- Includes sizes 3 x 16, 3 x 20, 3.5 x 25, 3.5 x 30, 4 x 30, 4 x 35, 4 x 40, 5 x 40, 5 x 50, 5 x 60 and 5 x 80mm.
- Handy storage case with individual compartments.

CODE	Description	Unit	2+	1+
<b>ASP780WSW</b>	Woodscrews	Pack of 780	<b>13.25</b>	14.25

## Aluminum Lever Lock Handle Set Pair



- Satin finish 150mm.
- Supplied with fixings.
- Supplied as a pair

CODE	Size	Unit	10+	5+	1+
<b>LHS150SET</b>	Satin Finish	1	<b>6.75</b>	7.75	9.00

### SAFETY

## Little Finger Guard



- Little Finger Guard fitted to the front face of a door.
- Opening angle up to 180 degrees.
- Easy to install and clean.
- Supplied with self-adhesive tape to aid fitting.
- Available in Brown or White - please email or phone for pricing.

## Assorted Bolts and Nuts Pack of 240



- Metric hex bolts, nuts and lock washer assortment 240 piece.
- M4, M5, M6, M8 and M10 – various lengths from 12mm to 40mm.
- BZP carbon steel.

Code	Description	Unit	1+
<b>ASP240BNW</b>	Bolts & Nuts	Pack of 240	<b>7.25</b>

## No.3 Internal Door Closure



- A small bodied standard size 3 fire door closer is surface mounted.
- Suitable for right or left hand doors, with fully adjustable hydraulic door speed and latch control.
- An adjustable arm to obtain the correct pressure.
- Maximum recommended door width 950mm, mass 60Kg and max opening angle - 140°.

CODE	Size	Unit	4+	1+
<b>UNN803DCL</b>	Door Closer	1	<b>37.00</b>	45.00

## Nail Assortment Pack 1200 pieces



- A selection of the most popular sizes
- 510 x Zinc Plated Wire Nails: 250 of 1.4 x 20mm, 120 of 1.5 x 25mm, 70 of 1.6 x 30mm, 50 of 2.0 x 40mm and 20 of 3.0 x 75mm.
- 595 x Zinc Plated Wire Brads: 275 of 1.4 x 20mm, 180 of 1.5 x 25mm, 90 of 1.6 x 30mm and 50 of 2.0 x 40mm.
- 95 x Black Panel Pins: 60 of 2.0 x 25mm and 35 of 2.0 x 42mm.

CODE	Description	Unit	1+
<b>ASP1200NL</b>	Nails	Pack of 1200	<b>9.95</b>

## Assorted Machine Screws and Nuts Pack of 285



- Bolt, Nut & Washer Kit contains a 285piece selection of the most popular sizes and is supplied in a handy pack.
- 95 x Zinc Plated Round Head Machine Screws: 20 of 4.0 x 12mm, 18 of 4.0 x 25mm, 18 of 5.0 x 25mm, 12 of 5.0 x 30mm, 12 of 6.0 x 20mm, 9 of 6.0 x 25mm and 6 of 6.0 x 30mm.
- 95 x Zinc Plated Hex Nuts: 38 x 4mm, 30 x 5mm and 27 x 6mm.
- 95 x Zinc Plated Flat Washers: 38 x 4mm, 30 x 5mm and 27 x 6mm.

Code	Description	Unit	1+
<b>ASP285BNW</b>	Machine Screws & Nuts	Pack of 285	<b>11.75</b>



**Cap Head Screws Hex Drive Black - Pack of 106**



- Black phosphate-coated hex drive cap head screws.
- Sizes: M4 x 12mm, M5 x 12mm, M5 x 25mm, M6 x 12mm, M6 x 25mm, M8 x 25mm, M8 x 40mm, M10 x 25mm, M10 x 40mm.

CODE	Description	Unit	1+
ASP106BCS	Cap Head Screws	Pack of 106	7.25

**Hexagon Nuts Pack of 1000**



- Internally threaded fastener.
- Zinc-plated for corrosion resistance.
- Includes sizes M3, M4, M5, M6, M8, M10 and M12.
- Handy storage case with compartments.

CODE	Description	Unit	1+
ASP1000HX	Hexagon Nuts	Pack of 1000	15.75

**Self Tapping Zinc Pan Head Screws Pack of 750**



- Self-tapping PZD pan head screws for multipurpose applications in the home, workshop and garage.
- Zinc-plated for corrosion resistance.
- Assorted sizes: 3/8" x 6, 1/2" x 6, 3/4" x 6, 3/8" x 8, 3/4" x 8, 1" x 8, 1 1/4" x 8, 1/2" x 10, 3/4" x 10, 1" x 10 and 1 1/4" x 10.
- Handy storage case with compartments.

CODE	Description	Unit	1+
ASP750SFT	Zinc Self Tapping	Pack of 750	16.95

**Machine Screws Pack of 450**



- Machine screws for use with nuts or into a threaded hole Zinc-plated for corrosion resistance.
- Assorted sizes: M3 x 8, M4 x 25, M5 x 20, M3 x 12, M3 x 20, M4 x 20, M4 x 40, M5 x 20, M5 x 50, M6 x 30 and M6 x 50.
- Handy storage case with compartments.

CODE	Description	Unit	1+
ASP450MCS	Machine Screws	Pack of 450	13.95

**Lock Nuts Pack of 150**



- Zinc-plated hexagonal steel lock nuts.
- Nylon insert locks nut into place.
- Includes assorted sizes M4-M12.

Code	Description	Unit	1+
ASP146LKN	Lock Nuts	1	13.25

**Self Tapping Stainless Countersink Screws Pack of 570**



- A2 stainless steel self-tapping countersink PZD screws for multipurpose applications in the home, workshop and garage.
- Includes assorted sizes: 3/8" x 4, 1/2" x 4, 3/4" x 4, 1/2" x 6, 3/8" x 6, 3/4" x 6, 1" x 6, 1-1/4" x 6, 1" x 8, 1-1/4" x 8, 1-1/2" x 8.
- Handy storage case with compartments.

CODE	Description	Unit	1+
ASP705SFT	Stainless Self Tapping	Pack of 570	18.50

**High Tensile Bolts Pack of 145**



- High tensile steel BZP hex-head bolts.
- Includes sizes: M5 x 12, M5 x 20, M6 x 30, M6 x 40, M6 x 50, M8 x 30, M8 x 50, M8 x 60, M10 x 30, M10 x 60 and M10 x 70mm.
- Handy storage case with compartments.

CODE	Description	Unit	1+
ASP145HTB	High Tensile Bolts	Pack of 145	14.50

**Standard Spring & Repair Washers Pack of 1000**



- Includes spring washers M6 - M8; penny washers M6 x 25 x 1.3mm and M8 x 30 x 1.6mm; flat washers M3 x 6, M4 x 8, M5 x 10, M6 x 13, M8 x 16, M10 x 20, M12 x 23mm.
- Zinc-plated for corrosion resistance.
- Handy storage case with compartments.

CODE	Description	Unit	1+
ASP1000WS	Washers	Pack of 1000	15.25

**Rivet Pack Pack of 650**



- Aluminium pin and zinc-plated steel rivets.
- Assorted pop rivets. Suitable for joining wood, metal and plastic.
- Includes sizes: 3.2 x 6mm, 3.2 x 8mm, 3.2 x 10mm, 3.2 x 12mm, 4.0 x 6mm, 4.0 x 8mm, 4.0 x 10mm, 4.0 x 12mm, 4.8 x 10mm, 4.8 x 12mm and 4.8 x 14mm.
- Handy storage case with compartments.

CODE	Description	Unit	1+
ASP650RVT	Rivet Pack	Pack of 650	14.95

## Circlips

Pack of 255



- Chemically-blackened steel circlips.
- External for use over shafts. Internal for use inside bores. Allows rotation but prevents lateral movement.
- Includes assorted internal sizes 6 to 23mm and external sizes 7 to 29mm.
- Handy storage case with compartments.

CODE	Description	Unit	4+	1+
ASP255CRC	Circlips	Pack of 255	<b>6.50</b>	

## O - Rings 5 Cross Sections

Pack of 225



- Rubber O rings for sealing gaps between two surfaces. Use to create air and watertight seal between materials or objects.
- Multiple applications from plumbing to watch repair.
- Includes assorted sizes 3 to 22mm.
- Handy storage case with compartments.

CODE	Description	Unit	4+	1+
ASP225RNG	O - Rings	Pack of 225	<b>8.25</b>	

## O - Rings 3 Cross Sections

Pack of 419



- Rubber O rings for sealing gaps between two surfaces. Use to create air and watertight seal between materials or objects.
- Multiple applications from plumbing to watch repair.
- Includes assorted sizes 6 to 58mm.
- Handy storage case with compartments

CODE	Description	Unit	4+	1+
ASP415RNG	O - Rings	Pack of 419	<b>12.50</b>	

## Springs Assortment

Pack of 200



- Can be squashed or stretched, depending on spring type.
- BZP spring steel for corrosion resistance.
- Compression spring sizes  $\frac{3}{32}$  -  $1\frac{1}{2}$ ".
- Extension spring sizes  $\frac{1}{64}$  -  $\frac{1}{64}$ ".
- Handy storage case with compartments.

CODE	Description	Unit	4+	1+
ASP200SPR	Springs Assortment	Pack of 200	<b>9.95</b>	

## Arrow Staple Gun T-50



- Powerful action for heavy gauge staples.
- Jam-proof double lever mechanism.
- Chrome plated steel construction.
- Hardened steelworking parts.

CODE	Description	Unit	4+	1+
ARRT50SPG	Arrow T50 Gun	1	<b>39.95</b>	43.25

CODE	Description	Size	Unit	4+	1+
ARRT50612	Staples	6mm	Pack of 1250	<b>2.50</b>	2.70
ARRT50812	Staples	8mm	Pack of 1250	<b>2.60</b>	2.80
ARRT51012	Staples	10mm	Pack of 1250	<b>2.90</b>	3.10
ARRT51212	Staples	12mm	Pack of 1250	<b>3.10</b>	3.40

## Arrow Staple Gun JT-27



- All metal.
- Ideal for DIY and light industrial use.
- Jam-proof mechanism.

CODE	Description	Unit	4+	1+
ARRJT27SG	Staple Gun	1	<b>15.75</b>	16.95

CODE	Description	Size	Unit	4+	1+
ARRJ2161K	Staples	6mm	Pack of 1000	<b>2.10</b>	2.30
ARRJ2181K	Staples	8mm	Pack of 1000	<b>2.10</b>	2.30

## Jointing Biscuits

Pack of 1000



- Compressed to accurate tolerances allowing controlled expansion in the slot when glued.
- Dimpled surface increases gluing area for maximum strength.
- Available in three sizes: No. 0 (47.5 x 15.5mm), No.10 (53 x 19mm) and No.20 (60 x 23mm) all 4mm thick.

CODE	Description	Unit	4+	1+
JTB001000	No.0	Pack of 1000	<b>39.95</b>	43.25
JTB101000	No.10	Pack of 1000	<b>39.95</b>	43.25
JTB201000	No.20	Pack of 1000	<b>39.95</b>	43.25

## Hardwood Fluted Dowels

Packs of 450, 1000 and 1800



- Precision sized fluted dowels for wood jointing available in three sizes.
- Supplied as a 1kg bag.

CODE	Size	Unit	2+	1+
DOW630FLT	6 x 30mm	Pack of 1800	<b>14.95</b>	15.95
DOW830FLT	8 x 30mm	Pack of 1000	<b>14.95</b>	15.95
DOW140FLT	10 x 40mm	Pack of 450	<b>14.95</b>	15.95

## Dowel Centres

Set of 4 or 12



- Centre Points for accurately aligning dowel holes.
- Available in three sizes.

CODE	Description	Unit	4+	1+
DOW604CNT	Set of 6mm	Pack of 4	<b>2.95</b>	
DOW804CNT	Set of 8mm	Pack of 4	<b>3.25</b>	
DOW104CNT	Set of 10mm	Pack of 4	<b>3.50</b>	
DOW681CNT	Set of 4 x 6, 8, 10mm	Pack of 12	<b>7.95</b>	



# Hand Tools

---

**Measuring and Inspection**  
76-84

---

**Carpentry**  
84-94

---

**Woodcarving**  
94-97

---

**Knives**  
97-99

---

**Files & Rasps**  
100-102

---

**Screwdrivers, Socket Sets & Spanners**  
103-107

---

**Pliers & Metal Cutters**  
107-110

---

**Hammers, Mallets & Punches**  
110-115



## Diatec Outside Micrometer 0-25mm



- Competitively priced precision micrometer.
- Enamelled frame with satin chrome thimble.
- Carbide tipped measuring faces, reading to 0.01mm.
- Measuring capacity of 25mm.

**Diatec**

CODE	Measures	Unit	10+	4+	1+
DIA0250MC	0-25mm	1	17.95	19.50	20.95

## Diatec Inside Micrometer 5-30mm



- Suitable for measuring bores, slots and internal dimensions.
- Capacity: 5-30mm with 0.01mm graduations.
- Satin chrome plated finish with clear graduations.
- Supplied with setting ring gauge.

**Diatec**

CODE	Measures	Unit	1+
DIA530IMC	5-30mm	1	45.00

## Diatec Digital Caliper 300mm/12"



- Versatile precision instrument measuring inside, outside and depth, with a capacity of 300mm/12".
- Large L.C.D. display reads directly in Imperial or Metric.
- Display can be zeroed in any position for tolerance measurements.
- Manufactured from stainless steel.
- Reading to 0.0005"/0.01mm.

**Diatec**

CODE	Measures	Unit	4+	1+
DIA300DCL	300mm/12"	1	65.95	69.95

## Diatec Outside Micrometer 25-50mm



- Competitively priced precision micrometer.
- Enamelled frame with satin chrome thimble.
- Carbide tipped measuring faces, reading to 0.01mm.
- Measuring capacity of 25mm.

**Diatec**

CODE	Measures	Unit	10+	4+	1+
DIA2550MC	25-50mm	1	23.95	25.50	27.95

## Diatec Vernier Caliper 150mm/6"



- Vernier caliper reading to 0.001"/0.02mm.
- Accurate measuring using the outside jaws, inside jaws and depth rod.
- Measuring capacity up to 150mm and 6".

**Diatec**

CODE	Measures	Unit	10+	4+	1+
DIA150VCP	150mm/6"	1	12.95	14.95	15.95

## Diatec Dial Caliper 150mm/6"



- Inside, outside and depth measurement 0-150mm.
- Clear easy to read dimensions (0.02mm increments).
- Made of hardened stainless steel.

**Diatec**

CODE	Measures	Unit	4+	1+
DIA1502DC	150mm/6"	1	33.25	35.50

## Diatec Digital Micrometer 0-25mm



- Highly accurate micrometer measuring to 0.001mm/0.00005".
- All the functions switch between metric and imperial.
- Re-zero, set a datum and more.
- Measuring capacity to 25mm or 1".
- Carbide tipped anvils for durability.

**Diatec**

CODE	Measures	Unit	4+	1+
DIA125DGM	0-25mm/1"	1	59.95	65.00

## Diatec Digital Caliper 150mm/6"



- A versatile precision instrument measuring inside, outside and depth with a capacity of 150mm/6".
- Large L.C.D. display reads directly in Imperial or Metric.
- Display can be zeroed in any position for tolerance measurements.
- Accurate measuring using the outside jaws, inside jaws and depth rod.
- Reading to 0.0005"/0.01mm.
- Manufactured from stainless steel.

**Diatec**

CODE	Measures	Unit	10+	4+	1+
DIA150DCL	150mm/6"	1	25.95	29.95	32.95

## Diatec Black Granite Surface Plates



- Granite is stable and will not distort.
- Supplied in the Workshop Grade 3.
- Highly resistant to wear and will not form a raised burr if damaged.
- Cannot corrode and is resistant to chemicals.

**Diatec**

CODE	Description	Unit	1+
DIA0912GP	9" x 12" x 2"	1	75.00
DIA1812GP	18" x 12" x 3"	1	125.00

## Diatec Vernier Protractor

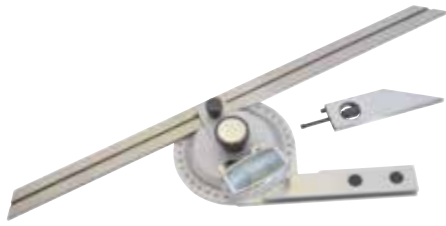

- Made of stainless steel with satin chrome graduations.
- Reading to 5 minutes with magnifier for legibility.
- Supplied with 12° blade and acute angle measuring attachment.

**Diatec**

CODE	Description	Unit	1+
DIA300VPR	Vernier Protractor	1	49.95

## Diatec Vernier Height Gauge



- Measuring slides made of hardened steel with a capacity of 300mm/12".
- Satin chrome finish with etched graduations and magnifier.
- Sliding main scale with fine adjustment for exact reading to 0.001"/0.02mm.
- Tungsten carbide tipped scriber.

**Diatec**

CODE	Measures	Unit	1+
DIA120VHG	300mm/12"	1	125.00

## Diatec Digital Gauge



- Digital version of the Diatec Dial Gauge with plunger action and plain back mounting.
- Measures in both metric and Imperial 10mm <sup>3</sup>/<sub>8</sub>", with a zero reset button.
- 0.01mm/0.0005" reading.

**Diatec**

CODE	Measures	Unit	4+	1+
DIA2010DT	10mm / <sup>3</sup> / <sub>8</sub> "	1	37.50	39.50

## Diatec Mini Digital Height Gauge



- Stainless steel stem has a measuring range of 150mm/6" and is mounted in a heavy steel base.
- Extra large LCD screen displays in three modes: metric (0.01mm increments) and imperial in both decimal (0.0005" increments) and fractional (<sup>1</sup>/<sub>64</sub>" increments).
- Zero setting for comparative measuring.

**Diatec**

CODE	Measures	Unit	1+
DIA150DHG	150mm/6"	1	69.50

## Diatec Magnetic Base



- Heavy duty model with fine adjustment and chromed rods.
- Magnetised surfaces – vee base and rear.
- Base size: 2 1/2" x 2 1/4" x 2" (63mm x 56mm x 50mm).

**Diatec**

CODE	Description	Unit	4+	1+
DIA0341MB	Magnetic Base	1	16.95	17.95

## Diatec Dial Test Indicator Metric



- Indicator type with swivelling stylus.
- Two mounting spigots held on dovetail slides.
- Automatic reversal, measures in metric 0-0.8mm in both directions.
- 30mm face diameter.
- 0.01mm graduations.

**Diatec**

CODE	Measures	Unit	4+	1+
DIA4710DI	0-0.8mm	1	39.95	45.00

## Diatec Digital Height Gauge



- Precision height gauge manufactured from stainless steel with a capacity of 300mm/12".
- Large, clear LCD display to 0.0005"/0.01mm.
- Instant Imperial and Metric conversion.
- Relative and absolute modes with preset functions.
- Tungsten carbide tipped scriber.

**Diatec**

CODE	Measures	Unit	1+
DIA300DHG	300mm/12"	1	195.00

## Diatec Dial Gauge Metric



- Plunger type with lug back mounting.
- Revolution counter and tolerance pointers (measures in metric).
- 58mm face diameter.
- 0.01mm reading.
- Measures 0-10mm in 0.01mm increments.

**Diatec**

CODE	Range	Unit	4+	1+
DIA4070DG	10mm	1	22.75	23.95

## Diatec Feeler Gauges Metric



- Metric 20 blade feeler gauge measuring from 0.05 to 1mm.

**Diatec**

CODE	Measures	Unit	4+	1+
DIA20MFGA	0.05 - 1mm	1	4.75	4.95

## Diatec Radius Gauge



- Both internal and external radii from 1mm to 7mm
- Penknife style holder with 32 blades.

**Diatec**

CODE	Range	Unit	4+	1+
DIA107RDG	1mm to 7mm	1	10.50	11.75

## Diatec Screw Cutting Gauge



- For grinding and setting up single point threading tools.
- Includes 60 degrees for UN and Metric, 55 degrees for BSW/BSF, 47½ degrees for BA and 14½ degrees for Acme.

**Diatec**

CODE	Description	Unit	1+
DIA4714CG	Screw Cutting Gauge	1	7.95

## Diatec Universal Surface Gauges



- Hardened steel base and scriber, 300mm/12" height.
- Fine pitch screw allows minute adjustments.
- Retractable gauge pins for linear work.
- Vee groove in base for use on round surfaces.
- Approximate base dimensions 3½" x 2½".

**Diatec**

CODE	Description	Unit	1+
DIA300SG9	300mm/12"	1	32.95

## Diatec Depth Gauge Protractor



- Graduated in degrees and reading in both directions.
- 6"/150mm rule graduated in 64ths of an inch and 0.5mm.
- Depth measuring rod will fit 3/16" diameter holes.

**Diatec**

CODE	Description	Unit	4+	1+
DIA150DGP	Depth Gauge Protractor	1	9.95	10.95

## Diatec Screw Pitch Gauge



- Covers both metric 60 degree and Whitworth 55 degree screw threads.
- 52 blades, ranging from 4 to 62 tpi and 6 to 0.25mm.

**Diatec**

CODE	Description	Unit	4+	1+
DIA052SPG	Screw Pitch Gauge	1	8.95	9.50

## Trammel Heads



- For marking or scribing arcs and circles beyond the capacity of dividers.
- All metal construction with a pencil clamp facility.
- Clamps onto beam thicknesses of 30mm maximum.

CODE	Description	Unit	4+	1+
TMH030SET	Trammel Heads	1	18.95	19.75

## Diatec Workshop Engineers' Square



- Precision all metal squares.
- Ground on both edges of the blade and stock.
- Manufactured to workshop grade.

**Diatec**

CODE	Size	Unit	10+	4+	1+
DIA4104SQ	4"/100mm	1	6.50	6.95	7.50
DIA4106SQ	6"/150mm	1	8.95	9.75	10.50

## Diatec Pro Squares



- Precision all metal squares.
- Ground on both edges of the blade and stock.
- Manufactured to workshop grade.
- Diatec Pro squares are made to B.S. 939, grade B for squareness and straightness.

**Diatec**

CODE	Size	Unit	4+	1+
DPR4102SQ	2"/50mm	1	7.95	8.95
DPR4103SQ	3"/75mm	1	9.25	10.25
DPR4104SQ	4"/100mm	1	10.95	11.75
DPR4106SQ	6"/150mm	1	13.50	14.95
DPR4109SQ	9"/225mm	1	29.50	33.95

## Pencil Compass



- Large well made compass and divider.
- Tight fitting pivot joint and a positive locking clamp operating on a quadrant.
- Leg length: 250mm.
- Pencil not supplied.

CODE	Size	Unit	1+
PNC250MMB	250mm	1	19.95

## Diatec Jenny Caliper



- Premium calipers manufactured and finished to a high standard.
- Fitted with solid adjusting nut.
- Special alloy steel springs for a smooth, precise action.



CODE	Description	Size	Unit	4+	1+
DPR125JCL	Jenny Caliper	5"	1	8.50	8.95

## Diatec 4" Divider



- Premium dividers manufactured and finished to a high standard.
- Fitted with solid adjusting nut.
- Special alloy steel springs for a smooth, precise action.



CODE	Description	Size	Unit	4+	1+
DPR100DIV	Dividers	100mm	1	8.50	9.50

## Scriber Single Ended



- Hardened and tempered steel point.
- Knurled grip.
- 125mm/5".

CODE	Length	Unit	20+	10+	1+
SCR125SED	5"	1	1.75	2.00	2.25

## Scriber Double Ended



- Hardened and tempered straight and cranked steel points.
- Knurled grip.
- 200mm/8".

CODE	Length	Unit	20+	10+	1+
SCR200DED	8"	1	2.25	3.00	3.25

## Diatec Dividers and Calipers Premium Grade



- Premium dividers and calipers manufactured and finished to a high standard.
- Fitted with solid adjusting nut.
- Special alloy steel springs for a smooth, precise action.



CODE	Description	Size	Unit	4+	1+
DPR150OCL	Outside Caliper	150mm	1	8.95	9.95
DPR150ICL	Inside Caliper	150mm	1	8.95	9.95
DPR150DIV	6" Dividers	150mm	1	8.95	9.95

## Diatec Dividers and Calipers Workshop Grade



- Good quality workshop grade, all steel products.
- Spring style with a solid nut.



CODE	Description	Size	Unit	10+	4+	1+
DIA150OCL	Outside Caliper	150mm	1	5.95	6.50	6.95
DIA150ICL	Inside Caliper	150mm	1	5.95	6.50	6.95
DIA150DIV	Dividers	150mm	1	5.95	6.50	6.95

## Scriber Carbide Tipped



- Inserted carbide point.
- Handy pocket clip.

CODE	Length	Unit	20+	10+	1+
SCR150CAR	6"	1	3.75	4.25	4.75

### SEE CUTTING TOOLS

## Drills, Taps and Dies



## Diatec Pro Combination Square



- Heavy duty die cast stock and etched blade.
- Machined stainless steel blade.
- Fitted with scriber and spirit level.
- Blade length 12"/300mm.

**Diatec**

CODE	Description	Unit	10+	5+	1+
DIA312PCS	Diatec Pro	1	12.95	13.95	14.95

## Diatec Combination Set 4 Piece

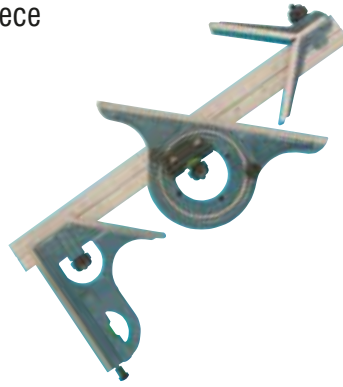

- Popular engineering grade combination set.
- Comprising a 300mm rule plus a square, centre and protractor head.
- Heavy duty cast iron heads.
- Satin chrome rule with etched markings.

**Diatec**

CODE	Description	Unit	4+	1+
DIA300CBS	Comb. Set	4 Piece	55.00	59.50

## Stanley Chalk Line



- Shatterproof polypropylene case with 30m/100ft line.
- High speed rewind 3.5 : 1 geared.
- Stainless steel hook and metal crank arm.

CODE	Length	Unit	4+	1+
STA047460	30m/100ft	1	11.95	12.95

## Cast Iron Combination Square



- Heavy duty combination square with a cast iron stock and an etched blade.
- Fitted with spirit level and removable scriber.
- Blade length 12"/300mm.

CODE	Description	Unit	4+	1+
FIS1953ME	Cast Iron	1	22.50	24.25

## OX Pro Level



- The strongest level EVER or your money back!.
- Unique dual view.
- Silicone air cushioned handles.
- Shock proof end caps.
- Available in 600, 900 and 1200mm.

CODE	Description	Unit	12+	4+	1+
OXT060PRL	600mm	1	40.50	42.25	45.75
OXT090PRL	900mm	1	49.75	52.25	56.50
OXT120PRL	1200mm	1	54.50	57.25	61.75

## Chalk Refills



- Fine high quality chalk.
- 225g/8oz container.
- Colour blue.
- Specially formulated for good adhesion and high visibility when marking out.

CODE	Description	Unit	4+	1+
CKR80ZBLU	Chalk Refills	1	4.90	5.25

## Stanley Combination Square



- Precision die cast body has three machined faces.
- Can be used as a try and mitre square, depth and height gauge and spirit level.
- The sliding 300mm/12" rule is etched and coated for rust resistance.

CODE	Description	Unit	4+	1+
STA046028	Comb. Square	1	25.95	28.25

## Die-Cast Combination Set



- Die-cast square, centre and protractor head.
- 12"/300mm graduated blade.

CODE	Description	Unit	4+	1+
CBS300012	Die-Cast	1	13.95	15.25

## OX Trade Level

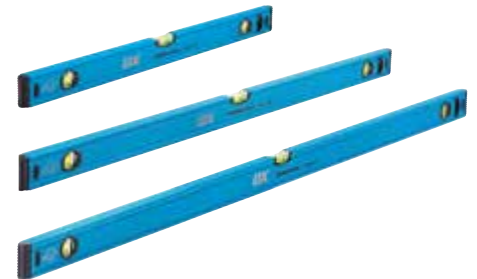

- Strong, lightweight aluminium profile with a lifetime vial warranty.
- 3 solid acrylic UV resistant vials with accuracy of 0.5mm/m.
- Milled surface on base.
- Shock absorbing rubber end caps.
- Available in 600, 900 and 1200mm.

CODE	Description	Unit	12+	4+	1+
OXT060TLV	600mm	1	21.25	22.25	23.95
OXT090TLV	900mm	1	25.95	27.25	29.50
OXT120TLV	1200mm	1	30.25	31.75	34.25



## Basic Boat Spirit Level



- Strong aluminium construction.
- Vertical and horizontal vials.

CODE	Description	Unit	4+	1+
LEV025ALU	250mm Level	1	<b>6.95</b>	7.75

## Basic Spirit Level



- Strong aluminium construction.
- Vertical and horizontal vials.

CODE	Description	Unit	4+	1+
LEV060ALU	600mm Level	1	<b>9.75</b>	10.50
LEV090ALU	900mm Level	1	<b>10.50</b>	11.25
LEV120ALU	1200mm Level	1	<b>13.75</b>	14.95

## Stabila 70T Torpedo Spirit Level



- Sturdy level with two shockproof vials (one horizontal and one vertical).
- Epoxy locked top frame and a lasting accuracy of 0.029° = 0.5mm/m in vial up position.

CODE	Length	Unit	4+	1+
STB702010	10"/250mm	1	<b>9.75</b>	10.50

## Stabila 70-2 Series Spirit Levels



- Strong smooth aluminium box section.
- 3 vials: 2 plumb and 1 horizontal.
- Accuracy 0.029° = 0.5mm/m.
- Electrostatic powder coating.

CODE	Length	Unit	4+	1+
STB702024	24"/600mm	1	<b>14.95</b>	15.75
STB702036	36"/900mm	1	<b>17.95</b>	18.75
STB702048	48"/1200mm	1	<b>22.25</b>	23.25

## Stabila 96-2 Series Spirit Levels



- An extra strong aluminium box section ribbed body.
- Fitted with three vials and with two milled faces (except 72"/1.8m).
- Rubberised end cap to prevent slipping when marking on walls.
- Permanently bonded unbreakable acrylic vials.
- Built-in accuracy to 0.5mm per metre in normal position.
- Can also be used in vial down position.

CODE	Length	Unit	4+	1+
STB962024	24"/600mm	1	<b>35.25</b>	36.95
STB962032	32"/800mm	1	<b>40.95</b>	42.95
STB962040	40"/1000mm	1	<b>51.75</b>	54.25
STB962048	48"/1200mm	1	<b>62.95</b>	65.95
STB962072	72"/1800mm	1	<b>74.25</b>	77.75

## Stabila 83 S Series Spirit Levels



- Pressure die-cast frame and milled measuring faces.
- 0.5mm accuracy to be obtained in both vial positions.
- Fitted with three vials with windows for all round viewing.
- Permanently bonded unbreakable acrylic vials.

CODE	Length	Unit	4+	1+
STB83S024	24"/600 mm	1	<b>65.75</b>	68.95
STB83S032	32"/800 mm	1	<b>73.95</b>	77.50
STB83S040	40"/1000 mm	1	<b>88.95</b>	93.25

## Stabila 81 S Series Spirit Levels



- Professional torpedo level with pressure die-cast frame and one milled measuring face.
- Two vials for vertical and horizontal use.
- Also available with a magnetic base.
- Permanently bonded unbreakable acrylic vials.
- Built-in accuracy to 0.5mm per metre in normal position.
- Can also be used in vial down position.

CODE	Length	Unit	4+	1+
STB81S010	10"/250mm	1	<b>29.75</b>	31.75
STB81SM10	10"/250mm Magnetic	1	<b>27.50</b>	28.75

## Stanley FatMax Torpedo Level



- 3 Vials and is 220mm in length.
- Die-cast aluminium body, solid block vials and rare earth magnets.
- Pipe groove allows it to be used on rounded surfaces
- 5 year accuracy guarantee.

CODE	Length	Unit	4+	1+
STA022FML	220mm Level	1	<b>22.25</b>	23.95

## Stanley FatMax Spirit Levels



- Heavy-duty box levels, machine milled on two sides to ensure accuracy.
- Large centre vial is bridged to allow a continuous line to be marked on the work piece.
- Shock absorbing end caps for longer life.
- Accuracy of ±0.5mm/m on one face and ±0.7mm/m on the other, and covered by a 5 year accuracy guarantee.

CODE	Length	Unit	4+	1+
STA060FML	600mm Level	1	<b>30.25</b>	32.75
STA090FML	900mm Level	1	<b>36.25</b>	39.25
STA120FML	1200mm Level	1	<b>42.25</b>	45.75
STA180FML	1800mm Level	1	<b>72.50</b>	78.50

## Stabila 80 AS-2 Spirit Level 1200mm



- Fitted with two vertical and one horizontal high-quality vials with precision-ground inner contours and fluorescent liquid.
- Electrostatic powder coated aluminium profile with reinforcing ribs for high stability and a secure grip.
- Anti-slip stoppers that prevent the level from moving when held against a wall.
- Measuring accuracy of  $\pm 0.5$  mm/m in a normal position and  $\pm 0.75$  mm/m in reverse position.

CODE	Description	Unit	40+	30+	1+
STB060ASD	600mm/24"	1	25.95	26.75	27.95
STB120ASD	1200mm/48"	1	33.95	34.95	36.95

## Stabila LAR 160 Rotation Laser 7 Piece Set



- Fully automatic, motor-driven rotation laser – high levelling accuracy of  $\pm 0.1$  mm/m, fast self-levelling function.
- Horizontal and vertical rotation, plumb-line function and right angle (90°) in vertical operation.
- Protection class IP 65 – dustproof and waterproof.
- Set comprises: laser, receiver, tripod, levelling rod, goggles, target plate, carrying case, and batteries.

CODE	Description	Unit	1+
STB160SET	LAR 160	1	750.00

## Dewalt DW088K Line Laser



- Self-levelling cross line laser is accurate to  $\pm 0.3$  mm/m in levelling applications.
- Built in magnetic pivot bracket mounts easily on metal surfaces.
- Over-molded housing and thick glass protects the tool and maintains calibration.
- Includes a heavy duty carrying case, wall mount bracket and 3 x AA batteries.

CODE	Description	Unit	1+
DEW088LLS	Dewalt Line Laser Set	1	159.50

## Long Tape Measure 20m/66'



- Tough ABS case.
- Flush winding handle.
- Metric and inch graduations - 20m/66'.

CODE	Description	Unit	6+	1+
LTM020ABS	20m/66'	1	7.95	8.95

## Pro Long Tape Measure 30m/100'



- Impact resistant ABS case with soft TPR grip.
- Geared 4:1 rewind.
- Fibreglass tape with PVC coating.
- Metric and inch graduations - 30m/100'.

CODE	Description	Unit	6+	1+
LTM030PRO	30m/100'	1	11.95	12.95

## Diatec Contractor Tape Measures



- Bi-material soft grip body.
- Sturdy belt clip.
- Clear Metric and Imperial graduations.
- Blade is lockable in any position.

CODE	Description	Length	Unit	10+	4+	1+
TPM03M10F	Contractor Tape	3m/10ft	1	1.75	2.50	
TPM05M16F	Contractor Tape	5m/16ft	1	2.75	2.95	3.50

## OX Trade Tape Measure 5m



- Duragrip moulded rubber case.
- Nylon coated steel blade - 25mm wide.
- Shock absorbing blade return bumper.
- Easy slide thumb lock.
- 5m metric only.

CODE	Description	Unit	12+	4+	1+
OXT500TPM	5m Metric	1	3.50	3.60	3.95

## Stanley FatMax Tape



- BladeArmor Tape has a Mylar coated steel blade with both metric and imperial graduations.
- An impressive 32mm wide blade with a stand out of 3.35 metres.
- High-impact ABS plastic case has an over sized rubberised bumper, to prolong the life of the hook.
- Accurate 3-rivet, corrosion resistant, tru-zero hook featuring top, bottom and side hooks for all round measurements.

CODE	Description	Length	Unit	6+	1+
STA033719	Fat Max	5m/16ft	1	21.75	23.50
STA033726	Fat Max	8m/26ft	1	26.50	28.75

## Stanley Powerlock Tape



- Mylar coated steel blade with metric and imperial graduations which is 10 times more resistant to abrasion.
- Super-strong 3 rivet, automatically adjustable tru-zero end hook.
- High-impact, chrome plated ABS plastic case.
- Auto-locking mechanism and a conventional steel belt clip.

CODE	Description	Length	Unit	6+	1+
STA033523	Powerlock	3m/10ft	1	7.75	8.50
STA033553	Powerlock	5m/16ft	1	13.75	14.75
STA033526	Powerlock	8m/26ft	1	17.95	19.50

## Stanley Tylon Tape



- Corrosion resistant, long life Tylon™ coated blade with positive blade lock for accurate measurements.
- Both metric and imperial graduations.
- Tru-zero hook, that compensates accurately for internal and external measurements, with triple rivet construction.
- Impact resistant ABS plastic case is fitted with an ergonomic over mould.

CODE	Description	Length	Unit	6+	1+
STA130686	Tylon Tape	3m/10ft	1	4.20	4.50
STA130696	Tylon Tape	5m/16ft	1	6.50	6.95
STA130656	Tylon Tape	8m/26ft	1	12.50	13.50

## Pro Tape Measure



- Impact resistant ABS case with soft TPR grip.
- Metric and inch graduations.
- Steel blade nylon coated both sides.

CODE	Size	Unit	12+	6+	1+
TPM310PRO	3m/10'	1	2.50	3.00	3.25
TPM516PRO	5m/16'	1	4.75	5.50	6.25
TPM826PRO	8m/26'	1	7.00	7.75	8.95

## Aluminium Scale Rule



- Triangular aluminium scale rule printed with six different metric scales : 1:20, 1:25, 1:50, 1:75, 1:100 and 1:125.
- Length of scale 300mm.

CODE	Description	Length	Unit	10+	4+	1+
ASR012300	Scale Rule	300mm	1	3.95	4.30	4.95

## Diatec Folding Steel Rule



- Two 300mm sections fold out to 600mm.
- Rust resistant stainless steel with added scale.
- Engraved metric scale.

CODE	Description	Length	Unit	10+	5+	1+
DIA600FSR	Folding Steel Rule	600mm	1	7.25	8.25	9.50

## Diatec Safety Rule



- Acts as a hand guard when used with a knife.
- Made from heavy gauge stainless steel with a hanging hole.
- Grips surface firmer than conventional rule or straight edge.
- Metric graduations: cm/mm.
- Available in either 300mm or 450mm.

CODE	Description	Length	Unit	20+	10+	1+
DIA300SFR	Safety Rule	300mm	1	2.25	2.75	3.00
DIA450SFR	Safety Rule	450mm	1	3.95	4.50	4.95

## Diatec Metric Stainless Steel Rule



- Clear metric engraved graduations.
- Manufactured from stainless steel.
- Double sided with scale on all four edges.

CODE	Description	Length	Unit	20+	10+	1+
RUL150MET	Steel Rule	150mm	1	1.25	1.75	1.95
RUL300MET	Steel Rule	300mm	1	1.95	2.25	2.50
RUL600MET	Steel Rule	600mm	1	6.95	7.50	7.95
RUL001MET	Steel Rule	1000mm	1	9.95	10.95	11.95

## Diatec Metric/Imperial Stainless Steel Rules



- Easy to read satin chrome finish.
- Made from stainless steel.
- Metric and Imperial graduations on one side and Imperial on the reverse, (except the 40"/1m which has conversion tables on the reverse).

CODE	Length	Unit	20+	10+	1+
RUL006DUL	6"/150mm	1	1.75	1.95	2.15
RUL012DUL	12"/300mm	1	2.50	2.75	2.85
RUL024DUL	24"/600mm	1	7.95	8.50	8.95
RUL036DUL	40"/1000mm	1	10.50	11.50	12.50

## Precision Stainless Steel Rules



- Made from fully heat treated stainless steel.
- Satin chrome non-glare finish with etched graduations.
- Metric graduations on one side and Imperial on the reverse.

CODE	Length	Unit	4+	1+
FIS0150SR	150mm/6"	1	4.80	5.25
FIS0300SR	300mm/12"	1	8.95	9.75
FIS0600SR	600mm/24"	1	21.75	23.75
FIS1000SR	1000mm/36"	1	41.25	44.95

## Steel Straight Edge 24"



- Ground steel 600mm/24" straight edge.
- Section size 32mm x 6.5mm.
- Accuracy of 0.001" tolerance.

CODE	Length	Unit	4+	1+
STE240STL	24" Edge	1	27.95	29.95

## Folding ABS Rule



- Virtually unbreakable white ABS plastic with bevelled edges.
- 1m metric scale: graduated in 1, 5 and 10mm.
- 39" Imperial scale: graduated in 8ths, figured every inch.

CODE	Length	Unit	4+	1+
RUL139FDR	1m/39"	1	6.95	7.50

## Edding Marking Blue Pen



- Giant felt marker with a stroke width of 18mm.
- Ideal for use instead of marking blue on layout work.
- Easily applied and gives rapid coverage without mess and wastage.
- Refill ink is available in 100ml bottles.

CODE	Description	Unit	4+	1+
EDD850MBP	Pen	1	10.25	11.50

## Stanley Adjustable Quick Square



- Multipurpose square with an adjustable arm that can be used as a saw guide, bevel or protractor.
- Heavy-duty 170mm aluminium construction for durability
- Black body with permanent yellow graduations provides maximum readability.
- Features Common, Jack, Hip and Valley scales.

CODE	Description	Size	Unit	4+	1+
STA146053	Quick Square	170mm	1	24.95	26.95

## Marking Blue



- The well known marking blue for gauging, finishing and scraping operations.
- Supplied in small tin.

CODE	Size	Unit	1+
STU38GMMB	38g Tin	1	6.50

## Edding Marking Blue Refill



- Refill ink for Edding Marking Blue Pen .
- 100ml bottle

CODE	Description	Unit	1+
EDD100REF	100ml Refill Bottle	1	13.50

## Preston Square Beech



- Beech stock with brass face and rivets .
- Blued steel blade measuring 150mm/6" to the brass face.
- Overall length 198mm.

CODE	Description	Unit	2+	1+
PST600BSQ	150mm/6"	1	5.95	7.80

## Marking Blue Fluid



- Traditional marking fluid in transparent blue colour.
- 1 litre bottle.

CODE	Size	Unit	1+
MFD100TBL	1 Litre	1	35.95

## OX Trade Carpenter's Pencils Hard or Medium Pack of 10 with Sharpener



- 10 Carpenters pencils with FREE sharpener included.
- Comfort grip and easy to hold.
- Body colour - hard/green or medium/red.

CODE	Description	Unit	12+	4+	1+
OXT102PHD	Hard	Pack of 10	5.50	5.75	6.25
OXT101PME	Medium	Pack of 10	5.50	5.75	6.25

## Preston Sliding Bevel Beech



- Beech stock with brass side plates.
- Blued steel blade measuring 190mm/7.5".
- Wing nut clamp.

CODE	Description	Unit	2+	1+
PST750BEV	190mm/7.5"	1	6.95	8.95

**J. Marples  
Beech Squares**



- Made from solid beech and brass.
- Squares are brass faced and have three rivets for rigidity.
- Squares comply with BS3322 and blued spring-steel blades.
- Made in Sheffield by Joseph Marples.

CODE	Size	Unit	10+	4+	1+
JML200S06	6"	1	<b>8.25</b>	9.25	9.50
JML201S09	9"	1	<b>9.50</b>	10.50	10.75

**J. Marples  
Mitre Square**



- 45 degree square, accuracy exceeds BS3322.
- Rosewood stock.
- Tempered steel blade.
- Made in Sheffield by Joseph Marples.

CODE	Size	Unit	4+	1+
JML19VMS9	9"	1	<b>17.50</b>	19.25

**J. Marples  
Sliding Bevel  
Beech**



- Wing nut.
- Tempered steel blade.
- Beech stock.
- Made in Sheffield by Joseph Marples.

CODE	Size	Unit	10+	4+	1+
JML750BEV	7½"	1	<b>9.25</b>	10.25	10.50
JML900BEV	9"	1	<b>9.50</b>	10.50	11.00

**J Marples  
Walnut Try Square**



- Made in Sheffield, accuracy exceeds BS3322.
- Walnut stock with brass rivets and wear plates.
- Tempered steel blades.

CODE	Size	Unit	10+	4+	1+
JML906WSQ	6"	1	<b>12.95</b>	13.75	15.25
JML909WSQ	9"	1	<b>14.95</b>	15.95	17.50
JML912WSQ	12"	1	<b>19.95</b>	21.25	23.25

**J Marples  
Walnut Mitre Square**



- 45 degree square with accuracy exceeding BS3322.
- Walnut stock.
- Tempered steel blade.
- Size: 9".

CODE	Size	Unit	6+	1+
JML900WMS	9"	1	<b>15.50</b>	16.95

**J Marples  
Sliding Bevel  
Walnut**



- Walnut stock with brass wear plates.
- Knurled locking nut.
- Tempered steel blades.
- Size: 7½" or Size: 9".

CODE	Size	Unit	10+	4+	1+
JML750WBV	7½"	1	<b>14.25</b>	14.95	16.50
JML900WBV	9"	1	<b>16.75</b>	17.75	19.50

**J. Marples  
Rosewood Try Square**



- Accuracy exceeds BS3322.
- Rosewood stock.
- Brass rivets and wear plates.
- Tempered steel blades.
- Made in Sheffield by Joseph Marples.

CODE	Size	Unit	10+	4+	1+
JML19DS06	6"	1	<b>13.50</b>	14.25	15.25
JML19ES09	9"	1	<b>18.75</b>	19.50	20.25
JML19FS12	12"	1	<b>25.25</b>	26.50	27.75

**Pro Diatec  
Sliding Bevel**



- Stainless steel blade
- Sliding tempered 9"/225mm blade with knurled locking nut
- Hardwood stock with brass tips
- Right or left handed use.

CODE	Size	Unit	10+	4+	1+
DIA230PAB	9"/225mm	1	<b>8.75</b>	9.50	9.75

**J. Marples  
Sliding Bevel  
Rosewood**



- Rosewood stock with brass wear plates.
- Knurled locking nut.
- Tempered steel blades.
- Made in Sheffield by Joseph Marples.

CODE	Size	Unit	10+	4+	1+
JML20DBEV	7½"	1	<b>16.25</b>	17.75	18.00
JML20EBEV	9"	1	<b>17.75</b>	19.75	20.25

## J. Marples Marking Knife Beech



- An accurate method to marking out prior to cutting.
- Carbon steel blade with brass retaining rivets.
- 2" long blade.
- Beech handle.

CODE	Description	Unit	10+	4+	1+
JML025MRK	Beech	1	5.00	5.75	6.00

## J. Marples Square Head Marking Gauge



- Made in Sheffield by Joseph Marples.
- Made from high quality beech.
- Hardened cutting points and blades.
- Capacity 180mm marking gauge with square head.

CODE	Description	Unit	10+	4+	1+
JML01AMKG	Square Marking	1	5.00	5.75	6.00

## J. Marples Mortise Pullside Marking Gauge Beech

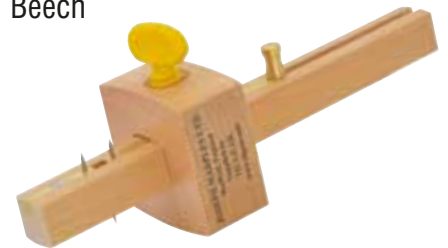

- Made from high quality beech with brass pull-slide.
- Made in Sheffield by Joseph Marples.
- Hardened cutting points.
- Brass slides and fittings.
- With extra scribing point on the reverse.

CODE	Description	Unit	10+	4+	1+
JML007MTG	Beech Pullslide	1	8.25	8.75	9.75

## J Marples Marking Knife Walnut



- An accurate method to marking out prior to cutting.
- Carbon steel blade with brass retaining rivets.
- Walnut handle.
- Size: 2" blade.

CODE	Description	Unit	10+	4+	1+
JML225WMK	Walnut	1	4.70	4.95	5.50

## J. Marples Half Round Marking Gauge



- Made in Sheffield by Joseph Marples.
- Made from high quality beech.
- Hardened cutting points and blades.
- Capacity 180mm marking gauge with brass face.

CODE	Description	Unit	10+	4+	1+
JML002MKG	Half Round Marking	1	9.50	9.95	10.95

## J Marples Mortise Marking Gauge Pullside Walnut

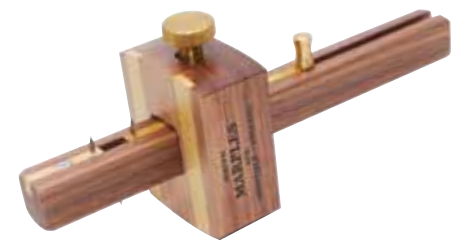

- Made in Sheffield by Joseph Marples.
- Walnut with brass pull-slide and wear-plates.
- Hardened cutting points with additional scribing point on the reverse.

CODE	Description	Unit	10+	4+	1+
JML910WPS	Walnut Pullslide	1	24.75	26.25	28.75

## J. Marples Marking Knife Rosewood



- An accurate method to marking out prior to cutting.
- Carbon steel blade with brass retaining rivets.
- 2" long blade.
- Rosewood handle.

CODE	Description	Unit	10+	4+	1+
JML125MRK	Rosewood	1	5.25	5.75	6.25

## J. Marples Half Round Cutting Gauge



- Made in Sheffield by Joseph Marples.
- Made from high quality beech.
- Hardened cutting points and blades.
- Capacity 180mm marking gauge with brass head.

CODE	Description	Unit	10+	4+	1+
JML004CTG	Half Round Cutting	1	13.50	14.25	15.75

## J Marples Mortise Marking Gauge Screwslice Walnut

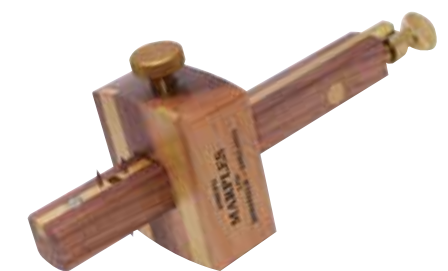

- Made in Sheffield by Joseph Marples.
- Walnut with brass screw-slide and wear-plates.
- Hardened cutting points with additional scribing point on the reverse

CODE	Description	Unit	10+	4+	1+
JML913WSS	Walnut Screwslice	1	40.25	42.75	46.95

## J. Marples Mortise Marking Gauge

Rosewood

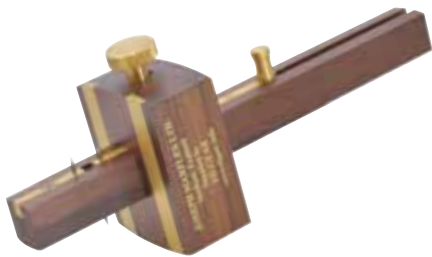

- Made from Rosewood with brass pull-slide and wear-plates.
- Made in Sheffield by Joseph Marples.
- Hardened cutting points.
- Brass slides and fittings.
- With extra scribing point on the reverse.

CODE	Description	Unit	10+	4+	1+
JML10CMTG	Rosewood Pullslide	1	27.75	29.50	32.75

## J. Marples Mortise Screwdriver Marking Gauge

Rosewood



- Made from Rosewood with brass screw-slide and wear-plates.
- Made in Sheffield by Joseph Marples.
- Hardened cutting points.
- Brass slides and fittings.
- With extra scribing point on the reverse.

CODE	Description	Unit	10+	4+	1+
JML13CMTG	Rosewood Screwslide	1	39.95	45.00	47.75

## Replacement Plastic Gauge Screws

Pack of 10



- To fit all standard gauges.

CODE	Description	Unit	4+	1+
JML10PPGS	Gauge Screws Pack of 10		4.10	4.50

## Preston Gents Saw

8"/200mm



- Traditional gents saw with a steel back for control and rigidity.
- SK5 alloy steel blade 8"/200mm x 0.6mm thickness.
- Traditional tooth pattern 15tpi.
- Solid beech handle with a lacquered finish.

CODE	Description	Unit	10+	4+	1+
GTS200STB	8"/200mm	1	9.95	10.75	11.50

## Preston Fine Tooth Back Saw



- Steel backed saw which is sturdy and easy to use.
- Razor sharp fine teeth which have a ground finish.
- Special wavy set teeth to provide a clean and accurate cut.
- Ideal for cutting small wood sections, joints, dowels etc.
- Available in two lengths: 6"/150mm and 8"/200mm.

CODE	Description	Unit	12+	6+	1+
FTS618STB	6"/150mm	1	6.50	6.95	7.95
FTS818STB	8"/200mm	1	6.95	7.75	8.95

## Tajima Katana Japanese Saw



- Traditional Katana style Japanese saw with a rattan bound handle and interchangeable blade.
- Japanese style blades cut 3 times faster than normal saws.
- Triple-edge cutting teeth for a precision straight cut and longer life.
- Easy to install and remove Blades from handles.
- Flexible blade design allows for a flush cut on the horizontal.
- Blade length: 265mm, Blade cut: Fine 16tpi.

CODE	Description	Unit	3+	1+
TAJ265KAT	Katana Saw	1	38.75	40.75
TAJ265BLD	Katana Blade	1	12.25	13.25

## Preston Tenon Saw

10"/250mm



- Traditional tenon saw with a heavy steel back for control and rigidity.
- SK5 alloy steel blade 10"/250mm x 0.6mm thickness.
- Traditional tooth pattern 15tpi.
- Solid beech handle with a lacquered finish.

CODE	Description	Unit	10+	4+	1+
TNS250STB	10"/250mm	1	18.95	19.95	22.95

## Preston Brass Backed Tenon Saw

10"/250mm



- A traditional saw with a universal set tooth which cuts along and across the grain.
- Solid brass back and a high carbon SK5 alloy steel blade.
- Comfortable beech handle securely fixed by rivets.

CODE	Description	Unit	10+	4+	1+
TNS250BRB	10" x 15tpi	1	27.95	29.95	35.95

## Brass Backed Tenon Saw



- A traditional saw with a universal set tooth - cuts along and across the grain.
- Solid brass back and high carbon blade.
- Comfortable beech handle securely fixed by rivets.

CODE	Description	Unit	10+	4+	1+
SAJ300TNS	12" x 15tpi	1	32.95	35.95	38.95

Saws

## Lynx 8" Dovetail Saw



- High quality dovetail saw with a heavy brass back and spring steel blade.
- Fine 8" x 20tpi blade is accurately sharpened for precise cutting.
- Beech handle.

CODE	Size	Unit	4+	1+
DTS820BBS	8" x 20tpi	1	45.00	49.50

## Replacement Saw Screws Pack of 6

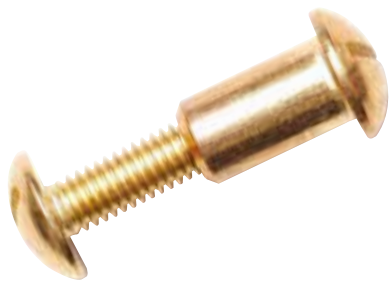

- Replacement saw screws to suit most Tenon, Dovetail and Handsaws.
- Traditional two-part design.
- Brass plated finish.

CODE	Description	Unit	4+	1+
RSS200BPL	Replacement Saw Screws Pack of 6		14.00	16.00

## Preston Hardpoint Tenon Saw



- Double ground 10"/250mm x 15tpi hardpoint blade
- Tech-Grip dual material handle
- Specifically manufactured to give a smooth fast cut
- Steel backed with screwed handle

CODE	Size	Unit	20+	10+	1+
TNS115HPT	10" x 15tpi	1	5.95	6.75	7.50

## Jack Hardpoint Tenon Saw



- Tenon Saw with hard point teeth and a steel back.
- Triple-ground tooth technology optimises cutting performance on both the push and pull strokes.
- Soft-grip handle for user comfort.

CODE	Size	Unit	10+	4+	1+
JAC136010	10" x 13pt	1	8.95	10.00	10.75
JAC136012	12" x 13pt	1	11.25	13.00	14.00

## Irwin Jack Hand Saw



- High quality C75 steel blade, lacquered for added protection
- Unique triple ground tooth design offering up to 25% faster cutting.
- Ultra-sonic welded soft-grip handle for increased hold and enhanced comfort.
- 90° and 45° angles integrated in the handle cutting.

CODE	Size	Unit	4+	1+
JAK820HPS	20" x 8tpi	1	10.95	11.75
JAK822HPS	22" x 8tpi	1	11.95	13.95

## S & J Predator Hardpoint Saw



- Hardened and double ground teeth for fast cutting and long life.
- Screw handle.

CODE	Size	Unit	10+	4+	1+
SAJ228HPS	22" x 8pt	1	9.25	10.00	10.75
SAJ210HPS	22" x 10pt	1	10.00	11.25	11.75

## Preston Coping Saw Wooden Handle



- High quality coping saw designed for cutting curves and shapes.
- Blade can be rotated to cut at any angle by adjusting the end pins.
- Soft grip handle.
- Fitted with a 165mm blade.
- Beech handle.

CODE	Description	Unit	20+	1+
CPS165WHD	Wooden Handle	1	6.95	8.50

## Coping Saw Soft Grip



- High quality coping saw designed for cutting curves and shapes.
- Blade can be rotated to cut at any angle by adjusting the end pins.
- Fitted with a 165mm blade.
- Soft grip handle.

CODE	Description	Unit	20+	10+	1+
ECL70CP1R	Soft Grip	1	8.95	9.25	10.00

## Preston Coping Saw Blades Pack of 10

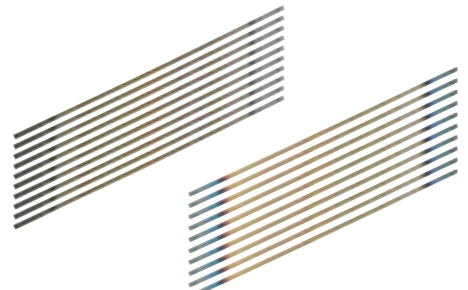

- High quality traditional pinned blade.
- Length 165mm

CODE	Size	Unit	10+	4+	1+
CSB015BLD	165mm 15tpi	Pack of 10	2.25	2.75	3.25
CSB024BLD	165mm 24tpi	Pack of 10	2.75	3.25	3.75



**Eclipse Coping Saw Blades**  
Pack of 10



- High quality traditional pinned blade.

CODE	Description	Unit	10+	4+	1+
ECL71CP7R	165mm 14tpi	Pack of 10	3.25	4.00	4.25
ECL71CP24	165mm 24tpi,	Pack of 10	3.50	4.25	4.50

**Mitre Saw**



- A popular and well designed mitre saw with pre-set locking positions for 4, 5, 6, 8 or 12 sided frames and 90 degree cuts.
- Includes a material clamp and length stop.
- Supplied with a replaceable hardpoint saw blade 550mm x 18tpi.
- Cutting height: 110mm. Cutting width at 90°: 160mm and cutting width at 45°: 100mm.

CODE	Description	Unit	2+	1+
MSW550SAW	Saw	1	47.50	49.95
MSW550BLD	Blade	1	8.95	9.95

**Piercing Saw Frame**

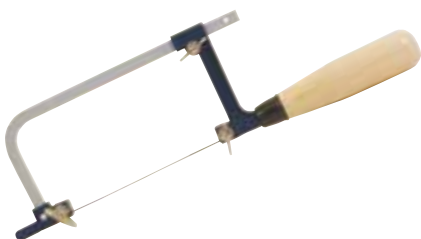

- Piercing or jeweller's bow saw is suitable for extremely fine work.
- Ideal for use by jewellers, clockmakers, model makers, and other skilled craftsmen.
- Adjustable frame allows broken and shorter blades to be used.

CODE	Description	Unit	4+	1+
PSF070130	Piercing Saw Frame	1	8.25	8.95

**Vallorbe Super Piercing Saw Blades**  
Pack of 12



- Genuine Swiss Vallorbe, high precision, rounded back, superior quality.
- Pack of 12 of one gauge.
- Choice of gauge available shown below.
- Blade length 130mm.

CODE	Size	Unit	1+
VAL05PSB	2/0 Gauge 55tpi	Pack of 12	6.95
VAL04PSB	2 Gauge 44tpi	Pack of 12	6.95

**Abrasaw Magic Saw**



- Based on the old Abrafile, this saw will cut metals (both ferrous and non-ferrous), plastics and wood.
- Safety blade suitable for student use, made from special hard steel.
- Cuts in any direction 360 degrees.
- Strong rigid frame is made from lightweight I section alloy with tension screw for a taut blade.
- Depth of throat 125mm/5", blade length 152mm/6".

CODE	Description	Unit	10+	1+
AMS152SAW	Abrasaw	1	11.50	12.95
AMS152BLD	Spare Blade	1	1.75	1.95

**Preston Junior Hacksaw**



- A keenly priced wire frame junior hacksaw - 150mm.
- Traditional junior hacksaw with a study steel frame.
- Fitted with a 150mm blade.

CODE	Description	Unit	20+	10+	1+
JNR150EC3	Preston Junior	1	1.00	1.50	1.75

**Eclipse Junior Hacksaw**



Saws

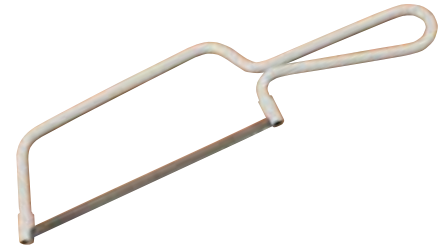

- Traditional junior hacksaw frame with 150mm blade.
- Suitable for cutting wood, metal and plastics.

CODE	Description	Unit	10+	4+	1+
ECL7014JR	Eclipse Junior	1	2.75	3.00	3.25

**Easy-Grip Junior Hacksaw**



- Highly popular in the educational market for younger years.
- Easy-grip handle and robust construction.

CODE	Description	Unit	20+	10+	1+
JNR101EYG	Easy-Grip Junior	1	3.10	3.40	3.80

**Preston Deluxe Junior Hacksaw**



- Large comfortable handle, sturdy rectangular section die-cast frame.
- Metal screw tensioned blade for easy changing.
- Fitted with a 150mm blade.

CODE	Description	Unit	10+	4+	1+
JNR150DLX	Deluxe Junior	1	2.75	2.95	3.95

Saws

## Junior Hacksaw Blades

Pack of 10



- Superior quality junior hacksaw blades made in the UK.
- Standard 150mm pinned pattern to suit all junior frames
- Available in 14tpi for wood, 32tpi for metal and 24tpi for plastic/wood.

CODE	Description	Unit	10+	4+	1+
JHB150WOD	14tpi	Pack of 10	1.75	2.00	2.25
JHB150PLW	24tpi	Pack of 10	1.95	2.10	2.40
JHB150MTL	32tpi	Pack of 10	1.75	2.00	2.25

## Eclipse Junior Hacksaw Blades

Pack of 10



- Replacement 150mm pinned junior hacksaw blades.
- To suit all junior hacksaw frames.
- 32tpi.

CODE	Description	Unit	10+	4+	1+
ECL71132R	Eclipse Junior Blades	Pack of 10	2.75	3.00	3.25

## Preston Pro No.30 Hacksaw



- Traditional robust design for heavy duty workshop use.
- Blade can be angled at 90 degrees for flush cutting.
- Can take either 10"/250mm or 12"/300mm blade.
- Supplied with a 12"/300mm H.S.S Bi-metal blade.

CODE	Description	Unit	10+	4+	1+
PST030HSW	No.30	1	7.75	8.50	9.50

## Eclipse 18T Hacksaw



- 18T offers tremendous value for money without compromising on the strength and lightness.
- Square section steel frame and diecast handle.
- Supplied complete with an Eclipse 12" bimetal blade.

CODE	Description	Unit	4+	1+
ECL018TND	18T Hacksaw	1	10.75	11.25

## Eclipse 20T Hacksaw



- Strong diecast ergonomically shaped handle and rigid oval section frame for comfort and control.
- Blades can be angled at 90° for flush cutting, and can be stored in handle.
- Supplied with a 300mm H.S.S. blade.

CODE	Description	Unit	10+	4+	1+
ECL7020TR	20T Hacksaw	1	12.25	13.50	14.50

## Preston Hi-Leverage Hacksaw



- Lever action adjuster and rigid frame construction creates high tension.
- Taut blade ensures accurate and efficient cutting.
- Dual angle blade mounting.
- Fitted with a 300mm blade.

CODE	Description	Unit	10+	4+	1+
HLH120PRO	Hi-Leverage	1	7.95	8.75	9.95

## Preston Pro HSS Bi-metal Hacksaw Blade

300mm/12" Pack of 10



- Bi-metal blades having an HSS cutting edge, electron beam welded to a flexible alloy back.
- Shatterproof blade which is unbreakable in normal use.

CODE	Size	Unit	4+	1+
HSB018BMT	18tpi	Pack of 10	13.95	15.95
HSB024BMT	24tpi	Pack of 10	13.95	15.95
HSB032BMT	32tpi	Pack of 10	13.95	15.95

## Eclipse All-hard HSS Hacksaw Blades

Pack of 10



- All-hard hacksaw blades are made entirely from HSS.
- Precisely hardened throughout its entire width giving a rigid blade that produces a straight accurate cut
- 300mm/12".

CODE	Size	Unit	4+	1+
ECLAE3045	12" 18tpi	Pack of 10	18.75	21.25
ECLAE3046	12" 24tpi	Pack of 10	18.75	21.25
ECLAE3047	12" 32tpi	Pack of 10	18.75	21.25

## Eclipse H.S.S. Power Hacksaw Blades



- HSS all hard blades for accuracy and long life.
- For use in power hacksaw machines.

CODE	Size	Unit	4+	1+
ECLAE204R	12" x 1" x 0.050" 14tpi	1	11.75	12.25
ECLAE224H	14" x 1" x 0.050" 14tpi	1	14.00	15.25
ECLAE343V	14" x 1 1/4" x 0.062" 10tpi	1	18.50	20.00

## Brook No. 4 Smoothing Plane



- Quality bailey pattern bench planes.
- Heavy cast base with a finely ground accurate sole - length 9 3/4".
- Blade manufactured from extra thick steel for rigidity and are hardened and tempered for a keen, long lasting edge - width 2".
- Traditional hardwood handle having an oil finish.

**BROOK**

CODE	Size	Unit	12+	6+	1+
BRK04SMPL	No.4	1	29.95	32.95	34.95
BRK200BLD	Spare Blade 2"	1	39.95	42.95	

## Brook No. 9 1/2 Block Plane



- An adjustable mouth block plane with a standard cutter angle of 21° with a 1 5/8" wide blade.
- Made from accurately machined fine grey iron - length 6 1/4".
- Fully adjustable for depth of cut, cutter alignment and size of mouth.
- Brass fittings.

**BROOK**

CODE	Size	Unit	6+	1+
BRK0912BP	No. 9 1/2	1	27.50	29.50
BRK158BLD	Spare Blade 1 5/8"	1	9.25	

## Brook No. 311 Shoulder Plane



- An extremely versatile tool having three working modes - as a shoulder plane with the front extension fitted, as a chisel plane with all nose pieces removed and as a bull nose plane with the thinner nose section and shims attached.
- The plane is 155mm (6-1/8") long, by 27mm(1-1/8") being a full width blade.
- Cast iron body which is accurately ground on all faces - length 155mm.
- Blade is manufactured from hardened and tempered steel for a keen, long lasting edge - width 27mm.

**BROOK**

CODE	Description	Unit	2+	1+
BRK311SHP	No. 311	1	59.95	64.95

## Brook No. 5 Jack Plane



- Quality bailey pattern bench planes.
- Heavy cast base with a finely ground accurate sole - length 14".
- Blade manufactured from extra thick steel for rigidity and are hardened and tempered for a keen, long lasting edge - width 2".
- Traditional hardwood handle having an oil finish.

**BROOK**

CODE	Size	Unit	6+	1+
BRK05JKPL	No. 5	1	39.95	42.95
BRK200BLD	Spare Blade 2"	1	11.25	

## Brook No. 60 1/2 Block Plane



- An adjustable mouth block plane with a low cutter angle of 13.5° with a 1 3/8" wide blade.
- Made from accurately machined fine grey iron - length 6 1/4".
- Fully adjustable for depth of cut, cutter alignment and size of mouth.
- Brass fittings.

**BROOK**

CODE	Size	Unit	6+	1+
BRK6012BP	No.60 1/2	1	27.50	29.50
BRK138BLD	Spare Blade 1 3/8"	1	9.25	

## Brook No. 271 Small Router Plane



- Based on the Stanley 271, small router plane.
- Features a stout 1/4" square blade.
- For small relief and shallow mortise work.

**BROOK**

CODE	Size	Unit	6+	1+
BRK271RTP	No. 271	1	19.95	22.95

## Brook No. 10 Rebate Plane



- Quality Bench Rebate Plane based on the old Stanley pattern.
- Heavy cast base with a finely ground accurate sole - length 12 3/4".
- Blade is manufactured from hardened and tempered steel for a keen, long lasting edge - width 2 1/8".
- Traditional hardwood handle having an oil finish.

**BROOK**

CODE	Size	Unit	6+	1+
BRK010RPL	No.10	1	43.25	49.00
BRK218BLD	Spare Blade 2 1/8"	1	12.75	

## No. 778 Duplex Rebate Plane



- A versatile plane with regular and bull nose cutter positions.
- Supplied with twin bar fence, depth gauge, cross-grain spur.
- Cast iron body with and accurately ground sole - length 8 1/2".
- Blade is manufactured from hardened and tempered steel for a keen, long lasting edge - width 1 1/2".

CODE	Size	Unit	6+	1+
BRK778DRP	No. 778	1	55.95	59.95
BRK112BLD	Spare Blade 1 1/2"	1	10.75	

## Brook No. 090 Bull Nose Rebate Plane



- Bull nosed plane with a removable casting to convert into a chisel plane.
- Made from grey cast iron which is accurately ground square and flat.
- Overall length of sole - 100mm.
- Hardened and ground blade - width 25mm.

**BROOK**

CODE	Size	Unit	2+	1+
BRK090BNP	No.090	1	47.95	49.95

Planes

## Brook No. 092 Shoulder Plane



- Shoulder plane with a removable casting to convert into a chisel plane.
- Made from grey cast iron which is accurately ground square and flat.
- Overall length of sole - 125mm.
- Hardened and ground blade - width 19mm.

**BROOK**

CODE	Size	Unit	2+	1+
BRK092SHP	Blade 3/4" x 5"	1	49.95	53.95

## Stanley No. 4 1/2 Smoothing Plane



- The original Bailey pattern bench plane.
- Cast iron body - length 260mm.
- Composite handles.
- Fully adjustable blade - width 60mm.

CODE	Size	Unit	6+	1+
STA112045	No 4 1/2	1	77.95	84.25

## Stanley No. 9 1/2 Block Plane



- Standard angle fully adjustable block plane.
- Cast iron body - length 160mm.
- Cutter sits at 21°.
- Adjustable blade for depth of cut, cutter alignment and size of mouth - width 40mm.

CODE	Size	Unit	12+	6+	1+
STA112020	No 9 1/2	1	64.75	67.75	73.25
STA012508	Spare Blade 1 5/8"	1			10.00

## No. 151 and No.151R Spokeshaves



- Cast iron body with a ground base.
- Fine adjustable blade.
- Available with either flat base, No.151 or convex base (front to back) No.151R.

CODE	Description	Unit	6+	1+
BRK151FSS	151 - Blade 55mm	1	13.95	15.50
BRK151RSS	151R - Blade 55mm	1	13.95	15.50
BRK151BLD	Spare Blade 55mm	1		6.25

## Stanley No. 5 Jack Plane



- The original Bailey pattern bench plane.
- Cast iron body - length 355mm.
- Composite handles.
- Fully adjustable blade - width 50mm.

CODE	Size	Unit	4+	1+
STA112005	No. 5	1	82.95	89.75
STA012313	Spare Blade 2"	1		13.75

## Stanley No. 60 1/2 Block Plane



- Low angle fully adjustable block plane.
- Cast iron body - length 152mm.
- Cutter sits at 13.5°.
- Adjustable blade for depth of cut, cutter alignment and size of mouth - width 35mm.

CODE	Size	Unit	12+	6+	1+
STA112060	No. 60 1/2	1	62.50	65.50	70.75
STA012504	Spare blade	1			10.50

## Stanley No. 4 Smoothing Plane



- The original Bailey pattern bench plane.
- Cast iron body - length 245mm.
- Composite handles.
- Fully adjustable blade - width 50mm.

CODE	Size	Unit	12+	6+	1+
STA112004	No 4	1	66.75	69.75	75.50
STA012313	No 4 Spare Blade 2"	1			13.75

## Stanley No. 7 Jointer/Try Plane



- The original Bailey pattern bench plane.
- Cast iron body - length 560mm.
- Composite handles.
- Fully adjustable blade - width 60mm.

CODE	Size	Unit	4+	1+
STA112007	No 7	1	144.95	156.75

## Stanley No. 220 Block Plane



- Standard angle general purpose block plane.
- Cast iron body - length 178mm.
- Cutter sits at 21°.
- Adjustable blade for depth of cut, cutter alignment and size of mouth - width 40mm.

CODE	Size	Unit	12+	6+	1+
STA112220	No. 220	1	46.25	48.50	52.50
STA012508	Spare Blade	1			10.50

## Cabinet Scraper 5"



- Made from the finest flexible saw steel.
- Size 5" x 2.5".

CODE	Size	Unit	10+	4+	1+
CBS500200	5" x 2½"	1	4.50	4.75	5.00

## Cabinet Scraper 3 Piece Set

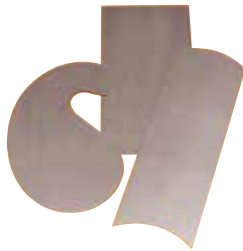

- Made from the finest flexible saw steel.
- Set comprises 5" rectangular, 4.5" gooseneck and 6" double hollow.

CODE	Description	Unit	1+
CBS300SET	3 Cabinet Scrapers	3 Piece	11.25

## Stanley Fat Max Chisels



- Unbreakable bi-material handle with thru-tang blade.
- Steel strikecap - can be used with a steel hammer for increased cutting force.
- Sizes 6, 12, 18, 25, and 32mm included in set.

CODE	Description	Unit	4+	1+
STA516251	1/4"/6mm	1	13.50	14.50
STA516253	3/8"/10mm	1	13.75	14.95
STA516254	1/2"/12mm	1	13.95	15.25
STA516257	5/8"/16mm	1	14.75	15.95
STA516258	3/4"/18mm	1	15.50	16.75
STA516261	1"/25mm	1	17.50	18.95
STA516263	1 1/4"/32mm	1	18.95	20.50
STA516267	2"/50mm	1	29.25	31.50
STA516269	Chisel Set	5 Piece	72.95	78.95

## Preston Traditional Chisels



- Bevel edged chisel, ideal for professionals and colleges.
- Chrome vanadium blade, hardend and ground for edge retention.
- Finely ground bevels with strong tapered bolster.
- Traditional carver pattern handle.

PRESTON					
CODE	Description	Unit	12+	4+	1+
PST006TRC	6mm	1	4.95	5.50	5.75
PST013TRC	13mm	1	5.50	5.75	6.50
PST019TRC	19mm	1	5.75	6.50	7.25
PST025TRC	25mm	1	6.75	7.50	8.75
PST400TRC	Chisel Set	4 Piece	20.95	23.50	26.75

## Irwin Marples MS500 Chisels Set 5 Piece



- One-piece blade forging gives added strength and durability.
- Special tool steel and hardening ensures good edge retention - hardened to the last inch!
- Large metal striking cap to withstand hammer impacts, prolong the handle life.
- ProTouch handles are designed to provide extra comfort, grip, and reduce hand fatigue.
- Sizes: 6, 10, 12, 19, and 25mm (¼, ⅜, ½, ¾, and 1in).

CODE	Description	Unit	10+	4+	1+
MAR505SET	Chisel Set	5 Piece	61.25	64.75	67.50

## Preston Techgrip Chisels



- Bevel edged chisel, ideal for professionals and colleges.
- Chrome vanadium blade, hardend and ground for edge retention.
- Finely ground bevels with strong tapered bolster.
- Tech-Grip material handle with metal striking cap.

PRESTON					
CODE	Description	Unit	12+	4+	1+
PST006SGC	6mm	1	6.50	7.50	8.25
PST013SGC	13mm	1	6.95	7.95	8.75
PST019SGC	19mm	1	7.95	8.75	9.95
PST025SGC	25mm	1	8.95	9.95	10.95
PST400SGC	Chisel Set	4 Piece	27.95	31.95	34.50

## Marples 373 Chisels 6 Piece Chisel Set



- The tradesman's favourite for many years, offered as a comprehensive set of six - ¼", ⅜", ½", ¾", 1 and 1¼".
- Heavy-duty use with split proof handles.
- Quality steel, for improved sharpness and edge retention.
- Blade, bolster and tang are forged from one-piece of steel.
- Edges bevelled to enable easier working in tight corners.

CODE	Description	Unit	4+	1+
MAR3736ST	Chisel Set	6 Piece	95.00	99.00

## Stanley 5002 Bevel Edge Chisels



- Stanley has relaunched their classic 5002 series in a limited range of sizes and the popular 4 piece set (6, 12, 18 and 25mm).
- High carbon bevel edged blade with bolstered shank.
- Polypropylene handle.

CODE	Description	Unit	4+	1+
STA016535	6mm	1	6.25	6.75
STA016540	12mm	1	7.25	7.75
STA016545	18mm	1	8.50	9.50
STA016551	25mm	1	9.75	10.75
STA016129	Set (6, 12, 18 & 25mm)	4 Piece	29.75	32.25

## Sorby Sash Mortise Chisel



- A specialist chisel for forming mortises manufactured with a strong blade to withstand the leverage required to remove the core.
- Unbreakable Cellulose Acetate Butyrate handles.
- Blade manufactured from special alloy steel.
- Constructed to BS1943 specification.

CODE	Size	Unit	4+	1+
SOR332140	1/4"	1	31.25	33.75
SOR332516	5/16"	1	33.50	36.25
SOR332380	3/8"	1	34.50	37.50
SOR332120	1/2"	1	32.25	34.95

## Narex Mortise Chisel



- Forged blade is made of traditional Cr-Mn steel and is heat treated to 59 HRC.
- Sides are taper ground in height and length from tip to shoulder for sidewall clearance.
- Hefty hornbeam hooped handle enables firm grip and is strong enough to withstand heavy blows with a mallet.

CODE	Description	Unit	4+	1+
NRX004MCL	4mm	1	16.95	18.50
NRX006MCL	6mm	1	16.95	18.50
NRX008MCL	8mm	1	16.95	18.50
NRX010MCL	10mm	1	16.95	18.50

## HSS Woodturning Tool Set 8 Piece



- High speed steel blades with hardwood handles.
- 3 x Gouges, 2 x Skew Chisels, 2 x Scrapers and a Parting Tool.
- Supplied in a wooden box.

CODE	Description	Unit	1+
TTL800SET	Set of 8	1	105.00

## Pfeil Chip Carving Knives



- Made from best quality steel, ground and honed for use.
- Available in 6 popular styles available.

CODE	Sweep/Size	Unit	1+
PFL001CCK	1	1	14.95
PFL002CCK	2	1	13.25
PFL003CCK	3	1	13.25
PFL004CCK	4	1	13.25
PFL009CCK	9	1	13.25
PFL010CCK	10	1	13.25

## Pfeil Cutting Tools

- World renowned Swiss made carving chisel and gouges have been developed in conjunction with Brienz Woodcarving School.
- Manufactured from first quality alloy steel, expertly heat treated, finely ground and honed.
- Fitted with octagonal ash handles.

## Pfeil Straight Chisels

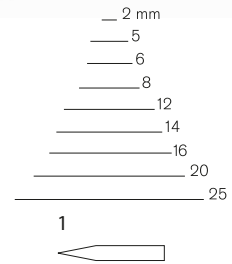

## Sweep Pattern No1 Double Bevel

CODE	Width	Unit	1+
PFL100002	2mm	1	24.25
PFL100005	5mm	1	24.25
PFL100008	8mm	1	24.25
PFL100012	12mm	1	26.25
PFL100016	16mm	1	26.25
PFL100020	20mm	1	31.75
PFL100025	25mm	1	35.25

## Pfeil Skew Chisels

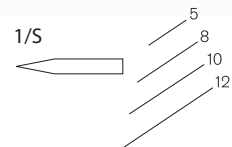

## Sweep Pattern No. 1/S Double Bevel

CODE	Width	Unit	1+
PFL1S0005	5mm	1	24.25
PFL1S0008	8mm	1	24.25
PFL1S0010	10mm	1	26.25
PFL1S0012	12mm	1	26.25

## Pfeil Straight Gouges

(Continued)

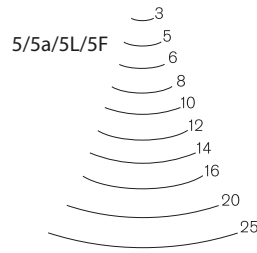

**Sweep Pattern No. 5**

CODE	Width	Unit	1+
PFL500003	3mm	1	<b>24.25</b>
PFL500005	5mm	1	<b>24.25</b>
PFL500008	8mm	1	<b>24.25</b>
PFL500010	10mm	1	<b>26.25</b>
PFL500012	12mm	1	<b>26.25</b>
PFL500014	14mm	1	<b>26.25</b>
PFL500016	16mm	1	<b>26.25</b>
PFL500020	20mm	1	<b>31.75</b>
PFL500025	25mm	1	<b>35.25</b>

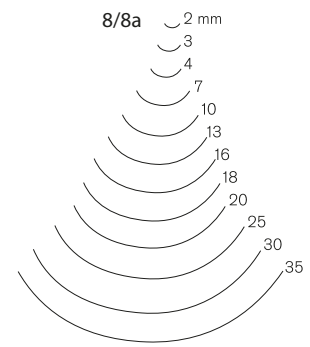

**Sweep Pattern No. 8**

CODE	Width	Unit	1+
PFL800004	4mm	1	<b>24.95</b>
PFL800007	7mm	1	<b>24.95</b>
PFL800010	10mm	1	<b>27.25</b>
PFL800013	13mm	1	<b>27.25</b>
PFL800016	16mm	1	<b>31.95</b>
PFL800020	20mm	1	<b>36.25</b>
PFL800025	25mm	1	<b>36.25</b>

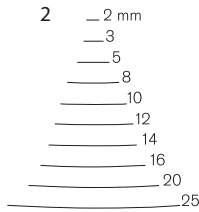

**Sweep Pattern No. 2**

CODE	Width	Unit	1+
PFL200002	2mm	1	<b>24.25</b>
PFL200003	3mm	1	<b>24.25</b>
PFL200005	5mm	1	<b>24.25</b>
PFL200008	8mm	1	<b>24.25</b>
PFL200010	10mm	1	<b>26.25</b>
PFL200012	12mm	1	<b>26.25</b>
PFL200014	14mm	1	<b>26.25</b>
PFL200016	16mm	1	<b>26.25</b>
PFL200020	20mm	1	<b>31.75</b>
PFL200025	25mm	1	<b>35.25</b>

## Straight Gouges

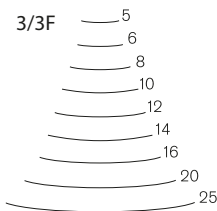
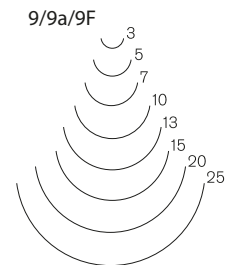
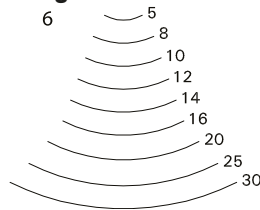

**Sweep Pattern No. 3**

CODE	Width	Unit	1+
PFL300003	3mm	1	<b>24.25</b>
PFL300005	5mm	1	<b>24.25</b>
PFL300008	8mm	1	<b>24.25</b>
PFL300010	10mm	1	<b>26.25</b>
PFL300012	12mm	1	<b>26.25</b>
PFL300014	14mm	1	<b>26.25</b>
PFL300016	16mm	1	<b>26.25</b>
PFL300020	20mm	1	<b>31.75</b>
PFL300025	25mm	1	<b>35.25</b>

**Sweep Pattern No. 6**

CODE	Width	Unit	1+
PFL600005	5mm	1	<b>24.95</b>
PFL600008	8mm	1	<b>24.95</b>
PFL600010	10mm	1	<b>27.25</b>
PFL600012	12mm	1	<b>27.25</b>
PFL600014	14mm	1	<b>27.25</b>
PFL600016	16mm	1	<b>31.95</b>
PFL600020	20mm	1	<b>36.25</b>
PFL600025	25mm	1	<b>36.25</b>

**Sweep Pattern No. 9**

CODE	Width	Unit	1+
PFL900003	3mm	1	<b>24.95</b>
PFL900005	5mm	1	<b>24.95</b>
PFL900007	7mm	1	<b>24.95</b>
PFL900010	10mm	1	<b>27.25</b>
PFL900013	13mm	1	<b>27.25</b>
PFL900015	15mm	1	<b>31.95</b>
PFL900020	20mm	1	<b>36.25</b>
PFL900025	25mm	1	<b>36.25</b>

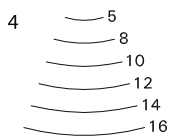

**Sweep Pattern No. 4**

CODE	Width	Unit	1+
PFL400005	5mm	1	<b>24.25</b>
PFL400008	8mm	1	<b>24.25</b>
PFL400010	10mm	1	<b>26.25</b>
PFL400012	12mm	1	<b>26.25</b>
PFL400016	16mm	1	<b>26.25</b>

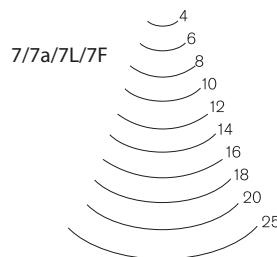

**Sweep Pattern No. 7**

CODE	Width	Unit	1+
PFL700004	4mm	1	<b>24.95</b>
PFL700006	6mm	1	<b>24.95</b>
PFL700008	8mm	1	<b>24.95</b>
PFL700010	10mm	1	<b>27.25</b>
PFL700012	12mm	1	<b>27.25</b>
PFL700014	14mm	1	<b>27.25</b>
PFL700016	16mm	1	<b>31.95</b>
PFL700020	20mm	1	<b>36.25</b>
PFL700025	25mm	1	<b>36.25</b>

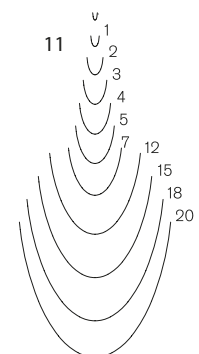

**Sweep Pattern No. 11**

CODE	Width	Unit	1+
PFL110001	1mm	1	<b>27.95</b>
PFL110002	2mm	1	<b>27.95</b>
PFL110003	3mm	1	<b>27.95</b>
PFL110005	5mm	1	<b>27.95</b>
PFL110007	7mm	1	<b>27.95</b>
PFL110012	12mm	1	<b>35.50</b>
PFL110015	15mm	1	<b>35.50</b>
PFL110018	18mm	1	<b>38.25</b>

## Pfeil Spoon Bent



### Sweep Pattern No. 5a

CODE	Width	Unit	1+
PFL5A0005	5mm	1	<b>24.25</b>
PFL5A0008	8mm	1	<b>24.25</b>
PFL5A0012	12mm	1	<b>26.25</b>
PFL5A0016	16mm	1	<b>26.25</b>

### Sweep Pattern No. 7a

CODE	Width	Unit	1+
PFL7A0006	6mm	1	<b>24.95</b>
PFL7A0008	8mm	1	<b>24.95</b>
PFL7A0010	10mm	1	<b>27.25</b>
PFL7A0014	14mm	1	<b>27.25</b>

### Sweep Pattern No. 8a

CODE	Width	Unit	1+
PFL8A0010	10mm	1	<b>27.25</b>
PFL8A0013	13mm	1	<b>27.25</b>
PFL8A0016	16mm	1	<b>31.95</b>
PFL8A0018	18mm	1	<b>31.95</b>

### Sweep Pattern No. 9a

CODE	Width	Unit	1+
PFL9A0003	3mm	1	<b>24.95</b>
PFL9A0005	5mm	1	<b>24.95</b>
PFL9A0007	7mm	1	<b>24.95</b>

## Pfeil Long Bent



### Sweep Pattern No. 5L

CODE	Width	Unit	1+
PFL5L0008	8mm	1	<b>28.25</b>
PFL5L0012	12mm	1	<b>30.75</b>
PFL5L0016	16mm	1	<b>30.75</b>

### Sweep Pattern No. 7L

CODE	Width	Unit	1+
PFL7L0010	10mm	1	<b>30.50</b>
PFL7L0014	14mm	1	<b>30.50</b>
PFL7L0018	18mm	1	<b>37.50</b>

## Pfeil Scorp



- Traditionally used for hollowing chair seats or bowls etc.
- Blade width 32mm and an overall length of 180mm.

CODE	Width	Unit	1+
PFL032SCP	Small - 32mm	1	<b>35.25</b>

## Pfeil Fishtail



### Sweep Pattern No. 1F

CODE	Width	Unit	1+
PFL1F0006	6mm	1	<b>25.95</b>
PFL1F0008	8mm	1	<b>25.95</b>
PFL1F0012	12mm	1	<b>28.25</b>
PFL1F0014	14mm	1	<b>28.25</b>

### Sweep Pattern No. 3F

CODE	Width	Unit	1+
PFL3F0006	6mm	1	<b>29.25</b>
PFL3F0008	8mm	1	<b>29.25</b>
PFL3F0012	12mm	1	<b>30.95</b>
PFL3F0014	14mm	1	<b>30.95</b>

### Sweep Pattern No. 5F

CODE	Width	Unit	1+
PFL5F0006	6mm	1	<b>29.25</b>
PFL5F0008	8mm	1	<b>29.25</b>
PFL5F0012	12mm	1	<b>30.95</b>
PFL5F0014	14mm	1	<b>30.95</b>

### Sweep Pattern No. 7F

CODE	Width	Unit	1+
PFL7F0006	6mm	1	<b>29.25</b>
PFL7F0008	8mm	1	<b>29.25</b>
PFL7F0010	10mm	1	<b>29.25</b>
PFL7F0014	14mm	1	<b>30.95</b>

### Sweep Pattern No. 9F

CODE	Width	Unit	1+
PFL9F0005	5mm	1	<b>29.25</b>
PFL9F0010	10mm	1	<b>31.95</b>

## Pfeil Dog Leg

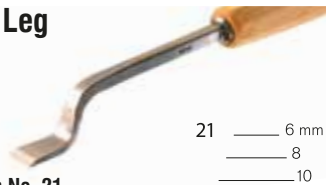

### Sweep Pattern No. 21

CODE	Width	Unit	1+
PFL210006	6mm	1	<b>29.95</b>
PFL210008	8mm	1	<b>29.95</b>
PFL210010	10mm	1	<b>29.95</b>

## Pfeil Carving Chisel Set in Canvas Roll 8 Piece Set



- An introductory set of tools for the carving enthusiast consisting of seven full size tools and one carving knife, supplied in a rugged canvas roll.
- Set includes: 1/12mm, 1S/12mm, 5/12mm, 4/20mm, 7/10mm, 9/4mm, 12/8mm and No.12 Knife.

CODE	Description	Unit	1+
PFLR08SET	Chisel Set	8 Piece	<b>256.50</b>

## Pfeil Vee Gouges

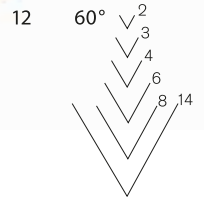
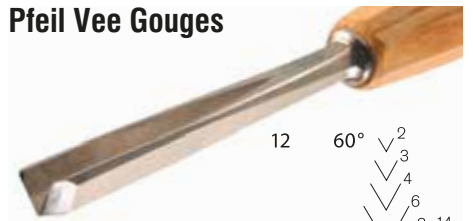

### Sweep Pattern No. 12

CODE	Width	Unit	1+
PFL120002	2mm	1	<b>28.75</b>
PFL120003	3mm	1	<b>28.75</b>
PFL120004	4mm	1	<b>28.75</b>
PFL120006	6mm	1	<b>28.75</b>
PFL120008	8mm	1	<b>32.75</b>
PFL120014	14mm	1	<b>37.75</b>

### Sweep Pattern No. 13

CODE	Width	Unit	1+
PFL130004	4mm	1	<b>28.75</b>
PFL130006	6mm	1	<b>28.75</b>
PFL130008	8mm	1	<b>32.75</b>

### Sweep Pattern No. 15

CODE	Width	Unit	1+
PFL150003	3mm	1	<b>29.25</b>
PFL150006	6mm	1	<b>32.50</b>

## Pfeil Reverse Bent



### Sweep Pattern No. 28

CODE	Width	Unit	1+
PFL280006	6mm	1	<b>31.50</b>
PFL280010	10mm	1	<b>31.50</b>

## Pfeil Carving Chisel Set in Canvas Roll 12 Piece Set Pfeil Canvas Roll



- Our most popular set of twelve tools covering a broad range of carving requirements supplied in a rugged canvas roll.
- Set includes: 1/8mm, 1S/8mm, 5/8mm, 5/20mm, 7/6mm, 7/14mm, 7L/20mm, 8/4mm, 8a/10mm, 9/10mm, 11/3mm, 12/6mm.

CODE	Description	Unit	1+
PFLR012ST	Chisel Set	12 Piece	<b>372.25</b>
PFLR12CR	Roll Only-2 x Rows 6 Pkts	1	<b>55.95</b>



## Fine Palm Carving Tools

Set A



Set B



Set C



- Often referred to as lino and block cutters.
- Made from best quality steel, ground and honed for use.
- Overall size of 125mm and with a blade length of 70mm.
- Fitted with a palm style maple handle.
- Available individually or as a 6 piece set.

### Set A

CODE	Sweep/Size	Unit	1+
PFL1008FP	1/8mm	1	<b>20.75</b>
PFL1S08FP	1 S/8mm	1	<b>20.75</b>
PFL1A08FP	1 a/8mm	1	<b>21.25</b>
PFL5008FP	5/8mm	1	<b>20.75</b>
PFL1103FP	11/3mm	1	<b>21.25</b>
PFL12A4FP	12 a/4mm	1	<b>21.25</b>
PFLSETAFP	Complete Set of 6	1	<b>126.95</b>

### Set B

CODE	Sweep/Size	Unit	1+
PFL5003FP	5/3mm	1	<b>20.75</b>
PFL7006FP	7/6mm	1	<b>20.75</b>
PFL7010FP	7/10mm	1	<b>20.75</b>
PFL9005FP	9/5mm	1	<b>21.25</b>
PFL1101FP	11/1mm	1	<b>21.25</b>
PFL1201FP	12/1mm	1	<b>21.25</b>
PFLSETBFP	Complete Set of 6	1	<b>126.95</b>

### Set C

CODE	Sweep/Size	Unit	1+
PFL8003FP	8/3mm	1	<b>20.75</b>
PFL8007FP	8/7mm	1	<b>20.75</b>
PFL9002FP	9/2mm	1	<b>20.75</b>
PFL1105FP	11/0.5mm	1	<b>21.25</b>
PFL1204FP	12/4mm	1	<b>21.25</b>
PFL1502FP	15/2mm	1	<b>21.25</b>
PFLSETCFP	Complete Set of 6	1	<b>126.95</b>

## Canary Safety Cardboard Cutter



- A Teflon coated steel blade with fine serrations (similar to a dinner knife) - not overly sharp but will saw through cardboard with ease.
- Fitted with a tough moulded plastic handle.
- The rounded end enables the user to pierce through cardboard to start a cut in the middle of a panel.
- A far safer option to a trimming knife, but obviously children will still need supervising.

CODE	Description	Unit	20+	6+	1+
CBC190SAF	Cardboard Cutter	1	<b>5.95</b>	6.50	6.75

## Cutting Mats

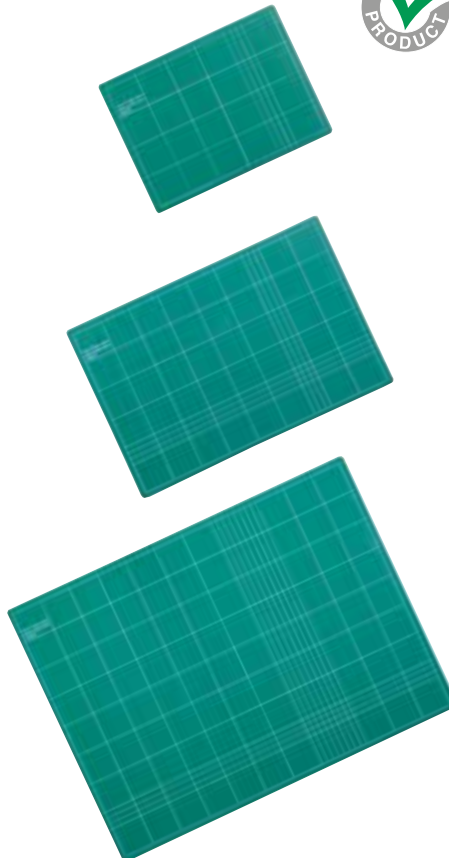

- Durable self-healing cutting mats.
- Double sided construction.
- Available in three popular sizes.

CODE	Description	Unit	10+	4+	1+
CTM0912A4	9" x 12" (A4)	1	<b>2.50</b>	2.95	3.50
CTM1218A3	12" x 18" (A3)	1	<b>4.75</b>	5.25	6.00
CTM1824A2	18" x 24" (A2)	1	<b>9.50</b>	10.75	11.75
CTM2436A1	24" x 36" (A1)	1	<b>22.50</b>	24.75	28.00

## Swann Morton Scalpels



### Standard

- Slim stainless steel handle in two sizes.
- No.3 takes the small range of blades nos. 10-15.
- The larger No.4 takes the mid range of blades nos. 24-27.

CODE	Size	Unit	10+	1+
SWM080301	Std. No. 3 Handle	1	<b>5.50</b>	5.95
SWM080401	Std. No. 4 Handle	1	<b>5.50</b>	5.95

## Blades to suit No.3 Handle and Retractable Pack of 100



- These blades have a durability, sharpness and consistency that is second to none.
- Unique fitment to fasten to No.3 or Retractable handle securely.
- Pack of 100.

CODE	Size	Unit	4+	1+
SWM101100	10	Pack of 100	<b>13.95</b>	15.25
SWM102100	10A	Pack of 100	<b>13.95</b>	15.25
SWM103100	11	Pack of 100	<b>15.50</b>	16.95

## Blades to suit No.4 Handle Pack of 100



- These blades have a durability, sharpness and consistency that is second to none.
- Unique fitment to fasten to No.4 handle securely.
- Pack of 100.

CODE	Size	Unit	4+	1+
SWM115100	25A	Pack of 100	<b>15.75</b>	16.95
SWM113100	26	Pack of 100	<b>15.75</b>	16.95
SWM114100	27	Pack of 100	<b>15.75</b>	16.95

Knives

## Swann Morton Trimaway Knife Pack of 50



- High quality disposable knife.
- Fitted with a 25A blade.
- Strong red nylon handle.

CODE	Description	Unit	4+	1+
SWM180150	Trimaway Knife Pack of 50		30.95	33.50

## Swann Morton Retractable Knives



- Slim nickel alloy handle.
- Takes blades No.10A, No.10 and No.11.

CODE	Size	Unit	10+	1+
SWM280601	Retractable	1	7.75	8.50

## Aluminium Craft Knife



- Solid aluminium handle 120mm, with a collet type blade clamp.
- Round handle 7mm diameter, for pen like control.

CODE	Size	Unit	10+	1+
KNF120CRF	Aluminium	1	3.10	3.40

## Swann Morton Craft Knife



- Manufactured by SwannMorton - a world renowned surgical scapel company.
- This original craft knife has a moulded plastic handle with a metal clamping screw.
- Takes No. 1 blade.

CODE	Description	Unit	10+	1+
SWM1231CK	Handle and 2 Blades	1	2.20	2.35

## No. 1 Blades to suit Swann Morton Craft Knife Pack of 50



- Blades to suit Swann Morton Craft Knife.

CODE	Description	Unit	4+	1+
SWM1241BL	No.1 Blades Pack of 50		7.25	7.75

## Stainless Steel Scalpel Handle No.3



- Stainless steel No. 3 scalpel handle.
- Suits all blades with No. 3 fitment.

CODE	Size	Unit	10+	1+
KNF301HDL	No. 3	1	2.30	2.50

## Scalpel Blades No.10, 10A and 11 Pack of 100

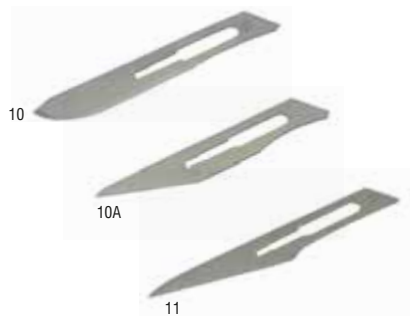

- Stainless steel scalpel blades for intricate cutting, individually wrapped.
- Available in 3 styles, all with No. 3 fitment.

CODE	Size	Unit	4+	1+
KNB101SBL	No. 10	Pack of 100	9.95	11.25
KNB102SBL	No. 10A	Pack of 100	9.95	11.25
KNB103SBL	No. 11	Pack of 100	9.95	11.25

## Craft Blades Pack of 5



- Blades to suit the Aluminium Craft handle.

CODE	Size	Unit	4+	1+
KNB005CBL	Spare Blades Pack of 5		1.75	1.95

## Pro Retractable Knife



- Retractable knife with rapid blade change.
- Safety strapping cutter.
- Supplied with five blades.

CODE	Description	Unit	12+	6+	1+
KNF456PRO	Pro Knife	1	6.75	7.25	7.75

## Retractable Trimming Knife



- Retractable fixed blade trimming knife with cross-over casting to prevent blade movement.
- Metal die-cast body has blade storage.
- Takes heavy duty knife blades.

CODE	Description	Unit	10+	4+	1+
TTKRETKNF	Retractable Trimming	1	2.50	2.75	2.95

## Stanley 99E Retractable Knife



- Steel slider allows blade to be retracted or held in intermediate position.
- Die-cast metal body.

CODE	Description	Unit	4+	1+
STA110099	Stanley 99E Knife	1	7.75	8.50

## Stanley 088 Lightweight Knife



- Light but strong ABS body with quick opening for blade changing.

CODE	Description	Unit	4+	1+
STA010088	Stanley 088 Knife	1	3.20	3.50

## Stanley Springback Safety Knife



- Blade automatically springs back inside the knife body as soon as pressure on the shifter button is released.
- Supplied with a special round nose and heavy-duty blade for ultimate safety.
- Red high visibility body which is ribbed to provide a firm grip.

CODE	Description	Unit	4+	1+
STA110189	Springback	1	8.95	9.75

## Heavy Duty Knife Blades Pack of 10 or 100



- Heavy duty knife blades to fit Stanley or similar knives.
- High quality steel sharpened to a keen long-lasting edge.

CODE	Description	Unit	10+	1+
KNB061HDB	Heavy Duty	Pack of 10	1.25	1.50
KNB160HDB	Heavy Duty	Pack of 100	7.75	8.95

## Snap-Off Knife 9mm Individual or Pack of 10



- An upgraded snap-off blade knife with a metal blade holder for extra safety.
- Tough plastic outer handle.
- Positive blade lock.
- 9mm blade width.

CODE	Size	Unit	4+	1+
KNF009SNP	9mm	1	0.75	1.15
KNF910ECN	9mm	Pack of 10	5.95	6.95

## Snap-Off Knife 18mm Individual or Pack of 10



Knives



- An upgraded snap-off blade knife with a metal blade holder for extra safety.
- Tough plastic outer handle.
- Positive blade lock.
- 18mm blade width.

CODE	Size	Unit	4+	1+
KNF018SNP	18mm	1	1.25	1.75
KNF181ECN	18mm	Pack of 10	8.95	9.95

## Stanley Snap-Off Knives



- Takes the economical and convenient snap-off blades, in sizes 9mm or 18mm.
- These models have a lightweight but strong ABS construction.

CODE	Description	Unit	4+	1+
STA010150	9mm	1	1.30	1.40
STA010151	18mm	1	2.70	2.90

## Snap-off Knife Blades Pack of 10



- Snap-off blades are available in two sizes; 9mm and 18mm.

CODE	Description	Unit	10+	1+
KNB091SNO	9mm	Pack of 10	1.50	1.75
KNB181SNO	18mm	Pack of 10	1.75	2.00

## Stanley Surform Planer File



- Tough yellow polypropylene handle can be set in two positions to enable use as either a plane or file.
- Tough black diecast alloy body, fitted with standard cut blade.
- Specially shaped teeth bite into material and then allow shavings to pass through without clogging.
- Able to deal with materials that would ruin a normal plane.
- Blade length 250mm.

CODE	Description	Unit	4+	1+
STA521122	Planer File	1	21.75	23.50
STA521393	Fine Blade	1	3.80	4.10
STA521299	Half Round Blade	1	4.60	4.95
STA521508	Multi-use Blade	1	4.95	5.50

## Stanley Surform Round File

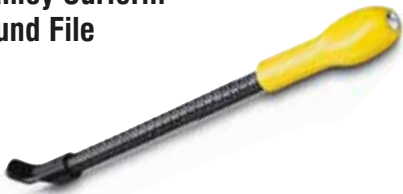

- Useful for sculpturing, shaping or enlarging holes.
- Tough yellow plastic handle.
- Front piece removable for blade change.
- Blade length 250mm.

CODE	Description	Unit	4+	1+
STA521297	Round File	1	11.95	12.95
STA521291	Round Blade	1	6.25	6.75

## Stanley Surform Block Plane



- Small one handed block plane surform for general shaping and stock removal.
- Specially shaped teeth bite into material and then allow shavings to pass through without clogging.
- Able to deal with materials that would ruin a normal plane.
- Fitted with a flat 140mm blade.

CODE	Description	Unit	6+	1+
STA521104	Block Plane Surform	1	7.75	8.50
STA521398	Blade	1	3.50	3.80

## Stanley Surform Shaver Tool



- The smallest in the surform family with an upright handle.
- Short 60mm blade which is curved front to back.

CODE	Description	Unit	6+	1+
STA521115	Shaver Tool	1	3.70	3.95
STA521515	Blade	1	2.05	2.20

## Wooden File Handles Pack of 10



- Timber handle for durability.
- Metal ferrule.

CODE	Size	Unit	5+	1+
FHA300WDN	3"	Pack of 10	8.95	9.75
FHA400WDN	4"	Pack of 10	9.25	9.95
FHA500WDN	5"	Pack of 10	10.25	10.95
FHA600WDN	6"	Pack of 10	11.95	12.95

## Stromberg Flat Rasps



- Designed to shape wood, fillers and soft metals such as lead or aluminium.
- Flat hand pattern.
- Ideally suited for use with Python safety handles.
- All in second cut.

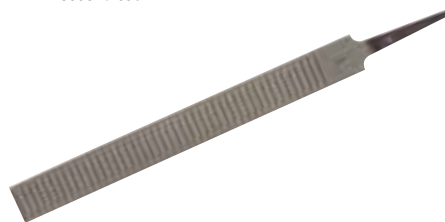

### Flat Rasps

CODE	Size	Unit	5+	1+
SBG080FMR	8"/200mm	1	4.50	4.95
SBG100FMR	10"/250mm	1	5.25	5.95

## Stromberg Rasps



- Designed to shape wood, fillers and soft metals such as lead or aluminium.
- Available in round, half round and cabinet pattern.
- Ideally suited for use with Python safety handles.
- Cabinet pattern has a flatter half round section, and is tapered towards the tip with a finer cut.
- All in second cut.



### Round Rasps

CODE	Size	Unit	5+	1+
SBG080RMR	8"/200mm	1	3.50	3.95
SBG100RMR	10"/250mm	1	4.50	4.95



### 1/2 Round

CODE	Size	Unit	5+	1+
SBG080HMR	8"/200mm	1	4.75	5.75
SBG100HMR	10"/250mm	1	6.50	7.95



### Cabinet 1/2 Round

CODE	Size	Unit	5+	1+
SBG080CMR	8"/200mm	1	5.95	7.25
SBG100CMR	10"/250mm	1	6.50	7.95

## Standard Needle File Set 6 Piece



- Popular fine files for intricate work.
- Set of 6 profiles as shown below.
- Overall length 160mm.



CODE	Description	Unit	6+	1+
NEF600SET	Standard Needle File Set	6 Piece	4.50	5.50

## Diamond Needle File Set 10 Piece



- A comprehensive set of diamond coated needle files, for filing hard materials.
- Ten various different profiles with handles.
- Overall length 160mm.
- Diamond coating length 50mm.

CODE	Description	Unit	6+	1+
LYX100NEE	Needle File Set	10 Piece	10.00	11.25

## Engineers File/Rasp Set 5 Piece



- Set of popular styles; flat, half round, round, triangular and a half round wood rasp
- Second cut, 8"/200mm cutting length.
- Supplied with handles.

CODE	Description	Unit	6+	1+
EFS5PC800	File/Rasp	5 Piece	15.75	18.50

## Modelmakers' File Set 6 Piece



- Intermediate sized file (slightly larger in section than a needle file).
- Popular shapes supplied complete with handles.
- Overall length of 170mm.

CODE	Description	Unit	6+	1+
MDF6PCSET	Modelmakers' File Set	6 Piece	7.75	9.00

## Needle File Set - Handled 6 Piece



- Bi-material plastic handle.
- 100mm working length.
- Files:- Flat, Warding, Square, Triangular, Round.

CODE	Description	Unit	6+	1+
NEF103SET	6 Piece Set	1	5.25	6.50

## Wood Rasp Set 3 Piece



- Set of popular styles; flat, half round and round.
- Medium cut, 8"/200mm cutting length.
- Supplied with handles.

CODE	Description	Unit	6+	1+
RAS803SET	Preston Wood Rasp Set	3 Piece	10.75	11.75

## Standard Needle File Set 12 Piece

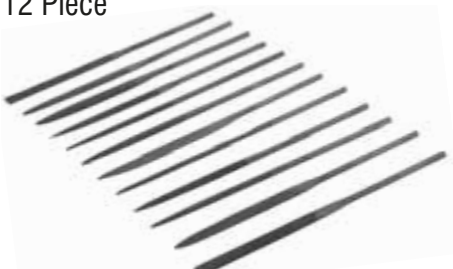

- Popular fine files for intricate work.
- Set of 12 profiles as shown below.
- Overall length 160mm.

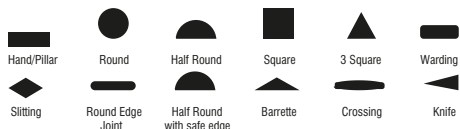

CODE	Description	Unit	6+	1+
NEF120SET	Standard Needle File Set	12 Piece	9.00	10.00

## Engineers File Set 3 Piece



- Set of popular styles; hand, half round and round.
- Second cut, 8"/200mm cutting length.
- Supplied with handles.

CODE	Description	Unit	6+	1+
EFS803SET	Engineers File Set	3 Piece	10.00	11.25

## File Card Brush



- Removes loading from file teeth to restore their cutting efficiency.
- File card size 40 x 100mm
- Wooden handle for ease of use 250mm length.

CODE	Size	Unit	6+	1+
FCB512112	5½" x 1½"	1	4.40	4.95

## Stromberg Files

- Professional quality files for industrial applications
- Supplied un-handled

### Stromberg Round



#### Smooth

CODE	Size	Unit	10+	1+
SBG060RDS	6"	1	3.25	4.00
SBG080RDS	8"	1	3.75	4.75
SBG100RDS	10"	1	5.25	6.25

#### Medium (Second)

CODE	Description	Unit	10+	1+
SBG060RDM	6"	1	2.75	3.75
SBG080RDM	8"	1	3.50	4.50
SBG100RDM	10"	1	4.50	5.00

#### Coarse (Bastard)

CODE	Description	Unit	10+	1+
SBG060RDC	6"	1	2.75	3.25
SBG080RDC	8"	1	3.25	3.75
SBG100RDC	10"	1	4.50	5.25

### Stromberg Three Square



#### Smooth

CODE	Size	Unit	10+	1+
SBG060TRS	6"	1	3.75	4.50
SBG080TRS	8"	1	4.50	5.75
SBG100TRS	10"	1	6.75	8.50

#### Medium (Second)

CODE	Description	Unit	10+	1+
SBG060TRM	6"	1	3.00	3.75
SBG080TRM	8"	1	3.75	4.50
SBG100TRM	10"	1	5.95	7.50

#### Coarse (Bastard)

CODE	Description	Unit	10+	1+
SBG060TRC	6"	1	2.75	3.75
SBG080TRC	8"	1	3.50	4.25
SBG100TRC	10"	1	5.50	6.75

### Stromberg Half Round



#### Smooth

CODE	Size	Unit	10+	1+
SBG060HRS	6"	1	5.00	6.00
SBG080HRS	8"	1	5.75	7.00
SBG100HRS	10"	1	8.00	9.50

#### Medium (Second)

CODE	Description	Unit	10+	1+
SBG060HRM	6"	1	4.50	5.25
SBG080HRM	8"	1	5.00	6.00
SBG100HRM	10"	1	6.75	8.00

#### Coarse (Bastard)

CODE	Description	Unit	10+	1+
SBG060HRC	6"	1	4.00	4.75
SBG080HRC	8"	1	4.75	5.75
SBG100HRC	10"	1	6.50	8.00

### Stromberg Square



#### Smooth

CODE	Size	Unit	10+	1+
SBG060SQS	6"	1	3.50	4.50
SBG080SQS	8"	1	4.50	5.25
SBG100SQS	10"	1	5.75	6.75

#### Medium (Second)

CODE	Description	Unit	10+	1+
SBG060SQM	6"	1	3.00	3.75
SBG080SQM	8"	1	3.50	4.50
SBG100SQM	10"	1	5.00	6.00

#### Coarse (Bastard)

CODE	Description	Unit	10+	1+
SBG060SQC	6"	1	3.00	3.75
SBG080SQC	8"	1	3.50	4.25
SBG100SQC	10"	1	4.50	5.75

## Stromberg Hand Files



#### Smooth

CODE	Size	Unit	10+	1+
SBG040HDS	4"	1	2.75	3.25
SBG060HDS	6"	1	3.50	4.25
SBG080HDS	8"	1	4.50	5.25
SBG100HDS	10"	1	5.25	6.25
SBG120HDS	12"	1	7.00	8.75

#### Medium (Second)

CODE	Description	Unit	10+	1+
SBG040HDM	4"	1	2.50	3.25
SBG060HDM	6"	1	3.50	4.00
SBG080HDM	8"	1	3.50	4.25
SBG100HDM	10"	1	4.75	5.75
SBG120HDM	12"	1	6.50	8.00

#### Coarse (Bastard)

CODE	Description	Unit	10+	1+
SBG040HDC	4"	1	2.50	2.75
SBG060HDC	6"	1	3.00	3.75
SBG080HDC	8"	1	3.50	4.25
SBG100HDC	10"	1	4.50	5.75
SBG120HDC	12"	1	6.25	7.75

## Stromberg Handled Files



- Hand 8" Second Cut fitted with handle.
- Half Round 8" Second Cut fitted with handle.
- Round 8" Second Cut fitted with handle.

CODE	Description	Unit	10+	1+
SBG082HDH	Hand 8"	1	5.50	6.25
SBG082HRH	Half Round 8"	1	4.75	5.50
SBG082RDH	Round 8"	1	4.50	4.75

## Softgrip Screwdriver



- Bi-material softgrip handle.
- Chrome vanadium blade.
- Black finished magnetic tip.

CODE	Description	Unit	12+	6+	1+
SDR375SLS	Slotted 3 x 75mm	1	1.45	1.75	2.25
SDR410SLS	Slotted 4 x 100mm	1	1.80	2.00	2.25
SDR510SLS	Slotted 5.5 x 100mm	1	1.90	2.25	2.75
SDR615SLS	Slotted 6.5 x 150mm	1	2.30	2.75	3.25
SDR075PHS	Phillips No.0 x 75mm	1	1.45	1.75	2.25
SDR110PHS	Phillips No.1 x 100mm	1	1.90	2.25	2.75
SDR215PHS	Phillips No.2 x 150mm	1	2.30	2.75	3.25
SDR110PZS	Pozi No.1 x 100mm	1	1.90	2.25	2.75
SDR215PZS	Pozi No.2 x 150mm	1	2.30	2.75	3.25

## Softgrip Screwdriver Set 6 Piece



- A six piece set of screwdrivers: Slotted 5.5 & 6.5mm, Phillips No.1 & 2 and Pozi No.1 & 2.
- Bi-material softgrip handle.
- Chrome vanadium blade.
- Black finished magnetic tip.

CODE	Description	Unit	4+	1+
SDR600SET	6 Piece Set	1	9.50	10.00

## Pro Precision Screwdriver Set 6 Piece



- Bi-material softgrip handle.
- Chrome vanadium blade.
- Contains:- 2 x 50, 2.5 x 50, 3.0 x 50, PH000 x 50, PH00 x 50, PH0 x 50mm.

CODE	Description	Unit	6+	1+
PSD600SET	6 Piece Set	1	7.95	8.95

## Screwdriver Ratchet Handle Bit Set 26 Piece



- Reversible ratchet screwdriver handle.
- 60mm adaptor.
- Screwdriver bits:- Slotted 4, 5, 6, 7mm, PH0, PH1, PH2, PH3, PZ0,PZ1,PZ2,PZ3, T10, T15, T20, T25, T30, T40, Hex:2,2.5,3,4,5,6mm.

CODE	Description	Unit	4+	1+
BTS260SET	26 Piece Set	1	8.95	9.75

## Ratchet Handle Socket Bit Set 38 Piece



- Reversible ratchet handle - 1/4" drive.
- 75mm extension bar and adaptor.
- 1/4" sockets:- 5, 6, 7, 8, 9, 10, 11, 12, 13mm  
Screwdriver bits:- Slotted 3, 4, 5, 6mm, PH0, PH1, PH2, PH3, PZ0, PZ1, PZ2, PZ3, T10, T15, T20, T25, T27, T30, T40, Hex: 2, 2.5, 3, 4, 5, 5.5, 6mm".

CODE	Description	Unit	4+	1+
BTS380SET	38 Piece Set	1	11.95	12.95

## Economy Bradawls Pointed



- Pointed chisel.
- Plastic handle.

CODE	Description	Unit	10+	1+
ECN01BAWL	Pointed	1	1.95	2.30

## Economy Bradawls Rounded



- Round chisel.
- Plastic handle.

CODE	Description	Unit	20+	10+	1+
ECN02BAWL	Round	1	1.85	1.95	2.30

## Square Pointed Bradawl



- Beech wood handle with brass ferrule.
- 1 1/2" long blade.

CODE	Description	Unit	12+	1+
JML11226S	Square Pointed	1	5.50	5.95

## Precision Screwdriver Set 6 Piece



- 6 piece set contains: 1.4, 1.8, 2.3 and 3.0mm slot, and nos. 0 and 1 crosspoint tip screwdrivers.
- Hardened blades.
- Chrome plated polished handles with serrated grip.
- Hexagonal revolving heads.

CODE	Description	Unit	1+
PRN6PCSET	Precision Screwdriver Set	6 Piece	<b>3.25</b>

## Mains Tester Screwdriver



- A neon indicator in a clear plastic handle with a metal earth stud in the top.
- Lights upon voltages between 100-500V.
- Insulated sleeve on the screwdriver blade.
- 4mm tip, overall length 185mm.

CODE	Description	Unit	10+	1+
SDR185TES	Mains Tester Screwdriver	1	<b>2.50</b>	2.70

## Standard Screwdriver Bit Set 33 Piece



- Convenient bit-tidy containing hex bits, torx bits and a selection of the most popular screwdriver bits as listed, together with a magnetic holder. Tips included:
- Slotted tips: 1 each, 3, 4, 5, 6 and 7mm.
- Phillips tips: 1 x No.0, 2 x No.1, 3 x No.2, 2 x No.3.
- Pozi drive tips: 2 x No.1, 3 x No.2, 2 x No.3.
- Hex bits: 1 each, 2, 2.5, 3, 4, 5 and 6mm.
- ¼" hex drive magnetic bit holder.

CODE	Description	Unit	1+
BTS33PASS	Standard Bit Set	33 Piece	<b>7.75</b>

## Security Bit Set 100 Piece



- A very comprehensive bit set which includes the standard pozi drive, phillips, slotted, hex and torx bits.
- Includes a magnetic bit holder, and a ¼" socket adaptor.
- Also many other specialist and security bits such as, Robertson, two pin, tri-wing, hex with pin hole etc.

CODE	Description	Unit	1+
BTS100SEC	Security Bit Set	100 Piece	<b>10.75</b>

## Pro Impact Driver Bits Slotted 25mm Pack of 10



- High quality impact resistant 25mm screwdriver bits for use in the most demanding applications.
- ¼" Hexagon drive 25mm bits specially designed for use with impact drivers, but can be used in any other driver.
- Tough, absorbing and magnesium phosphate coated for excellent wear resistance.

### Slotted 25mm

CODE	Description	Unit	4+	1+
IDB253SLT	Slotted 3.5 x 25mm	Pack of 10	<b>8.75</b>	9.50
IDB254SLT	Slotted 4.5 x 25mm	Pack of 10	<b>8.75</b>	9.50
IDB255SLT	Slotted 5.5 x 25mm	Pack of 10	<b>8.75</b>	9.50
IDB256SLT	Slotted 6 x 25mm	Pack of 10	<b>8.75</b>	9.50

## Pro Impact Driver Bits Phillips 25mm Pack of 10

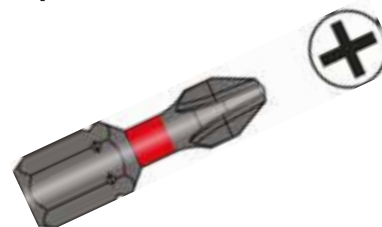

- High quality impact resistant 25mm screwdriver bits for use in the most demanding applications.
- ¼" Hexagon drive 25mm bits specially designed for use with impact drivers, but can be used in any other driver.
- Tough, absorbing and magnesium phosphate coated for excellent wear resistance.

### Phillips 25mm

CODE	Description	Unit	4+	1+
IDB251PHP	PH1 x 25mm	Pack of 10	<b>6.95</b>	7.75
IDB252PHP	PH2 x 25mm	Pack of 10	<b>6.95</b>	7.75
IDB253PHP	PH3 x 25mm	Pack of 10	<b>6.95</b>	7.75

## Pro Impact Driver Bits Pozi 25mm Pack of 10



- High quality impact resistant 25mm screwdriver bits for use in the most demanding applications.
- ¼" Hexagon drive 25mm bits specially designed for use with impact drivers, but can be used in any other driver.
- Tough, absorbing and magnesium phosphate coated for excellent wear resistance.

### Pozi 25mm

CODE	Description	Unit	4+	1+
IDB251PZP	PZ1 x 25mm	Pack of 10	<b>6.95</b>	7.75
IDB252PZP	PZ2 x 25mm	Pack of 10	<b>6.95</b>	7.75
IDB253PZP	PZ3 x 25mm	Pack of 10	<b>6.95</b>	7.75

## Pro Impact Driver Bits Phillips 50mm Pack of 10



- High quality impact resistant 50mm screwdriver bits for use in the most demanding applications.
- ¼" Hexagon drive 50mm bits specially designed for use with impact drivers, but can be used in any other driver.
- Tough, absorbing and magnesium phosphate coated for excellent wear resistance.

### Phillips 50mm

CODE	Description	Unit	4+	1+
IDB501PHP	PH1 x 50mm	Pack of 10	<b>10.95</b>	11.95
IDB502PHP	PH2 x 50mm	Pack of 10	<b>10.95</b>	11.95
IDB503PHP	PH3 x 50mm	Pack of 10	<b>10.95</b>	11.95

## Pro Impact Driver Bits Pozi 50mm Pack of 10



- High quality impact resistant 50mm screwdriver bits for use in the most demanding applications.
- ¼" Hexagon drive 50mm bits specially designed for use with impact drivers, but can be used in any other driver.
- Tough, absorbing and magnesium phosphate coated for excellent wear resistance.

### Pozi 50mm

CODE	Description	Unit	4+	1+
IDB501PZP	PZ1 x 50mm	Pack of 10	<b>10.95</b>	11.95
IDB502PZP	PZ2 x 50mm	Pack of 10	<b>10.95</b>	11.95
IDB503PZP	PZ3 x 50mm	Pack of 10	<b>10.95</b>	11.95



## Screwdriver Bit Set

15 Piece



- Popular screwdriver bit set, made from S2 steel, satin finished.
- 14 pcs ¼" x 25mm bits sizes: SL5, SL6, SL7, PH1, PH2, PH3, PZ1, PZ2, PZ3, T10, T15, T20, T25, T30.
- Includes screwdriver bit holder ¼" x 60mm.

CODE	Description	Unit	4+	1+
BTS015ASS	15 Piece	1	5.25	5.95

## Screwdriver Bit Holders



- Universal magnetic bit holder with hex shank.
- ¼" hex shank with ¼" hex socket.

CODE	Description	Unit	10+	1+
WHA1895UM	Magnetic Bit Holder	1	3.30	3.50

## Bulk Screwdriver Bits

Pack of 100



- Popular No.2 Pozix 25mm.
- Chrome vanadium steel.

CODE	Description	Unit	1+
SBT200PZB	No. 2 x 25mm	Pack of 100	10.25

## Quick Release Screwdriver Bit-Fix Holder ¼"



- Quick release bit-fix holder fits directly into drill chuck.
- For quick change of screwdriver bits and all ¼" shank drill accessories.

CODE	Description	Unit	1+
SBT140HLD	¼ Hex Shank	1	3.95

## Folding Key Sets

Hex Set or Torx Set

8 Piece



- Penknife style, folding key set.
- Keys can't be lost.
- Available in either metric ball-end hex or torx.

CODE	Description	Unit	4+	1+
HEX800SET	Hex Set 1.5-8mm	8 Piece	4.75	5.25
TRX800SET	Torx Set T9 to T40	8 Piece	5.00	5.50

## Hex Key Set

30 Piece



- Comprehensive 30 piece hex key set covering both metric and Imperial keys down to small micro sizes.
- Clean finished ends.
- Robust folding case.
- Contents: Metric Standard Series: 0.7mm - 10mm, Imperial Long Series: 0.028" - 3/8".

CODE	Description	Unit	1+
HEX30PSET	Hex Key Set	30 Piece	13.50

## T-Handle Hex Key Set

10 Piece



- Ideal for workshop use, both ends of the hex key can be used.
- Complete with metal storage stand.
- T-handle design for greater torque.
- Metric 10 piece set: 2, 2.5, 3, 4, 4.5, 5, 5.5, 6, 8 and 10mm.

CODE	Description	Unit	1+
HEX10PMET	Hex Key Set	10 Piece	13.95

## Bondhus Folding Hex Key Sets

7 or 9 Piece



- Keys made from high grade chrome-vanadium steel and heat treated for maximum torque, made in USA
- Key ends are chamfered to eliminate burrs which would prevent an accurate fit.
- Handle is of fibreglass reinforced plastic for additional strength and a comfortable grip.
- Metric 7 piece Set: 2, 2.5, 3, 4, 5, 6 and 8mm.
- Imperial 9 piece Set: 5/64", 3/32", 7/64", 1/8", 9/64", 5/32", 3/16", 7/32" and 1/4".

CODE	Description	Unit	1+
BON12587M	Metric Set	7 Piece	8.50
BON12589I	Imperial Set	9 Piece	8.50

## Long Pattern Hex and Torx Sets

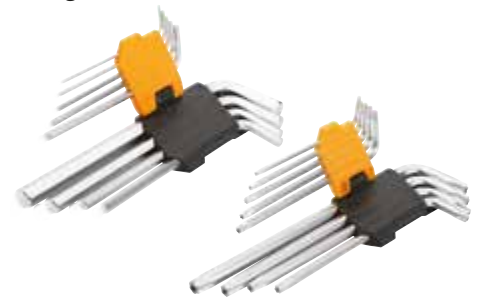

- Fully hardened chrome vanadium sets, plated finish and supplied in a storage clip.
- Compact design for toolboxes and long reach keys for easy access or high leverage.
- Metric 9 piece set: 1.5, 2, 2.5, 3, 4, 5, 6, 8 and 10mm.
- Torx 9 piece set: T10, T15, T20, T25, T27, T30, T40, T45 and T50.

CODE	Description	Unit	1+
HXB10LMET	Metric Set	9 Piece	6.95
TRX90LSET	Torx Set	9 Piece	7.95

## Hex Key Set

10 Piece



- Standard length hexagon keys.
- Clean, square ends with a bevelled edges for easy entry.
- Sizes: 1.5, 2, 2.5, 3, 4, 5, 5.5, 6, 8 and 10mm.
- Supplied on a traditional ring with spring holders.

CODE	Sizes	Unit	4+	1+
HEX100SET	1.5 - 10mm	10 Piece	3.00	3.25

## Industrial Socket Set 1/4" Drive 46 Piece



- A range of industrial quality socket sets with chrome vanadium sockets and a variety of attachments.
- Sockets: 4, 4.5, 5, 5.5, 6, 7, 8, 9, 10, 11, 12, 13, 14mm.
- Screwdriver bits: T10, T15, T20, T25, T30, T40, PH1, PH2, PH3, PZ1, PZ2, PZ3, Slot: 4, 5.5, 6.5mm, Hex: 2, 2.5, 3, 4, 5, 6mm.
- Ratchet handle.
- Sliding bar.
- Screwdriver handle.
- Universal joint.
- Extension bars: 50 & 100mm.
- Adaptor: 25mm.
- Flexible bar: 150mm.
- Hex keys: 1.27, 1.5, 2.0, 2.5mm.

CODE	Description	Unit	2+	1+
SST460CRV	46 Piece	1	29.95	33.75

## Industrial Socket Set 1/2" Drive 22 Piece



- An industrial quality 1/2" drive socket set with chrome vanadium sockets.
- Sockets: 10, 11, 12, 13, 14, 15, 16, 17, 18, 19, 22, 24, 27, 30, 32mm.
- Spark plug sockets: 16 & 21mm.
- Quick release ratchet bar.
- Extension bars: 125 & 250mm.
- Universal joint.
- 3-way adaptor.
- Industrial Socket Set 22pce - 1/2" drive.

CODE	Description	Unit	2+	1+
SST220CRV	1/2" drive	1	49.95	56.25

## Industrial Socket Set 1/4" and 1/2" Drive Set 43 Piece



- An industrial quality 1/4" and 1/2" drive socket set with chrome vanadium sockets.
- Reversible chrome molybdenum ratchet handles - 1/4" and 1/2".
- 1/2" Sockets 10, 11, 12, 13, 14, 15, 16, 17, 18, 19, 20, 21, 22, 23, 24, 27, 30, 32mm.
- 1/2" Accessories: Extension Bars 125mm and 250mm, Spark Plug Sockets 16mm and 21mm, Universal Joint and 3 Way Adaptor.
- 1/4" Sockets 4, 5, 5.5, 6, 7, 8, 9, 10, 11, 12, 13, 14mm
- 1/4" Accessories: Socket Handle, Extension Bars 50mm and 100mm, Universal Joint, Flexible Bar and Sliding Bar.

CODE	Description	Unit	2+	1+
SST430CRV	43 Piece	1	59.50	69.50

## Reversible Ratchet Handle



- Industrial quality ratchet with 72 tooth reversing mechanism
- Chrome molybdenum with a satin finish
- Two-component ergonomic handle
- Quick release button for easy socket change.

CODE	Description	Unit	1+
LYX140RTH	1/4" Drive	1	7.75
LYX380RTH	3/8" Drive	1	10.50
LYX120RTH	1/2" Drive	1	11.50

## Adjustable Spanners



- Chrome plated drop forged adjustable spanner.

CODE	Description	Unit	4+	1+
ADS060STD	6"	1	3.50	3.95
ADS080STD	8"	1	4.95	5.75
ADS100STD	10"	1	6.25	6.95
ADS120STD	12"	1	7.95	8.95
ADSSETSTD	6", 8" and 10 Set	3 Piece	13.50	14.95

## Professional Wrenches



- Metric scale laser etched onto the jaw ensures fast setting.
- Ergonomic soft feel sleeve gives maximum comfort and grip.
- Available in 6", 8" and 10" sizes.

CODE	Size	Unit	4+	1+
ADS060PRO	6"	1	6.50	7.25
ADS080PRO	8"	1	7.25	8.50
ADS100PRO	10"	1	10.75	11.75

## Extra Wide Jaws



- Extra wide 50mm jaw capacity.
- Thin jaws allow access to confined spaces.
- Chrome vanadium steel for maximum strength.

CODE	Description	Unit	4+	1+
ADS100EWJ	10"/250mm	1	22.50	23.50

## Automatic Sheath Cutter



- This tool automatically adjusts to remove insulation off flex from 0.2mm<sup>2</sup> to 6mm<sup>2</sup> section.
- Fitted with wire cutters.

CODE	Description	Unit	6+	1+
AWS106220	Auto Sheath Cutter	1	4.95	5.75

## Professional Wire Stripper



- Fully automatic stripping of outer sheaths and inner wire from cables. 0.13mm<sup>2</sup> - 6mm<sup>2</sup>.
- Also crimps most common terminals.
- Incorporates wire cutters.

CODE	Description	Unit	1+
WST613PRO	Pro Wire Stripper	1	19.75

## Combination Spanner Set 6 Piece



- Chrome vanadium combination spanner set.

CODE	Size	Unit	1+
CSS81706P	8-17mm Set	6 Piece	<b>7.95</b>

## Combination Spanner Set 12 Piece



- Chrome vanadium combination spanner set.

CODE	Size	Unit	1+
CSS81912P	8-19mm Set	12 Piece	<b>15.25</b>

## Combination Spanner Set 22 Piece



- Drop-forged hardened tempered chrome vanadium with polished faces.
- Combination ring and open spanner.
- Metric sizes: 6, 8, 9, 10, 11, 12, 13, 14, 17, 19 and 22mm.
- AF sizes: 1/4", 5/16", 3/8", 7/16", 1/2", 9/16", 5/8", 11/16", 3/4", 13/16" and 7/8".

CODE	Size	Unit	1+
CSS62212P	6-22mm Set	22 Piece	<b>26.75</b>

## Combination Spanners



- Popular sizes available individually.
- Chrome vanadium steel.

CODE	Size	Unit	4+	1+
CSS007CMB	7mm (= M4 nut)	1	<b>1.35</b>	1.45
CSS008CMB	8mm (= M5 nut)	1	<b>1.40</b>	1.50
CSS010CMB	10mm (= M6 nut)	1	<b>1.65</b>	1.85
CSS013CMB	13mm (= M8 nut)	1	<b>1.95</b>	2.10
CSS017CMB	17mm (= M10 nut)	1	<b>3.10</b>	3.40
CSS019CMB	19mm (= M12 nut)	1	<b>3.90</b>	4.20

## Wire Stripper Bib Type



- These robust simple wire strippers are often known as Bib type.
- PVC dipped handles and fitted with spring return.
- Adjustable sliding screw can be pre-set to suit the required wire gauge between 0.5mm to 4.0mm.
- Overall length 130mm.

CODE	Description	Unit	6+	1+
WRS525BBT	Bib Type	1	<b>2.95</b>	3.75

## Stromberg Pro-Pincer



- 8" quality pincer manufactured from chrome-vanadium.
- Accurately finished jaws and non-slip handles.

CODE	Description	Unit	6+	1+
PRO200PNC	8" Pro-pincer	1	<b>5.50</b>	6.75

## Traditional Pincers



- Drop forged.
- Traditional pincer - 200mm length.

CODE	Description	Size	Unit	6+	1+
TPC200DFP	Traditional Pincers	200mm	1	<b>3.95</b>	4.95

## Flush Cutting Plier



- Rated for cutting soft wire up to 18 AWG (1mm).
- Perfect for electronics where flush or close trimming is required.
- Also for flexible stranded bead wire or craft wire.
- Overall length 130mm.

CODE	Description	Unit	6+	1+
SCT600FLS	Flush	1	<b>2.95</b>	3.25

## Wire Rope Cutter



- Designed to cut wire rope up to 5mm in diameter without splaying ends.
- Spring-loaded handles.
- High carbon steel blades, hardened and tempered.
- Cuts spring wire up to 1.5mm diameter.

CODE	Description	Unit	1+
WRC200515	Wire Rope Cutter	1	<b>20.75</b>

## Stromberg Electronic Pliers Individual and 3 Piece Set



- Ground grips and cutting edges are satin finished for protection and a precision appearance.
- Generous sized bi-material handles produce a better grip and comfort.
- Precision small pliers which are ideally suited for delicate or electronic and electrical work.
- Overall length 4 1/2" / 115mm.
- Set comprises: combination, snipe nose and side cutters.

CODE	Description	Unit	12+	4+	1+
SBG115CMB	Combination	1	<b>2.75</b>	2.95	3.50
SBG115SPN	Snipe Nose	1	<b>2.75</b>	2.95	3.50
SBG115SCT	Side Cutters	1	<b>2.75</b>	2.95	3.50
SBG3PCSET	3 Piece Set	1	<b>7.75</b>	8.25	9.00

## Stromberg Pliers Individual and 3 Piece Set



- Heat treated heads for longer life and durability.
- Ground grips and cutting edges are satin finished for protection and a precision appearance.
- Generous sized bi-material handles produce a better grip and comfort.
- Overall length 6 1/4" / 160mm.
- Set comprises one of each: 6" combination, 6" long nose and 6" side cutters.

CODE	Description	Unit	24+	6+	1+
SBG160CMB	6" Combination	1	4.50	4.95	5.50
SBG160LGN	6" Long Nose	1	4.25	4.75	5.25
SBG160SCT	6" Side	1	4.50	4.95	5.50
SBG163SET	Pliers Set	3 Piece	13.00	14.25	16.25

## Stromberg Wire Strippers 6"

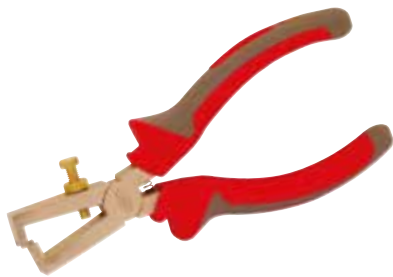

- Heat treated heads for longer life and durability.
- Ground grips and cutting edges are satin finished for protection and a precision appearance.
- Generous sized bi-material handles produce a better grip and comfort.
- Overall length 6 1/4" / 160mm.

CODE	Description	Unit	24+	6+	1+
SBG160WRS	6"	1	4.75	5.25	6.00

## Deburring Tool



- Swivelling cranked cutter deburrs holes fast and neat.
- Tough ABS handle.
- S10 blade for steel and aluminium.

CODE	Description	Unit	6+	1+
EXAAE1000	Edge Off	1	5.50	6.00

## Circlip Plier Set 4 Piece



- 2 x internal and 2 x external pliers.
- Both cranked and straight points.
- Carbon steel with nickel finish.

CODE	Description	Unit	1+
CPS4PCSET	Circlip Pliers Set	4 Piece	16.75

## Stromberg Aviation Compound Snips 250mm



- Drop forged alloy steel blades giving a longer cutting life.
- Spring loaded handles ensure a fast, smooth cutting action.
- Cuts up to 1.2mm cold rolled steel and 0.7mm stainless steel.

CODE	Description	Unit	4+	1+
SBG300ASS	250mm	1	8.95	9.95

## Sheet Metal Cutter



- For cutting sheet metal of up to 20 gauge.
- The centre blade has an upward cutting action and shears without distorting the sheet.

CODE	Description	Unit	4+	1+
SMC756CTR	Metal Cutter	1	29.95	31.95
SMC756BLD	Spare Blades	1	7.95	

## Pro Water Pump Pliers 250mm/10"



- Parallel action jaws with an accurately machined joint which will not slip under load.
- Jaws are suitable for both flat and pipe grip with auto-tightening jaw grip.
- Boxed joint pivot for maximum support and strength Chrome vanadium steel.

CODE	Description	Unit	12+	6+	1+
WPP250CRV	250mm	1	6.75	7.75	9.00

## Stromberg Small Tinsnips 7"



- Ideal for younger students - often referred to as 'Jewellers Tinsnips'.
- Drop forged handles with a hard wearing enamel finish.
- Induction hardened and tempered blades which are hollow ground.
- High tensile pivot bolt.

CODE	Description	Unit	10+	4+	1+
TNS070JWL	7" Small Tinsnips	1	6.00	6.95	8.25

## Stromberg General Purpose Tinsnips 8", 10" and 12"



- These Stromberg General Purpose Tinsnips are ideal for industry and education
- Drop forged handles with a hard wearing enamel finish.
- Induction hardened and tempered blades which are hollow ground.
- High tensile pivot bolt.

CODE	Description	Unit	10+	4+	1+
TNS080GNP	8" Tinsnips	1	7.00	8.25	9.25
TNS100GNP	10" Tinsnip	1	8.25	9.50	10.75
TNS120GNP	12" Tinsnip	1			16.00

## Curved Self Locking Pliers



- Made from drop forged heat treated steel with plated finish.
- Fitted with quick release lever.
- Available as a set of 3 - 5", 7" & 10" or individual 10" and 9" long nose.

CODE	Description	Unit	6+	1+
SLP100CJW	10" Curved	1	4.95	5.95

## Professional Curved Locking Pliers



- High quality industrial range for the professional.
- Superb tool made from drop forged heat treated steel with plated finish.
- Fitted with quick release lever.
- Usable as pliers, clamps or hand vice.
- Curved jaws for general purpose use.

CODE	Size	Unit	5+	1+
PRF10LPCR	10"	1	9.95	10.95

## Welding Clamp



- Self locking action with adjusting screw and quick release lever.
- Plated steel construction.
- Fork style clamping action with open area for welding.
- 10"/250mm.

CODE	Size	Unit	5+	1+
WCL105WLP	Welding	1	9.95	10.95

## Long Nose Self Locking Pliers



- Made from drop forged heat treated steel with plated finish.
- Fitted with quick release lever.
- Available as a set of 3 - 5", 7" & 10" or individual 10" and 9" long nose.

CODE	Description	Unit	6+	1+
SLP090LGN	9" Long Nose	1	5.25	6.25

## Professional Straight Locking Pliers



- High quality industrial range for the professional.
- Superb tool made from drop forged heat treated steel with plated finish.
- Fitted with quick release lever.
- Usable as pliers, clamps or hand vice.
- Straight jaws for an increased and positive grip on nuts and flat surfaces

CODE	Size	Unit	5+	1+
PRF10LPST	10"	1	9.95	10.95

## Welding Clamp C-Clamp



- Self locking action with adjusting screw and quick release lever.
- Plated steel construction.
- Deep throated clamp, useful to reach over obstructions.
- 11"/280mm.

CODE	Size	Unit	5+	1+
WCL110CLP	C-Clamp	1	9.50	10.25

## Self Locking Pliers Set 3 Piece



- Made from drop forged heat treated steel with plated finish.
- Fitted with quick release lever.
- Set includes sizes; 5", 7" and 10".

CODE	Description	Unit	1+
SLP3PCSET	Self Locking Pliers Set	3 Piece	13.50

## Welding Clamp Sheet Metal



- Self locking action with adjusting screw and quick release lever.
- Plated steel construction.
- Wide flat jaws to clamp sheet metal evenly.
- 10"/250mm.

CODE	Size	Unit	5+	1+
WCL100SLP	Sheet Metal	1	8.50	9.95

## Welding Clamp Set 3 Piece



- Self locking action with adjusting screw and quick release lever.
- Plated steel construction.
- Self grip action with adjusting screw and quick release lever.
- Set consists of: 10" sheet metal clamp - 4" wide jaws, 9" welding clamp - 2 3/4" wide jaws and 11" C-clamp - 3 1/2" diameter.

CODE	Size	Unit	1+
WCL3PCSET	Welding Clamp Set	3 Piece	29.25

## Industrial Bolt Cutter



- Solid forged handles for maximum strength.
- Centre cut, arm adjusted bolt cutters.
- Drop forged jaws are machined to precise specifications.
- Cutting Capacity 8mm (5/16") max.

CODE	Description	Size	Unit	12+	6+	1+
BLC240HVD	Eclipse Bolt Cutter	610mm/24"	1	<b>23.95</b>		

## Combination Pro Pliers



- An industrial range of pliers with advanced steel alloy for better edge retention and life.
- Bi-material handles for improved grip.
- Chrome Vanadium heat-treated steel.

CODE	Size	Unit	12+	6+	1+
PPL180CMB	180mm/7"	1	<b>7.00</b>	7.50	8.25

## Side Cutters Pro Pliers



- An industrial range of pliers with advanced steel alloy for better edge retention and life.
- Bi-material handles for improved grip.
- Chrome Vanadium heat-treated steel.

CODE	Size	Unit	12+	6+	1+
PPL160SCT	160mm/6 1/4"	1	<b>6.50</b>	7.00	7.50

## Long Nose Pro Pliers



- An industrial range of pliers with advanced steel alloy for better edge retention and life.
- Bi-material handles for improved grip.
- Chrome Vanadium heat-treated steel.

CODE	Size	Unit	12+	6+	1+
PPL160LGN	160mm/6 1/4"	1	<b>6.00</b>	6.50	7.00

## Bent Nose Pro Pliers



- Industrial plier with advanced steel alloy for better edge retention and life.
- Bi-material handles for improved grip.
- Chrome Vanadium heat-treated steel.

CODE	Size	Unit	12+	6+	1+
PPL160BTN	160mm/6 1/4"	1	<b>6.25</b>	6.75	7.25

## Mini Bolt Cutter



- A useful tool which bridges the gap between side cutters and full-sized bolt cutters.
- Induction hardened cutting edges.
- Comfortable PVC handle grips.
- Overall length 200mm.

CODE	Size	Unit	6+	1+
BLC008MIN	Mini Bolt Cutter	1	<b>7.00</b>	8.25

## Preston Hickory Range Pin Hammer 4oz



- Fully heated treated ground head.
- Ring wedge fastening the head to handle.
- Selected hickory shaft with FSC stamp.

CODE	Description	Unit	12+	6+	1+
HAM004PHM	Pin 4oz	1	<b>6.75</b>	6.95	7.95

## Preston Hickory Range Joiners Warrington Hammers 8oz and 12oz



- Fully heated treated ground head.
- Ring wedge fastening the head to handle.
- Selected hickory shaft with FSC stamp.

CODE	Description	Unit	12+	6+	1+
HAM008CWT	Joiners 8oz	1	<b>7.50</b>	7.95	8.95
HAM012CWT	Joiners 12oz	1	<b>8.50</b>	8.95	9.95

## Preston Hickory Range Engineers Ball Pein Hammers 1/4lb - 2lb



- Fully heated treated ground head.
- Ring wedge fastening the head to handle.
- Selected hickory shaft with FSC stamp.

CODE	Description	Unit	12+	6+	1+
HAM140EBP	Ball Pein 1/4lb	1	<b>9.00</b>	9.25	10.00
HAM120EBP	Ball Pein 1/2lb	1	<b>9.50</b>	9.95	10.75
HAM340EBP	Ball Pein 3/4lb	1	<b>9.95</b>	10.75	11.50
HAM100EBP	Ball Pein 1lb	1	<b>10.95</b>	11.95	12.95
HAM112EBP	Ball Pein 1 1/2lb	1	<b>14.50</b>	15.25	16.25
HAM200EBP	Ball Pein 2lb	1	<b>16.25</b>	17.75	19.00

## Pin Hammer 4oz



- Drop forged head with polished striking faces.
- Hickory shaft for strength.

CODE	Description	Unit	12+	6+	1+
HAM400BPH	Pin 4oz	1	<b>3.95</b>	4.75	5.95

## Claw Hammer Steel Shaft 16oz and 20oz



- Drop forged head with polished face and claw.
- Tubular steel handle for strength.
- Rubberised soft grip handle.

CODE	Size	Unit	12+	4+	1+
HAM160BCH	Claw 16oz	1	<b>4.75</b>	5.75	6.75
HAM200BCH	Claw 20oz	1	<b>5.25</b>	5.95	6.95

## Pro Claw Hammer Fibreglass Shaft 16oz



- Fully heated treated 16oz ground head, virtually unbreakable fibreglass shaft - permanently bonded to the head,
- Non-slip and durable 'Techgrip' handle.

CODE	Description	Unit	12+	6+	1+
CLH160FGH	Fibre Glass Shaft 16oz	1	<b>7.50</b>	8.25	8.75

## Warrington Hammer 8oz



- Drop forged head with polished striking faces.
- Hickory shaft for strength.

CODE	Description	Unit	12+	6+	1+
HAM800BWT	Warrington 8oz	1	<b>4.95</b>	5.95	6.95

## Preston Claw Hammer Steel Shaft 20oz



- Heat treated head.
- Tubular steel handle and rubber grip.

CODE	Description	Unit	12+	6+	1+
HAM200SCL	Steel Shaft 20oz	1	<b>7.95</b>	8.50	8.95

## Pro Claw Hammer Solid Steel Shaft 16oz



- 16oz heat treated head.
- One piece head and shaft design.
- Accurately ground claw.
- Bi-material handle for better grip.

CODE	Description	Unit	12+	6+	1+
HAM160SSS	Solid Steel Shaft	1	<b>12.95</b>	13.95	14.95

SEE VOCATIONAL

## Club Hammers



## Stanley Claw Hammer 16oz and 20oz



- Drop forged head.
- Tubular steel handle comfortable vinyl grip.

CODE	Description	Unit	6+	1+
STA151488	Claw 16oz	1	<b>12.75</b>	13.75
STA151489	Claw 20oz	1	<b>13.75</b>	14.95

## Estwing Claw Hammer 20oz



- Superior quality USA made hammer.
- Forged one-piece construction.
- Nylon/vinyl grip bonded to the shaft.

CODE	Description	Unit	6+	1+
ESTE320CV	Claw 20oz	1	<b>39.75</b>	41.95

Hammers

## Ball Pein Hammer Fibreglass Shaft 1lb and 2lb



- Drop forged head and polished faces.
- Fibreglass shaft for use in demanding conditions.

CODE	Description	Unit	12+	6+	1+
HAM100FGB	1lb	1	<b>6.95</b>	7.50	7.95
HAM200FGB	2lb	1	<b>7.95</b>	8.75	9.50

## Stubby Ball Pein Hammer 8oz



- This hammer has been specifically designed with younger children in mind - for safety, control and grip.
- 8oz ball pein head (not claw) for safety.
- Short fibreglass shaft for increased control.
- Soft rubber grip for all ages.

CODE	Description	Unit	12+	5+	1+
HAM008SMH	Ball Pein 8oz	1	<b>3.95</b>	4.50	4.95

## Welders Chipping Hammers 300g



- Striking head with a sharp conical point and a flat chisel bevelled end.
- Unique helical barrel spring handle helps to prevent kickback.

CODE	Description	Unit	12+	6+	1+
HAM300WCH	300g	1	<b>4.95</b>	5.50	5.95

SEE VOCATIONAL

## Brick Hammers



## Slaters Hammer 20oz



- Pointed end for piercing slates prior to fixing
- Striking face for counter-sinking slate lath fixing nails
- Chequered striking face helps reduce overstrike on nails
- Side claw for removal of old nails from slates
- Hickory shaft

CODE	Description	Unit	10+	5+	1+
HAM240SLH	Slaters 20oz	1	<b>29.95</b>	31.95	32.95

## Carver's Beech Mallet



- Made in the UK for Tilgear,
- Straight grained Beech for impact resistance and durability.

CODE	Description	Unit	1+
CRV312BEC	Beech 3½"	1	<b>18.95</b>

## Carpenter's Mallet

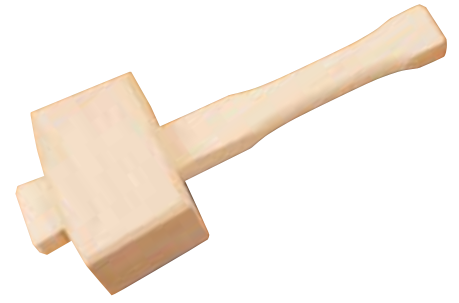

- Traditional design with a taper mortised head.
- Measures 4½" across the centre of the head.
- Made from selected beech.

CODE	Description	Unit	24+	6+	1+
CRN412CRM	4½" Head Size	1	<b>7.75</b>	8.50	8.95

## Utility Bar 15" Pro



- Manufactured from high quality alloy steel and powder coated to ensure maximum resistance to rusting.
- Flat bar with bevelled nail slots makes pulling, scraping, prying and lifting easier.
- Shepherd's Crook' rocker head for maximum prying power.
- 15"/380mm.

CODE	Size	Unit	6+	1+
UTR150FLT	15"	1	<b>5.50</b>	6.75

## Wrecking Bar

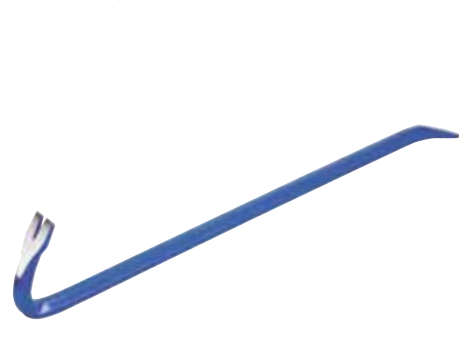

- Hexagonal bar for strength.
- Claw and chisel ends.

CODE	Size	Unit	6+	1+
WRB450HEX	450mm	1	<b>6.75</b>	7.25
WRB600HEX	600mm	1	<b>7.00</b>	7.50



**Black Rubber Mallet**  
16oz



- Black solid rubber head.
- Hardwood handle.

CODE	Description	Unit	12+	6+	1+
HAM016BRM	16oz	1	4.50	5.00	5.50

**Soft Faced Hammer**



- Dual head 35mm - PVC and rubber.
- Fibreglass shaft.

CODE	Description	Unit	6+	1+
HAM350DUL	Dual 35mm	1	7.50	7.95

**Thor Copper and Rawhide Hammer**



- One face of copper, one of seasoned water buffalo hide
- Wooden handle and malleable iron head.

CODE	Description	Unit	4+	1+
THO114RC1	1¼"	1	21.95	22.95
THO112RC2	1½"	1	28.50	29.95
THO134RC3	1¾"	1	35.75	37.95
THO200RC4	2"	1	51.50	53.95

**White Rubber Mallet**  
16oz



- White no-mar solid rubber head.
- Hardwood handle.

CODE	Description	Unit	12+	6+	1+
HAM016WRM	16oz	1	5.50	5.95	6.50

**Thor Rubber Faced Hammer**  
10oz



- Aluminium-alloy head.
- Fitted with one hard black and one soft red flat rubber push-on face.
- Ash handle.

CODE	Description	Unit	4+	1+
THO612JNR	1½" x 10oz	1	13.25	13.95

**Spare Hide Faces**

CODE	Description	Unit	1+
THO114HD1	1¼"	1	5.50
THO112HD2	1½"	1	6.75
THO134HD3	1¾"	1	8.50
THO200HD4	2"	1	11.25

**Spare Copper Faces**

CODE	Description	Unit	1+
THO114CP1	1¼"	1	5.50
THO112CP2	1½"	1	7.50
THO134CP3	1¾"	1	10.50
THO200CP4	2"	1	15.95

**Dead Blow Mallet**  
2lb/900g



- Mallets have a hollow head which is partially filled with lead-shot, 2lb/900g weight.
- Shot dampens the rebound giving an effective and forceful blow.
- Rubber faces prevent damage to work-piece.

CODE	Description	Unit	6+	1+
DBM05024Z	2lb/900g	1	6.95	7.95

**Thor Bossing Mallet**  
280g



- Ultra-high molecular weight Polythene head for durability.
- Resistant to corrosion and chemicals.
- For dressing lead and metal shaping.
- Head diameter 60mm, head length 125mm, weight 280g.

CODE	Description	Unit	6+	1+
THO899BSS	60mm	1	28.50	29.95

**Thor Nylon Faced Hammer**



- Patented metal head.
- Replaceable screw-in nylon faces.
- Oval plastic handle.

CODE	Description	Unit	4+	1+
THO710114	1¼"	1	15.95	17.50
THO712112	1½"	1	19.25	19.95
THO714134	1¾"	1	22.00	23.25
THO716200	2"	1	29.75	30.95

**Spare Nylon Faces**

CODE	Description	Unit	1+
THO710SNF	1¼"	1	2.75
THO712SNF	1½"	1	2.95
THO714SNF	1¾"	1	3.95
THO716SNF	2"	1	5.25

Punches

## Centre Punch Set 4"

5 Piece



- The centre punches have ground points and knurled grips.
- 1/16" to 5/32" diameter.

CODE	Description	Unit	4+	1+
CPN5PCSET	Centre Punch Set	5 Piece	8.50	9.50

## Centre Punch 3/16"



- Hardened and ground with a knurled grip.
- Point size 3/16"/4mm.

CODE	Description	Unit	20+	10+	1+
PUN316CNT	Centre Punch	1	2.25	2.75	3.00

## Maun Wad Punch Kit Metric

9 Piece



- A very useful tool for cutting washers in leather, fibre, card, felt, rubber etc.
- High grade alloy construction.
- Self centring holder with interchangeable punches.
- Quality product made in Britain.
- Sizes: 5, 6, 8, 10, 12.5, 16, 20, 25 and 32mm.

CODE	Description	Unit	1+
MAU1000ME	Maun Wad Punch Kit	9 Piece	75.00

## Pin Punch Set Standard Length

4 Piece



- Drive pin punches have parallel shafts and knurled shanks.
- Overall length 100mm/4".
- 1/16", 3/32", 1/8", 5/32" diameter.

CODE	Description	Unit	1+
PPN4PCSTD	Standard Set	4 Piece	9.75

## Pin Punch Set Long Series 8"

5 Piece



- Drive pin punches have parallel shafts and knurled shanks.
- Overall length 200mm/8".
- 1/8", 3/16", 1/4", 5/16", 3/8" diameter.

CODE	Description	Unit	1+
PPN5PCLNS	8" Set	5 Piece	16.00

## Hand Sheet Metal Punch Kit

7 Piece



- Powerful toggle action punch producing accurate holes in a wide range of materials
- The matching punch and die gives a clean hole in sheet steel - safer and simpler than a drill.
- Will punch up to 16 gauge mild steel.
- Supplied with 7 punches and dies: 3/32", 1/8", 5/32", 3/16", 7/32", 1/4", and 5/32".
- Maximum throat depth 2", fitted with depth stop.

CODE	Description	Unit	2+	1+
SMP101SET	Hand Sheet Metal Punch	7 Piece	55.00	59.50

## Pin Punch Set Standard Length 4"

8 Piece



- Drive pin punches have parallel shafts and knurled shanks.
- Overall length 100mm/4".
- 1/16", 3/32", 1/8", 5/32", 3/16", 7/32", 1/4", 5/16" diameter.

CODE	Description	Unit	1+
PPN8PCSTD	Standard 4" Set	8 Piece	15.75

## Revolving Punch Plier



- Hand operated punch with swivelling head.
- Cuts holes from 5/64" - 3/16" diameter, in card, leather etc.
- Made of nickel plated steel with heat treated punches.

CODE	Description	Unit	6+	1+
RPP600PLR	Revolving Punch Plier	1	5.50	6.75

## Wad Punch Set

9 Piece



- Hardened carbon steel wad punches.
- Suitable for leather, fabric, paper and card.
- Sizes: 2.5, 3, 4, 5, 6, 7, 8, 9, 10mm.

CODE	Description	Unit	4+	1+
PUN900SET	9 Piece Set	1	7.25	8.50

## Marking Stamps



- Made from hardened steel for long life.
- Suitable for marking components, serial numbers and security marking.
- Supplied in strong plastic box.
- Available in either 3mm or 6mm character height.

### Letter Stamps - 27 Punches

CODE	Description	Unit	4+	1+
MKS327LET	3mm Character Height	1	10.00	11.25
MKS627LET	6mm Character Height	1	17.25	18.50

### Number Stamps - 9 Punches

CODE	Description	Unit	4+	1+
MKS309NUM	3mm Character Height	1	5.00	5.50
MKS609NUM	6mm Character Height	1	7.25	8.50

## Pistol Grip Hand Drill



- Enclosed gears.
- Drill chuck capacity 1/4"/6.5mm.

CODE	Description	Unit	4+	1+
HDR650PGH	Pistol Grip Hand Drill	1	13.75	14.50

## Double Pinion Hand Drill



- Double pinions and die-cast wheel.
- Drill chuck capacity 1/4"/6.5mm.

CODE	Description	Unit	4+	1+
HDR140DPN	Double Pinion Hand Drill	1	13.95	15.50

## Push Pin Magnetic



- Hollow barrel with a magnetic plunger.
- Holds and pushes panel pins up to 3mm diameter.
- Comfortable plastic handle.

CODE	Description	Unit	4+	1+
PPM160MAG	Push Pin	1	5.50	5.95

## Nail Punch



- Hardened and ground with a knurled grip.
- Square head to prevent rolling.
- Point size 3mm.

CODE	Description	Unit	20+	10+	1+
PUN300NAL	Nail Punch 3mm	1	2.10	2.25	2.75

## Automatic Centre Punch



- Easily operated by hand – no need for hammering.
- Depth of impression adjusted by turning head.
- Points can be resharpened.
- Knurled body for positive hold.
- Overall length: 4 7/8" (125mm).

CODE	Description	Unit	1+
CNP171AUT	Automatic Centre Punch	1	29.25

## Nail Punch Set 3 Piece



- Nail punch set having a tempered steel core.
- A permanently bonded Elastomer outer grip.
- The long beveled point allows better alignment.
- Colour coded set consists of sizes 0.8, 1.6, and 2.4mm.

CODE	Description	Unit	6+	1+
NPS3PCSET	Nail Punch Set	3 Piece	5.25	6.00

## Precision Tweezers Type AA



- Straight pointed tweezers, 5" long (120mm).

CODE	Description	Unit	10+	1+
PTW5120AA	Type AA	1	2.95	3.25



# Vocational Studies

**General Construction**  
117-118

**Brickwork**  
119-125

**Plastering**  
125-127

**Tiling**  
128

**Painting & Decorating**  
129-135

**Plumbing**  
136-151

**Electrical**  
152-161

**Welding**  
162-164

**Blacksmith & Forging**  
165



### Heavy Duty Cotton Dustsheet



- High quality close weave cotton for superior protection.
- Approx. size 12ft x 9ft.

CODE	Description	Unit	10+	4+	1+
DTS129HDY	Cotton Dustsheet	1	11.25	13.45	14.55

### Standard Black Bucket



- Pouring lip and measure.
- 3 gallon capacity.

CODE	Description	Unit	12+	4+	1+
BUC300BLK	Std Black Bucket	1	2.25	2.55	3.30

### OX Pro 15L Bucket



- The toughest bucket you have ever used or your money back!.
- High rubber content.
- 15L capacity.

CODE	Description	Unit	12+	4+	1+
OXT150PRB	Pro 15L	1	6.50	6.95	7.50

### Refuse Sacks Pack 200 Rubble Sacks Pack 100



- Sacks in thin gauge for refuse or thick gauge for rubble.

CODE	Description	Unit	4+	1+
SCK200REF	Refuse	Pack of 200	14.55	16.30
SCK100RBL	Rubble	Pack of 100	21.10	22.45

### Heavy Duty Yellow Bucket



- Heavy gauge material.
- 3 gallon capacity.

CODE	Description	Unit	12+	1+
BUC300YEL	Heavy Duty Bucket	1	3.30	3.95

### OX Pro 25L Plasterers Bucket



- Heavy duty bucket which can be used for mixing plaster.
- Strong wire handle and plastic carry grip.
- 5 Gallon / 25 Litre capacity.

CODE	Description	Unit	12+	4+	1+
OXT250PLB	Pro 25L	1	14.25	14.95	16.25

### Flexi-tub



- Heavy-duty flexible plastic..
- Three capacities 15, 26 and 42 litre.

CODE	Description	Unit	12+	4+	1+
FLX150TUB	15L	1	4.50	5.05	5.55
FLX260TUB	26L	1	5.50	6.20	6.70
FLX420TUB	42L	1	6.75	7.30	7.80

### Metal Bucket



- Galvanised steel bucket.
- No.12, diameter 10"/250mm.

CODE	Description	Unit	12+	1+
BUC120MTL	Metal Bucket No.12	1	6.95	7.50

### Dustbin



- 90 litre dustbin with carrying handles and lid.
- Now with clips to hold the lid shut.

CODE	Description	Unit	4+	1+
DBN090BLK	Dustbin	1	22.20	24.70

## Wheelie Bin



- Robust design with two wheels.
- Black 240 litre capacity.

CODE	Description	Unit	2+	1+
WBN240BLK	Black	1	75.95	78.70

## Soft Dustpan and Brush Set



- Durable plastic sets with rubber pan lip edge - 22cm wide.
- Available in four colours - Red, Yellow, Green and Blue.

CODE	Description	Unit	12+	1+
DPB101RED	Red	1	2.80	3.65
DPB102YEL	Yellow	1	2.80	3.65
DPB103GRN	Green	1	2.80	3.65
DPB104BLU	Blue	1	2.80	3.65

## Broom, Handle and Stay 18" or 24"



- Soft or stiff broom available in 18" and 24".
- Supplied with handle and stay.

CODE	Description	Unit	10+	4+	1+
BRM181SFT	Soft 18"	1	14.00	14.55	18.55
BRM182STF	Stiff 18"	1	15.25	15.70	19.70
BRM241SFT	Soft 24"	1	15.25	16.05	19.70
BRM242STF	Stiff 24"	1	16.25	17.45	20.80

## Hand Sweeping Brush



- Wooden handled traditional bristle hand brush.
- Narrow brush design allows easy access behind benches, machines and inside cabinets and crevice.
- Overall length: 15in.
- Brush head length: 7in.

CODE	Description	Unit	12+	6+	1+
HSW157BRU	Hand Brush	1	3.00	3.30	4.20

## Bulldozer Large Dustpan and Brush



- Heavy duty dustpan and brush designed for use in a workshop or on site.
- Hand brush filled with stiff and soft PVC flagged bristles to brush up a variety of debris.
- Integrated rubber lip moulds to the floor surface to aid in the collection of finer particles.
- Serrated edges help clean dust and dirt from the hand brush.
- Pan width 285mm.

CODE	Description	Unit	6+	1+
BDZ285DPB	285mm	1	7.95	8.50

## Bulldozer Broom



- Designed to withstand heavy use in the workshop or on site.
- Hand brush filled with stiff and soft PVC flagged bristles to brush up both heavy debris and light dust.
- Available with either a 14" or 24" width head.

CODE	Description	Unit	4+	1+
BDZ140BRM	14"	1	10.95	11.95
BDZ240BRM	24"	1	14.95	16.50

## Wheelbarrow 90L with Pneumatic Tyre or Solid Puncture-Free Tyre



- Heavy duty galvanised 90 litre tray.
- Additional struts for extra strength.
- Tubular frame with pneumatic tyre or tubular frame with solid puncture-free tyre.

CODE	Description	Unit	10+	4+	1+
WHB090PNU	Pneumatic	1	47.95	49.95	55.95
WHB090SLD	Puncture-free	1	57.95	59.95	65.95

## Shovel Wooden Shaft



- Standard No.2 shovel.
- Wooden shaft.

CODE	Description	Unit	12+	4+	1+
SHV201WDN	Wooden	1	15.75	16.80	17.95

## Shovel Steel Shaft



- Standard No.2 shovel.
- Solid steel shaft.

CODE	Description	Unit	12+	4+	1+
SHV202STL	Steel	1	18.75	21.30	24.20

### Brick Bolsters



- Solid forged with hardening cutting edge
- Shock-absorbing hand guard

CODE	Description	Unit	6+	1+
BBL057WGD	57mm	1	5.50	5.95
BBL075WGD	75mm	1	6.50	6.95
BBL100WGD	100mm	1	7.50	8.25

### Cold Chisel



- Solid forged with hardening cutting edge.
- Shock-absorbing hand guard.

CODE	Description	Unit	6+	1+
CCL192WGD	19 x 250mm	1	4.95	5.50
CCL252WGD	25 x 250mm	1	7.95	8.75

### Plugging Chisel with Guard



- Used to remove the mortar and cement from between brick and block work.
- Made from a single, fully forged piece of carbon steel that has been hardened and tempered.
- Shock-absorbing hand guard

CODE	Description	Unit	6+	1+
PLC250WGD	Plugging Chisel	1	4.50	4.95

### Scutch Chisel



- Hardened and tempered forge steel.
- Takes either a scutch or chisel bit.

25 x 200mm

CODE	Description	Unit	6+	1+
SCL225STD	Scutch Chisel	1	4.95	5.50

### Scutch Combs Pack of 25



- Suitable for both the scutch chisel and hammers.
- Toothed design for effective material removal.

25mm Width

CODE	Description	Unit	2+	1+
STC250PAK	Scutch Comb 25mm Pack of 25		19.40	21.30

### Scutch Hammer Single Ended



- Square head with a single grooved end for taking scutch combs or chisel bits.
- Hickory handle.
- Head weight 20oz.

CODE	Description	Unit	10+	5+	1+
HAM280SSH	Single Ended	1	13.75	14.55	17.95

### Scutch Hammer Double Ended



- Similar in shape to a bricklayers hammer but with a double ended grooved end for taking scutch combs or chisel bits.
- Hickory handle.
- Head weight 22oz.

CODE	Description	Unit	10+	5+	1+
HAM220DSH	Double Ended	1	14.25	15.70	18.30

### Brick Hammer 16oz



- Manufactured from hardened and tempered drop forged steel for increased strength and durability.
- Steel tubular shaft for high shock absorption.
- Striking and chisel blade 16oz (450g).

CODE	Description	Unit	12+	4+	1+
HAM160BRK	16oz	1	5.95	6.50	7.50

### Bricklayers' Hammers



- Square end for tapping bricks into place.
- Chisel end for cutting bricks.
- Hickory shaft with 25oz polished head.

CODE	Description	Unit	10+	5+	1+
HAM250BRH	Brick Hammer	1	12.25	13.45	14.55

### OX Pro Brick Hammer



- Forged, one piece steel construction.
- Accurately ground chisel end for clean cutting.
- Non-slip grip handle with shock reduction.
- Precision balanced.
- 24oz.

CODE	Description	Unit	12+	4+	1+
OXT240BRH	24oz	1	28.25	29.50	31.95

## Club Hammer Fibreglass Shaft



- Fibreglass Handle and rubberised grip.

CODE	Weight	Unit	12+	6+	1+
HAM212CHM	2 1/4lb	1	8.95	9.50	9.95

## Sledge Hammer 7lb and 10lb



- Fibreglass shaft with forged steel head and high-grip rubber handle.

CODE	Size	Unit	4+	1+
HAM700SLD	7lb	1	24.50	27.50
HAM100SLD	10lb	1	39.75	42.95

## Floor Scraper



- The steel blade is designed not to damage tiled flooring or laminate and is fitted with fibreglass handles for strength.
- Fibreglass handle: 1400 x 32mm
- Blade size 300mm (12in).

CODE	Description	Unit	4+	1+
SCR120FLR	Floor Scraper - 12"	1	24.45	25.80
SCR120BLD	Spare Blade - 12"	1	7.80	8.95

## Heavy Duty Tipping Skip 500L



- An industrial tripping skip having a hopper body with folded top edges - 500 litre.
- Heavy duty easy action handle complete with safety catch.
- Fitted with heavy-duty safety chain.
- Optional bolt on castors.

CODE	Description	Unit	1+
SKP500TPG	500L	1	Call for Price

## BC350 Bench Saw



- A portable electrical bench saw designed for cutting a range of materials, such as bricks, slabs, and large tiles.
- Powerful, quiet and maintenance-free induction motor, for fast, effective cutting.
- Available in either 110V or 240V.

### 650mm Cut Length

CODE	Description	Unit	1+
BEL351BNS	110V	1	1740.50
BEL352BNS	230V	1	1740.50

## Belle Minimix 150



- A heavy duty mixer designed for professional use. The ideal portable and robust solution for mixing concrete and mortar.
- Mixes a full barrow of concrete or mortar - 90 litre.
- Complete with barrow height swivel and stand.
- Available petrol and electric - 110V or 240V.

CODE	Description	Unit	1+
BEL150PET	Petrol Honda	1	967.95
BEL151ELC	Electric 110V	1	595.00
BEL152ELC	Electric 240V	1	550.00
BEL150RPD	Replacement Drum	1	199.00

## Refina RMR230 Lime Mortar Roller Pan Mixer



- Mill type roller pan mixer with heavy 85kg twin grinding rollers.
- Ideal for training institutions for reworking lime mortars.
- 1.5kw 110v, speed 30rpm.
- Capacity 50-100kg, output 1400kg/hr.
- Please note a 5kva transformer with 32 amp plug is required.
- Size WxLxH 120x150x110cm, weight 320kg.

CODE	Description	Unit	1+
REF230RMR	RMR230	1	4295.00

## Builders External Corner Profiles

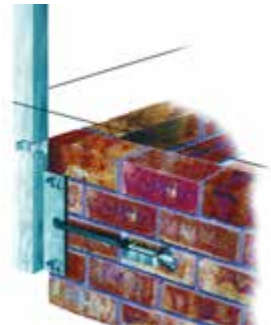

- Labour saving building profile enabling pointing work to be carried out as work progresses.
- Simple to erect and easy to use - complete with instructions.
- Removes the need to raise corners first by providing an accurate corner post.
- Galvanised steel construction.
- Complete kit of profiles, retaining bolts and clamping brackets.

CODE	Description	Unit	2+	1+
BPK001PAK	External Corner Profiles	1	195.95	208.50

## Marshalltown Gatorback Mortar Board



- Water resistant, contour surface designed to keep mortar at optimal workability and consistency.
- Hold up to 70kg of material with little flex.
- Reinforced integrated handles for easy transportation.
- Size: 610mm/24" square.

CODE	Description	Unit	10+	5+	1+
MST024GMB	610mm/24"	1	37.95	39.95	42.95



### Marshalltown Masons Line 87m (285ft)



- Masons line made of Twisted nylon, size 15 - 125 mm core
- Heat-set after winding to stabilize
- Not affected by mortar, oil, or mildew and will not absorb water
- Great for staking out sites, concrete and landscape layout, as well as brick/block laying
- Made in the U.S.A.

CODE	Description	Unit	1+
MST620NML	White	1	5.25
MST621NML	Yellow	1	7.25
MST631NML	Fluorescent Pink	1	8.95
MST632NML	Fluorescent Yellow	1	8.95

### Cardoc Cotton Builders Line Box of 12



- Popular white cotton for brickwork or as a chalkline.
- Supplied as a box of 12 hanks x 18m.

#### 18m Length

CODE	Description	2+	1+
BLN120WCT	Cotton Builders Line	17.50	18.50

### S & J Rubber Blocks and Line Set



- The line is an 8 strand braided nylon brick line that produces a straight line under tension.
- The rubber blocks are angled at 87.5° so that, when under tension, they square up into the corner of the brick for a better grip and a more stable line.
- Rubber surface and grooves prevent slippage whilst in use.
- Highly visible fluorescent colours – easy to see, not so easy to lose

CODE	Description	Unit	4+	1+
SAJ10701S	Blocks and Line	1	7.80	8.95

### OX Pro Cyan Brickline 100m



- Mason's line made of tough twisted nylon.
- Very high quality durable material.
- Cyan colour for high visibility.
- 100mm/328ft.

CODE	Description	Unit	12+	4+	1+
OXT100BLN	Brickline	1	8.50	8.75	9.50

### Footprint Corner Blocks Pair



- Designed by bricklayers and made in Britain.
- Window to see gauge markings on a profile and to check line isn't snagged.
- Narrow channels to hold the line tight.
- Easy to grip, even when wearing gloves.
- 50mm internal sides to fix 50mm box section profiles.

CODE	Description	Unit	12+	4+	1+
FPT624DPR	Corner Block Pair	Pair	3.50	3.95	4.95
FPT624PAK	Corner Block Pair	Pk 18 Pairs			49.50

### Marshalltown M86P Plastic Line Blocks Pack of 2 Pairs



- Plastic brick line blocks used instead of line pins when laying bricks.

CODE	Description	Unit	6+	1+
MST086PLB	Line Blocks	Pack of 2	6.25	6.50

### Cardoc Poly Builders Line Box of 12



- Standard orange polyethylene builders line.
- Supplied as a box of 12 hanks x 18m.

#### 18m Length

CODE	Description	2+	1+
BLN120PLY	Cardoc Poly Builders Line	9.95	10.75

### Beech Line Block Pack of 2



- Pair of beech brick line block.
- Used instead of line pins.

CODE	Description	Unit	6+	1+
LBK200BEC	Line Blocks	Pack of 2	2.25	2.50

### Marshalltown Line Blocks Pack of 2



- Pair of hardwood brick line block.
- Used instead of line pins.

CODE	Description	Unit	6+	1+
MST860LBK	Line Blocks	Pack of 2	2.90	3.10

## S & J Line and Pins Set



- Cast metal pins for extended life.
- 30m high visibility line.

CODE	Description	Unit	4+	1+
SAJ10505Z	Line and Pins	1	6.45	7.05

## OX Pro Line Pins Pack of 2



- Made from solid forged carbon steel for ultimate strength.
- Taper ground point and edges - drives easily into the wall.
- Chrome plated for fine finish, extra wear resistance and rust prevention.
- 6"/152mm length.

CODE	Description	Unit	12+	4+	1+
OXT602LPN	Line Pins	Pack of 2	7.25	7.75	8.25

## Footprint Steel Line Pin 620



- Original manufacturer of this traditional product
- Drop forged, hardened and chrome plated line pins
- Supplied loose in singles.

CODE	Description	Unit	6+	1+
FPT620LPN	Line Pin	1	3.65	4.45

## Marshalltown Brick Jointer



MST800JTR

MST820JTR

MST810JTR

- For striking concave joints.
- Hardened blade.
- Double ended.
- Three sizes available.

CODE	Description	Unit	10+	1+
MST800JTR	1/2 x 5/8"	1	7.95	8.50
MST820JTR	5/8 x 3/4"	1	7.95	8.50
MST810JTR	3/4 x 7/8"	1	7.95	8.50

## OX Pro Brick Jointer



- For a professional finish to joints between bricks.
- Heavy duty design.
- High quality steel.
- Sizes clearly engraved onto tool.
- 1/2" x 5/8".

CODE	Description	Unit	4+	1+
OXT125JTR	1/2" - 5/8"	1	5.75	6.25

## S & J Brick Jointer



- For smooth finishing of bricks, 1/2" - 5/8".
- Heavy steel construction.

CODE	Description	Unit	4+	1+
SAJ12158B	Brick Jointer	1	3.30	3.65

## Marshalltown Brick Joint Raker No.89



- Strong aluminium handle is contoured to fit the hand and squared off at the end.
- Two large hardwearing wheels and replaceable point.
- Size 8 1/2" x 3".

8 1/2" x 3in

CODE	Description	Unit	6+	1+
MST890BJR	Brick Jointer Raker	1	14.50	15.25

## Marshalltown Pointing Trowel 5" or 6" Philadelphia



- Marshalltown philadelphia pattern pointing trowel.
- Forged Blade.
- End Tamper.
- Ground for balance.

CODE	Description	Unit	10+	5+	1+
MST455PTT	Pointing Trowel 5"	1	18.50	19.25	20.25
MST456PTT	Pointing Trowel 6"	1	18.50	19.25	20.25

## Marshalltown Brick Trowel 10" or 11" Philadelphia



- Marshalltown philadelphia pattern brick trowel with durasoft handle.
- Finger Guard.
- Forged Blade.
- End Tamper.
- Ground for balance.

CODE	Description	Unit	10+	5+	1+
MST910BRT	Brick Trowel 10"	1	53.95	55.75	58.95
MST911BRT	Brick Trowel 11"	1	53.95	55.75	58.95

**OX Pro Margin Trowel**  
5"



- High quality carbon steel flat rectangular blade.
- Duragrip handle for extreme comfort.
- Precision tapered ground blade.
- 5" x 2" blade size.

CODE	Description	Unit	12+	4+	1+
<b>OXT005MGT</b>	Margin	1	<b>9.50</b>	9.95	10.75

**OX Pro Pointing Trowel**  
5" or 6" Philadelphia



- High quality carbon steel.
- Duragrip handle with finger protection for extreme comfort.
- Straight welded shank.
- Available in either 5" or 6" blade size.

CODE	Description	Unit	12+	4+	1+
<b>OXT005PTT</b>	5" Philadelphia	1	<b>9.95</b>	10.50	11.25
<b>OXT006PTT</b>	6" Philadelphia	1	<b>9.95</b>	10.50	11.25

**OX Pro Gauging Trowel**  
7"



- High quality carbon steel.
- Duragrip handle with finger protection.
- Well balanced and perfect flexibility.
- 7" blade size.

CODE	Description	Unit	12+	4+	1+
<b>OXT007GGT</b>	Gauging	1	<b>12.95</b>	13.75	14.75

**OX Pro Brick Trowel**  
10" or 11" Philadelphia



- Solid forged steel blade for ultimate strength.
- Duragrip handle with finger protection for extreme comfort.
- Precision tapered ground blade, well balanced and perfect flexibility.
- Hard end handle for tapping in bricks.
- Available in either 10" or 11" blade size.

CODE	Description	Unit	12+	4+	1+
<b>OXT010BRT</b>	10" Philadelphia	1	<b>32.95</b>	34.75	37.50
<b>OXT011BRT</b>	11" Philadelphia	1	<b>33.75</b>	35.50	38.25

**OX Pro Pointing Trowel**  
5" or 6" London



- High quality carbon steel.
- Duragrip handle with finger protection for extreme comfort.
- Straight welded shank.
- Available in either 5" or 6" blade size.

CODE	Description	Unit	12+	4+	1+
<b>OXT905PTT</b>	5" London	1	<b>9.95</b>	10.50	11.25
<b>OXT906PTT</b>	6" London	1	<b>9.95</b>	10.50	11.25

**OX Pro Tuck Pointer**



- One piece high quality carbon steel blade.
- Duragrip handle with finger protection.
- Soft grip handle for extreme comfort.
- Overall length 172mm
- 8mm or 10mm width.

CODE	Description	Unit	12+	4+	1+
<b>OXT008TUC</b>	8mm	1	<b>7.50</b>	7.95	8.95
<b>OXT010TUC</b>	10mm	1	<b>7.50</b>	7.95	8.95

**OX Pro Brick Trowel**  
11" London



- Solid forged steel blade for ultimate strength.
- Duragrip handle with finger protection for extreme comfort.
- Precision tapered ground blade, well balanced and perfect flexibility.
- Hard end handle for tapping in bricks.
- 11" blade size.

CODE	Description	Unit	12+	4+	1+
<b>OXT911BRT</b>	11" London	1	<b>33.75</b>	35.50	38.25

**OX Pro Bucket Trowel**  
7"



- High quality carbon steel.
- Duragrip handle with finger protection.
- Heavy duty straight shank.
- 7" blade size.

CODE	Description	Unit	12+	4+	1+
<b>OXT007BKT</b>	Bucket	1	<b>9.95</b>	10.50	11.25

**OX Pro Brick Joint Raker**



- Designed for clearing out mortar from between brickwork prior to pointing.
- Strong aluminium handle contoured to fit the hand.
- Two hardwearing wheels and replaceable point.
- 8½" X 3".

CODE	Description	Unit	12+	4+	1+
<b>OXT003BJR</b>	Raker	1	<b>10.75</b>	11.25	12.25

## S & J Brick Trowel 11" Philadelphia



- 11" Philadelphia Trowel.
- Weatherproofed hardwood handle.

CODE	Description	Unit	12+	4+	1+
SAJ10511P	Philadelphia 11"	1	4.75	5.05	7.05

## S & J Philadelphia Brick Trowel 11" Philadelphia



- Philadelphia blade for added balance.
- Integrated finger guard.

CODE	Description	Unit	10+	5+	1+
SAJ611PSF	Philadelphia 11"	1	11.75	12.30	13.45

## S&J Gauging Trowel 7"



- Medium sized trowel with a large radius.
- Soft grip handle with integrated finger guard.

CODE	Description	Unit	10+	5+	1+
SAJ607GSF	Gauging Trowel 7"	1	8.50	8.95	10.05

## S & J Brick Trowel 6" Pointing



- 6" Pointing Trowel.
- Weatherproofed hardwood handle.

CODE	Description	Unit	12+	4+	1+
SAJ10506P	Pointing Trowel	1	2.50	2.65	4.20

## S & J Broad Heel Brick Trowel 10" or 11"



- Broad blade allows extra capacity for mortar.
- Integrated finger guard.
- Available in 10 and 11".

CODE	Description	Unit	12+	5+	1+
SAJ610BSF	Broad Heel 10"	1	10.75	11.20	12.65
SAJ611BSF	Broad Heel 11"	1	11.75	12.30	13.45

## S&J Bucket Trowel 7½"



- Medium sized trowels with cropped end.
- Soft grip handle with integrated finger guard..

CODE	Description	Unit	10+	5+	1+
SAJ565BSF	Bucket Trowel 7½"	1	10.75	11.20	12.30

## Tuck Pointer Wooden or Soft Grip Handle



- Perfect for filling masonry joints with mortar in difficult areas.
- Hardwood or soft grip handle.

CODE	Description	Unit	12+	4+	1+
TUC010WDN	10mm Wooden	1	2.95	3.50	3.95
TUC010SGP	10mm Soft	1	4.75	5.50	5.95

## S & J Pointing Trowel 5" or 6"



- Integrated finger guard.
- Available in 5" and 6".

CODE	Description	Unit	10+	5+	1+
SAJ605PSF	Pointing Trowel 5"	1	6.25	6.45	7.05
SAJ606PSF	Pointing Trowel 6"	1	7.00	7.30	8.45

## WHS Tyzack Brick Trowels 10" or 11" Philadelphia



- Solid forged - for extra strength.
- High lift for extra knuckle clearance.
- Hardened and tempered for the correct balance.
- Philadelphia pattern taper ground, thin to toe - increased flexibility.
- Available in 10" or 11" blade length.

CODE	Description	Unit	10+	5+	1+
SAJ0710SF	Philadelphia 10"	1	28.00	29.20	33.70
SAJ0811SF	Philadelphia 11"	1	28.00	29.20	33.70

**Ragni Brick Trowel**  
11" Philadelphia



- Ragni Philadelphia pattern 11" brick trowel.
- 1.6mm carbon steel.
- Allows more mortar to be placed on blade.
- Soft grip comfortable handle for long hardwearing performance.
- Thickened steel tang diameter for greater strength.
- High lift tang for better knuckle clearance.

CODE	Description	Unit	12+	6+	1+
<b>BRC110PTS</b>	Trowel 11"	1	15.25	15.70	16.30

**Marshalltown No.88**  
Brick Tongs



- Adjustable Brick Tongs which enable the user to carry 6 to 10 bricks at a time.
- All steel construction.

CODE	Description	Unit	10+	5+	1+
<b>MST880BTG</b>	Brick Tongs	1	29.75	30.75	32.50

**OX Pro Aluminium Hawk**

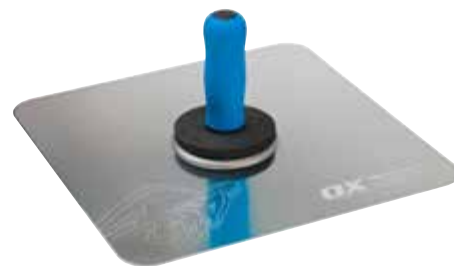

- High quality tempered aluminium blade.
- Sponge rubber blister preventer.
- Machined surface of blade to stop mortar from sliding off.
- 13" x 13".

CODE	Description	Unit	12+	4+	1+
<b>OXT330HWK</b>	13" x 13"	1	28.95	30.50	32.95

**Ragni Brick Trowel**  
11" London



- Ragni London pattern 11" broad heel brick trowel.
- Top quality 1.6mm thick steel blade.
- Soft grip comfortable handle.
- Tempered and hardened ground blade applies mortar easily.
- Excellent knuckle clearance.

CODE	Description	Unit	12+	6+	1+
<b>BRC110LTS</b>	London Trowel 11"	1	15.25	15.70	16.30

**Folding Squares**



- Aluminium folding frame which locks to provide 90° and 45°.
- Available in either 600mm/24" or 1200mm/48".

CODE	Size	Unit	10+	5+	1+
<b>FSQ240ALU</b>	600mm/24"	1	14.95	15.75	16.95
<b>FSQ480ALU</b>	1200mm/48"	1	32.25	33.75	36.50

**Marshalltown Plasters Hawk**



- M1 Marshalltown Plasterers Hawk, Durasoft Handle.
- Callous Preventer.
- Scored Blade.
- 13" x 13" (325 x 325mm).

CODE	Description	Unit	12+	4+	1+
<b>MST100HWK</b>	Plasterers Hawk	1	33.95	34.95	36.95

**Ragni Pointing Trowel**  
6" London



- Ragni London pattern 6" pointing trowel.
- Soft grip handle.

CODE	Description	Unit	12+	6+	1+
<b>BRC060PTS</b>	Pointing Trowel 6"	1	10.00	10.70	10.95

**Large Steel Square**



- Large steel square.
- Blade finish with white marking.

**600mm x 400mm**

CODE	Description	Unit	10+	5+	1+
<b>LSS640STL</b>	Large Steel Square	1	6.95	7.75	8.50

**Aluminium Hawk**



- Made from rolled aluminium with smooth, straight edges and rounded corners.
- Detachable handle.
- 13" x 13" (325 x 325mm).

CODE	Description	Unit	12+	4+	1+
<b>HWK122ALU</b>	Aluminium Hawk	1	14.25	15.25	16.95

## Polyurethane Hawk



- Made from lightweight moulded polyurethane.
- 13" x 13" (325 x 325mm).

CODE	Description	Unit	12+	4+	1+
HWK132PLY	Polyurethane Hawk	1	14.00	14.55	15.70

## WHS Tyzack Finishing Trowels Ready to Go 11" or 13"



- Stainless steel blade cross ground for easy material flow and tension rolled to ensure consistent blade shape
- Ready to Go means pre-worn edges and rounded edges to eliminate ripple marks and prevent digging in
- Stainless rivets for longer life and added strength.
- Soft feel handle for comfort.

CODE	Description	Unit	10+	5+	1+
SAJ1158SF	Plastering Trowel 11"	1	24.75	26.15	33.70
SAJ1358SF	Plastering Trowel 13"	1	25.95	26.95	29.25

## Marshalltown Plasterers Float 13"



- MXS13D Marshalltown 13in (325mm) Plasterers Trowel with Durasoft Handle.
- Highest grade hardened and tempered blade.
- Aluminium alloy Xtralite mounting, lightweight and strong.
- Beveled work edges prevent surface aggregate popping.
- For plastering and finishing work.

CODE	Description	Unit	12+	4+	1+
MST135FFL	Plasterers Float	1	43.75	45.25	47.75

## Polyurethane Float



- For use in concrete flooring, this float is lightweight and easy to clean.
- Non absorbent patterned face.
- Can be nailed for scoring.

### 280mm

CODE	Description	Unit	12+	4+	1+
FLT280PLY	Plastic Float 280mm	1	5.00	5.35	6.20

## Ragni Plastering Pro Trowel 11"



- Ragni plasterers finishing trowel - 06 gauge blade.
- Straight grained 11" x 4 3/4" (28cm x 12cm).
- Stem 23cm handle abs plastic.

CODE	Description	Unit	12+	6+	1+
PLT110TWP	Plastering Trowel 11"	1	15.50	15.70	16.80

## OX Pro Plasterers Trowel Stainless Steel



- High quality tempered stainless steel blade.
- Pre-worn edges to eliminate line and ripple marks.
- Duragrip handle for ultimate comfort and set for perfect balance.
- Lightweight aluminium shank - fully riveted.
- 11" x 4 1/2".

CODE	Description	Unit	12+	4+	1+
OXT011PLT	11"	1	31.75	33.25	35.95

## S & J Finishing Float 11"



- Lightweight strong die cast aluminium tang.
- Stainless rivets for longer life and added strength.
- Soft feel handle for extra comfort.

CODE	Description	Unit	12+	4+	1+
SAJ011CSF	Finishing Float	1	9.95	10.70	12.30

## Ragni Plastering Pro Trowel 13"



- Ragni plasterers' finishing trowel - straight grained.
- Steel float - carbon steel blade.
- 13" x 4 3/4" (33cm x 12cm) stem 23cm.
- ABS plastic handle.

CODE	Description	Unit	12+	6+	1+
PLT130TWP	Pro Trowel 13"	1	18.25	19.05	19.70

## OX Pro Internal Corner Trowel

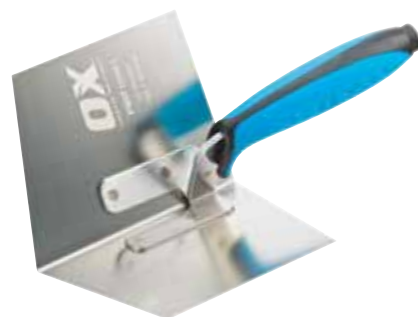

- Flexible stainless steel blade.
- Strong aluminium mounting.
- Duragrip handle for extreme comfort.
- Flexes for perfect 90° corners.
- 4" x 5".

CODE	Description	Unit	12+	4+	1+
OXT405CRT	Internal	1	11.25	11.75	12.75

### Speedskim



- Speedskim is the new and revolutionary tool system designed to increase metreage output and enhance quality of finish at the same time significantly reducing the harmful effects of fatigue and RSI.
- Flattening, finishing and ruling off.
- Compatible with all gypsum based plasters (hand and spray applied), traditional sand and cement renders and insulated rendering systems.
- Complete with integral blade guard.

#### 600 or 1200mm Width

CODE	Size	Unit	12+	4+	1+
SKM600RUL	ST 600mm	1	51.95	54.50	58.75
SKM120RUL	ST 1200mm	1	66.25	69.25	74.75

### Marshalltown Plaster Darbie



- Marshalltown 48" Plaster Darbie M14884 has a magnesium double side blade with dual raised edges to increase strength and durability.
- 48" blade tapers from 3 1/2" to 2" / 88mm to 50mm.
- Twin wooden handles.

#### 48" Blade

CODE	Description	Unit	12+	4+	1+
MST148DRB	Plaster Darbie	1	47.95	49.50	52.25

### Long Straight Edge



- The combined feather edge and straight edge is made from extruded mill finished aluminium which is exceptionally light and manoeuvrable.
- Metric scale, graduated at 5mm intervals and numbered every 50 mm.
- Section: 93 x 25mm (3 5/8 x 1 in).

#### 1800mm (6ft) Length

CODE	Description	Unit	12+	4+	1+
STE180ALU	Long Straight Edge	1	42.95	44.95	49.50

### OX Plasterer's Small Tool



- For fine finishing of plaster and cement.
- High quality carbon steel.
- One piece drop forged.
- Precision ground and tempered.
- 13mm square end.

CODE	Description	Unit	12+	4+	1+
OXT130SMT	13mm	1	9.95	10.50	11.25

### Drywall Rasps



- Drywall Rasps available with or without guide rails.
- Durasoft handle for comfort.
- Stainless steel blade that works in both directions.
- Size: 140mm (5.1/2in).

CODE	Size	Unit	1+
MST389DWR	DR389 with Guide Rail	1	13.50
MST390DWR	DR390 without Guide Rail	1	12.95

### OX Trade Jab Saw & Holster



- Hardened and tempered steel blade for increased life.
- Non-slip ergonomic handle.
- Excellent for wood, plastic and drywall.
- Supplied with protective holster for safety when not in use.
- Blade 165mm x 8tpi.

CODE	Description	Unit	12+	4+	1+
OXT165JBS	Jab Saw	1	10.50	10.95	11.75

### Plasterer's Mixing Paddle



- Suitable for paint, adhesives and fillers.
- The paddle can mix liquids between 10 - 20kg.
- Mixing head 100mm with a 10mm hex shank.
- Max speed: 40 - 60rpm.

#### 590mm Length

CODE	Description	Unit	4+	1+
MPD100HEX	Mixing Paddle	1	3.95	4.20

### Refina/Eibenstock MM19 Megamixer



- Guaranteed German made mixer with a heavy duty 1000w 110v motor and long life gearbox.
- Back and hoop handle mixer for easy handling.
- Soft start - low splash with variable speed.
- High torque and slow speed 450rpm, for heavy materials.
- Supplied with a MR3 130G 5" paddle.
- Capacity 25-50kg, output 400kg/hr.

CODE	Description	Unit	2+	1+
REF019MMR	MM19	1	219.75	230.00

### Refina/Eibenstock MM30 Megamixer

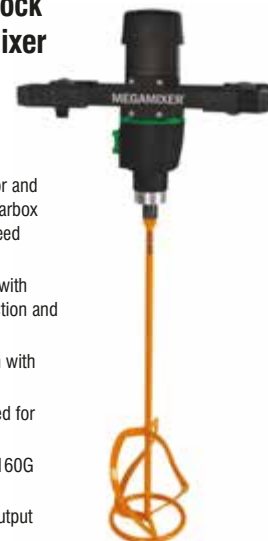

- Powerful 1800w motor and long life two speed gearbox 250/580rpm, guaranteed German made mixer.
- New H handle design with improved cable protection and switch dust cover.
- Soft start - low splash with variable speed.
- High torque/slow speed for powerful mixing.
- Supplied with a MR3 160G 6 1/4" paddle.
- Capacity 50-100kg, output 1200kg/hr.

CODE	Description	Unit	2+	1+
REF030MMR	MM30	1	380.95	399.00

Tiling

## Tiling Trowel



- Designed for hard wearing performance, comfort and ease of use.
- 6mm square notches
- Hardened and tempered steel blade ensures toughness and durability
- Large soft-grip handle provides extra comfort.
- Blade 115 x 280mm.

CODE	Description	Unit	6+	1+
VTX116TTW	Tiling Trowel	1	9.95	10.75

## Tile Nipper



- Tile cutting pliers with tungsten carbide-tipped jaws and sprung handles.
- Overall length 210mm.

CODE	Description	Unit	4+	1+
TNP210TCT	Nipper	1	8.95	9.75

## Grouting Float



- Gum Rubber Grout Float with a heavy-duty backing plate.
- Lightweight cellulosed core with bevelled sides.
- ABS handle.
- Size: 9" x 4".

CODE	Description	Unit	6+	1+
TLR940GFL	Grouting Float	1	10.70	11.80

## Heavy Duty Hand Tile Cutter



- Heavy-duty flat bed tile cutter with a rigid steel construction and integral angle cutting guide.
- Cuts ceramic wall and floor tiles up to 500mm square and 12mm thick, diagonal cuts are also possible on tiles up to 360 mm square.

CODE	Description	Unit	6+	1+
VTX500HTC	HD Tile Cutter	1	29.95	34.95

## Tile Cutter Professional



- Professional and powerful tilting table top tile saw, that is perfect for a mitre cut from 0° to 45°. It is easily transportable with its protecting case.

Input Power	800 Watt./240V
No Load Speed	2950/min.
Blade	Diamond 200 x 25.4mm
Tilting head / table	0-45°
Cutting depth	90°: 40mm, 45°: 20mm
Table size	460 x 360mm
Dimensions (L x W x H)	510 x 400 x 230mm
Weight	16kg

CODE	Description	Unit	1+
CLP800PTS	Tile Cutter	1	235.00

COMING SOON

## Rubi Tile Cutting Equipment



See [www.tilgear.co.uk](http://www.tilgear.co.uk) for more information

## Tile Spacers Pack of 1000



- Plastic tile spacers in a pack of 1000.
- Available in either 1.5mm or 2.5mm leg size.

CODE	Description	Unit	6+	1+
TLS150PAK	1.5mm Leg Pack of 1000	Pack of 1000	8.25	8.50
TLS250PAK	2.5mm Leg Pack of 1000	Pack of 1000	8.50	8.95

## Tiling Super Sponge



- Heavy-duty extra large premium sponge suitable for everything from tiling and grouting clean-up to plastering and drywall wipe down.
- The unique hydrophilic design holds up to 4 times more liquid than standard sponges and the rounded edges minimise digging out or marring of grout.
- Size 75 x 115 x 50mm.

CODE	Description	Unit	12+	6+	1+
TSS200EXL	Super Sponge	1	4.25	4.50	4.95

## Tile File



- Half round/flat file for ceramic tiles, plaster etc.
- Tungsten carbide grit welded to a mild steel blank.
- Cuts in any direction.
- Cutting length 150mm.

CODE	Description	Unit	4+	1+
TFL150TCB	File	1	7.25	7.95



### Pure Badger Hair Softener Brush



- Used to soften and blend coloured glaze for sophisticated decorative painting techniques such as marbling and wood graining.
- Finest pure badger bristle and high quality hardwood handle.
- Available in 50mm (2"), 75mm (3") and 100mm (4") widths.

CODE	Description	Unit	2+	1+
SBR200PBS	50mm/2"	1	33.50	35.75
SBR300PBS	75mm/3"	1	43.25	45.95
SBR400PBS	100mm/4"	1	55.50	58.95

### Thin Flat Badger Hair Brush



- High quality badger hair.
- Ideal for small areas.

CODE	Description	Unit	2+	1+
SBR200FBB	Flat Brush - Thin	1	15.25	16.25

### Triangular Graining Comb



- Fine, medium and coarse teeth on each side.
- Made from rubber.

CODE	Description	Unit	2+	1+
SFE111TGC	Triangular Graining Comb	1	5.95	6.50

### Overgrainer Graining Brush



- A comb is passed through the Overgrainer when it's charged with paint, separating the bristles.
- Pencils of bristle re-create the parallel overgrain lines.

CODE	Description	Unit	2+	1+
SBR200OGB	Graining Brush 2"	1	6.75	7.25
SBR300OGB	Graining Brush 3"	1	7.25	7.75

### Thick Ferrule Fan Overgrainer



- Useful to replicate certain grain patterns
- Bristles can be separated into pencils.

CODE	Description	Unit	2+	1+
SBR373FOG	Thick Ferrule	1	14.75	15.75

### Dragging Brush 2 Row Nylon Bristle



- Dragged through a glaze, this brush will give the impression of basic grain.
- The two rows of pure bristle give lighter textured effect.

CODE	Description	Unit	2+	1+
SBR377DBR	2 Row Nylon Bristle	1	20.75	21.95

### Hog Hair Pencil Grainer



- Hog hair pencils set into a wooden block
- Ideal for creating widely spaced lines

CODE	Description	Unit	2+	1+
SBR200PGH	Hog Hair 2"	1	10.75	11.50
SBR300PGH	Hog Hair 3"	1	12.95	13.75

### Round Badger Hair Brush Size 6



- High quality badger hair.
- For marbling and blending.

CODE	Description	Unit	2+	1+
SBR600RBB	Hair Brush - Size 6	1	4.70	4.95

### Pure Bristle Flogger



- Thin brush with bristles approx. 5½" long.
- Used to hit (flog) wet glaze or stain to produce the pore effect found in hardwoods.
- Can also be used as a dragging brush.

CODE	Description	Unit	2+	1+
SBR300FLG	Pure Bristle Flogger 3"	1	20.50	21.75
SBR400FLG	Pure Bristle Flogger 4"	1	21.95	23.50

## Plastic Grainer with handle



- Use to simulate heart grain of softwoods.
- The formed plastic combs are rocked to create the effect.

CODE	Description	Unit	2+	1+
SFE122PGR	Plastic Grainer with handle	1	5.25	5.50

## Double Ended Fine Heart Grainer



- Use to simulate a thinner heart grain effect.
- Double ended 3.5" and 4.5" widths.

CODE	Description	Unit	2+	1+
SFE144FHG	Grainer Double Ended	1	12.95	13.95

## Prodec Painters Dozen 12 Piece



- A quality brush pack, with a good mix of sizes, suitable for most painting tasks.
- 12 piece pack contains 2 x 1", 5 x 1½", 4 x 2", & 1 x 3"

CODE	Description	Unit	4+	1+
DEC120SET	Painters Dozen Set 12 Piece		16.30	17.15

## Natural Sponge



- Best quality 'wool' sea sponge.
- Approximately 5" - due to it being a natural product.

CODE	Size	Unit	10+	5+	1+
SFE500SPG	Approximately 5"	1	3.60	3.70	3.95

## Double Ended Wipe-Out Tool



- Double ended with shaped rubber ends
- Used to wipe-out when graining

CODE	Description	Unit	2+	1+
SFE133WOT	Wipe-Out Tool Double Ended	1	2.80	2.95

## Graining Comb Set 12 Piece



- 4 widths in 3 different grades
- Fine, medium and coarse.

CODE	Description	Unit	2+	1+
SFE120GCS	Graining Combs Set 12 Piece		46.95	49.95

## Purdy Monarch Elite Brush Sets



- This renowned manufacturer has offered a superb deal on selected boxed sets of their most popular Monarch Elite brush range.
- Thick stock makes it suitable for both water and oil based paint.
- Designed by UK Professionals for UK professionals.
- Handmade in USA.

**Set No.1:** Three brushes 1", 1½", & 2"

**Set No.3:** Three brushes 1½", 2" & 3"

CODE	Description	Unit	1+
PUR103SET	Monarch Elite Brush Set No.1	1	33.70
PUR303SET	Monarch Elite Brush Set No.3	1	44.70

## Diamond Synthetic Brush



- Synthetic filament for a smooth finish.
- American style wooden handle.

CODE	Description	Unit	12+	6+	1+
BRU100DMD	25mm/1"	1	1.50	1.80	2.10
BRU112DMD	38mm/1½"	1	2.25	2.65	3.30
BRU200DMD	50mm/2"	1	4.00	4.45	5.05
BRU300DMD	75mm/3"	1	4.75	5.05	5.90

## Diamond Brush Set 5 Piece



- Synthetic filament for a smooth finish.
- American style wooden handle.
- Brush set comprising 2 x 1", 2 x 1½" and 1 x 2."

CODE	Description	Unit	4+	1+
BRU500DMD	Diamond Brushes Set 5 Piece		10.05	11.20

Pro Brushes



- High quality 100% pure black bristle brushes.
- Stainless steel ferrules with burgundy handles

CODE	Size	Unit	6+	1+
PBR120PK1	½"	1	0.50	0.60
PBR100PK1	1"	1	0.90	0.95
PBR112PK1	1½"	1	1.30	1.45
PBR200PK1	2"	1	1.95	2.10
PBR300PK1	3"	1	3.95	4.45
PBR400PK1	4"	1	4.45	5.05

Paste Brush



- Extra wide polyester and pure bristle easy flow paste brush.
- Maroon textured plastic handle with a non-rust ferrule.
- Size 6"/150mm.

CODE	Size	Unit	6+	1+
BRU150PST	6"/150mm	1	10.70	11.20

Stencil Brush No12



- Pure grey bristle ¾".
- Wooden handle with spun metal ferrule.

CODE	Size	Unit	4+	1+
BRU120STN	¾"	1	3.95	4.20

Economy Brushes  
Packs of 12 or 48



- An excellent investment to cover all eventualities. Ideal for painting, varnishing, gluing etc.
- Assorted pack includes 12 of each size.

CODE	Size	Unit	10+	4+	1+
EBR120P12	½"	Pack of 12	4.50	5.35	5.90
EBR100P12	1"	Pack of 12	6.50	7.25	7.95
EBR112P12	1½"	Pack of 12	7.50	8.50	9.95
EBR200P12	2"	Pack of 12	10.95	12.50	13.95
EBRPACK48	Assorted Sizes	Pack of 48	38.20	40.45	

Paste Block Brush



- High capacity block brush featuring a soft grip handle for added comfort when in use.
- Ideal for pasting all wallpapers and covering with minimum effort. Suitable for use with all types of wallpaper paste.
- Size 120mm wide x 30 mm thick.

CODE	Description	Unit	6+	1+
BRU120PST	Paste Block Brush	1	6.20	6.70

Paperhanging Brush



- Pure bristle paperhanging brush.
- For use with all wall coverings.

CODE	Size	Unit	4+	1+
BRU700PHG	7"	1	4.45	5.05

Disposable Brushes  
Pack of 10



- Popular disposable brushes ideal for odd gluing, painting and swarf removal jobs.
- The long soft bristles can be cut short to provide a stiff brush suitable for cleaning threads, small components etc.
- Round wooden handle.

CODE	Size	Unit	5+	1+
DBR120P10	½"	Pack of 10	4.50	4.95
DBR340P10	¾"	Pack of 10	6.95	7.95

Dusting Brush



- A professional soft grey bristle brush, that moves dust rather than flicking it.
- Size: 4"/100mm.

CODE	Size	Unit	4+	1+
BRU100DUS	4"/100mm	1	8.15	8.95

Pro Paperhanging Brush



- A quality paperhanger's brush mounted on a contoured wooden stock for easier handling and better grip.
- Size: 9"/230mm.

CODE	Description	Unit	4+	1+
BRU900PPH	9"	1	12.10	13.45

## Paint Roller and Tray



- Handle and roller - width 9"/225mm x 1.5" diameter.
- Plastic paint tray.

CODE	Size	Unit	4+	1+
PRT900SET	9"/225mm x 1 1/2"	1	3.50	3.80

## Tiger Stripe Roller Kit Medium Pile



- Trade quality woven acrylic refill, with push fit frame and black plastic tray.
- Roller width 9"/225mm x 1.75" diameter.

CODE	Size	Unit	4+	1+
PRT225KIT	9"/225mm x 1.75"	1	5.90	6.45

## Filling Blades Pack of 4



- Pack of 4 flexible steel blades with plastic handles for small mixing and filling jobs on walls, ceilings and woodwork.
- Contains one each of the following 120mm, 100mm, 80mm and 50mm wide blades.

CODE	Description	Unit	4+	1+
FLB400PAK	Filling Blades Pack of 4	1	2.50	2.95

## Spare Roller Sleeves



- Medium density polyester refill to suit PRT900SET.
- Roller width 9"/225mm x 1.5" diameter.

CODE	Size	Unit	4+	1+
PRT900SLV	9"/225mm x 1.5"	1	1.45	1.50

## Spare Tiger Stripe Roller Sleeves Medium Pile



- Medium pile woven sleeves to suit PRT225KIT.
- Roller width 9"/225mm x 1.75" diameter.

CODE	Size	Unit	4+	1+
PRT225SLV	9"/225mm x 1.75"	1	3.50	3.80

## Paint Scraper



- Popular paint scraper we purchase in bulk, hence the lower price.
- Blade width 80mm.

CODE	Size	Unit	4+	1+
SCR300PNT	3"/80mm	1	2.25	2.50

## Mini Roller Kit



- Complete Mini Roller kit includes rollers (1 x emulsion, 1 x gloss), handle and tray.
- Roller width 4"/100mm.

CODE	Size	Unit	4+	1+
PRT100KIT	4"/100mm	1	3.00	3.30

## Steel Extension Pole



- Two part telescopic pole.
- Extends from 2ft 6in to 4ft 6in (760mm to 1370mm).

CODE	Description	Unit	4+	1+
STP426TEL	Steel 2 Section	1	6.20	6.70

## Taping Knife 10"



- Trade quality drywall taping knife for easy application of tape and fillers.
- Soft grip handle with a flexible blued steel blade.
- Blade width 250mm/10".

CODE	Description	Unit	4+	1+
TAP250KNF	Taping Knife 10"/250mm	1	7.30	8.15

**Standard Decorators Tools**



- Bi-material handle.
- Stainless steel.

**Putty Knife**

CODE	Size	Unit	4+	1+
PTK112STD	1½"	1	4.20	4.45

**Scraper - Stiff Blade**

CODE	Size	Unit	4+	1+
SCR200STD	2"	1	2.40	2.65
SCR300STD	3"	1	4.45	5.05

**Filling Knife - Flexible Blade**

CODE	Size	Unit	4+	1+
FLK200STD	2"	1	3.95	4.20
FLK300STD	3"	1	4.20	4.45

**Professional Decorators Tools  
Rosewood Handles**



- Professional with a solid tang.
- Rosewood handle.
- Stainless steel.

**Scraper - Stiff Blade**

CODE	Size	Unit	4+	1+
SCR100PRO	1"	1	4.20	4.45
SCR200PRO	2"	1	4.90	5.35
SCR300PRO	3"	1	5.05	5.65

**Filling Knife - Flexible Blade**

CODE	Size	Unit	4+	1+
FLK100PRO	1"	1	4.45	4.80
FLK200PRO	2"	1	5.35	5.90
FLK300PRO	3"	1	8.15	8.95

**Combination Shavehook**



- Sharpened ground steel blade.
- Combination shape for flat, irregular and curved surfaces.
- Hardwood handle.

CODE	Description	Unit	4+	1+
SVH123CMB	Comb. Shavehook	1	3.30	4.45

**Plastic Kettle and Lids**



- White plastic with metal handle.
- Supplied in two sizes, lids also available.

CODE	Description	Unit	4+	1+
PKT100CAN	Plastic Kettle 1L	1	1.45	1.50
PKT100LID	Plastic Kettle Lid 1L	1	0.75	0.80
PKT250CAN	Plastic Kettle 2L	1	1.95	2.20
PKT250LID	Plastic Kettle Lid 2L	1	0.80	0.90

**Small Mixing Paddle**



- Paint stirrer that fits most electric drills for fast efficient mixing of paint.
- Head diameter 60mm with a hex shank.

CODE	Size	Unit	4+	1+
MPD060HEX	Small Paddle 60mm Dia.	1	3.50	3.80

**Paint Scuttle 15L**



- 15 litre plastic paint scuttle.
- Strong metal handle.

CODE	Description	Unit	4+	1+
PSC150PLA	Paint Scuttle	1	5.55	6.20

**Metal Paint Kettle**



- Heavy duty seamless metal can with a wire handle.

CODE	Description	Unit	4+	1+
MKT150CAN	Metal Paint Kettle 1.5L	1	8.95	9.85

**Stockinette Roll**



- Highly absorbent knitted cotton for numerous cleaning and polishing applications.
- Weight: 400g roll.

CODE	Description	Unit	4+	1+
SKN400ROL	400g Roll	1	6.70	7.30

## Foam Decorating Sponge



- Foam sponge ideal for most decorating and cleaning jobs.
- Size: 185 x 105 x 50mm.

CODE	Size	Unit	4+	1+
SPG185DEC	185 x 105 x 50mm	1	1.30	1.45

## Paste Table



- Folding paste table with wipe clean laminated top and metal 'W' trestle leg construction.
- Extremely strong, sturdy design that combines lightness with rigidity.

CODE	Description	Unit	4+	1+
TBL200PAS	2000 x 600mm	1	57.75	59.95

## Decorating Scissors



- Plastic handled general purpose scissors.

CODE	Size	Unit	4+	1+
SCS100DEC	Scissors 10"/250mm	1	3.15	3.50

## Seam Roller



- For the final finishing touch when wallpapering.
- Soft grip handle for added comfort.

CODE	Description	Unit	4+	1+
SRL380SGP	Seam Roller	1	2.80	3.15

## Professional Lining Paper 800 or 1200 Grade



- Smooths out walls in preparation for painting or overhanging with decorative wall coverings.
- Provides an excellent base surface, very easy to use and contains no PVC or fibreglass.
- Pulp is derived from well managed FSC or PEFC sources.
- 10m length x 560mm roll.

CODE	Description	Unit	4+	1+
LNP800PRO	800 Grade	1	3.30	3.50
LNP120PRO	1200 Grade	1	4.65	5.35

## Plumb Bob and Line



- Decorator's style plumb bob to ensure accurate hanging of wallpaper.
- Plated steel body - 15mm diameter x 55mm long.

CODE	Description	Unit	4+	1+
PLB050SML	Plumb Bob and Line	1	2.80	3.10

## Rubber Sanding Block



- Abrasive papers can be cut to size to fit the sanding block.
- Holds the abrasive sheet firmly in place.
- Size 70 x 125mm.

CODE	Description	Unit	10+	4+	1+
RSB125BLK	70 x 125mm	1	2.90	3.10	3.50

## Paint Brush Cleaner 500ml or 2 Litre



- A solvent based cleaner containing emulsifiers enabling wet household paint and varnish to be efficiently cleaned from brushes, roller and pads.

CODE	Description	Unit	6+	1+
PBC500CLN	500ml	1	4.50	4.95
PBC002CLN	2 Litre	1	12.95	14.50

## Paint Brush Restorer



- A solvent based cleaner/restorer. Brushes recently hardened with dry paints can be revived by soaking overnight.
- Suitable for emulsion, oil based and cellulose paints/varnishes.

CODE	Description	Unit	6+	1+
BRR500RES	Restorer	1	7.50	8.25

### Classic Colour Acrylic Scumble

1, 2 or 4 Litre



- A clear acrylic glaze that works in one hour.
- When coloured with satin or matt emulsion/latex, this beautiful acrylic glaze can be used to produce semi-transparent coloured paint effects.

CODE	Size	Unit	1+
SCB001CLS	1 litre	1	19.95
SCB002CLS	2 litre	1	35.95
SCB004CLS	4 litre	1	59.95

### Original Acrylic Scumble

500ml, 1 or 4 Litre



- A stunning clear acrylic glaze, offering a one-hour working time.
- Dries to a beautiful and water-resistant finish.
- Can be coloured with the Acrylic Colourant for stunning decorative paint effects.

CODE	Size	Unit	1+
SCB500ORG	500ml	1	11.95
SCB001ORG	1 litre	1	19.95
SCB004ORG	4 litre	1	59.95

### Acrylic Colourant

50g



- A super high-quality acrylic pigment that's been specially formulated to give superior colour saturation.
- Can be used with all water-based products including scumble glaze, stain, emulsion, varnish and interior paint, glue, filler, masonry paint, tile grout and cement.
- Available in 10 popular mixable colours

CODE	Colour	Unit	1+
SCB050RED	Red	1	2.65
SCB050BLU	Blue	1	2.65
SCB050YEL	Yellow	1	2.65
SCB050GRN	Green	1	2.65
SCB050WHT	White	1	2.65
SCB050BLK	Black	1	2.65
SCB050MAH	Mahogany	1	2.65
SCB050MOK	Medium Oak	1	2.65
SCB050DOK	Dark Oak	1	2.65
SCB050WAL	Walnut	1	2.65

### All Purpose Filler Powder



- Heavy-duty tough filler - will accept nails or screws when dry.
- Non Shrink.
- Overpaintable with most solvent based and emulsion paints.
- Overstainable.

CODE	Size	Unit	10+	4+	2+	1+
EVE015FLL	1.5kg	1	5.25	5.75		6.25
EVE050FLL	5kg	1		15.25	16.25	17.95

### Sugar Soap Liquid



- Sugar Soap effectively removes grease, grime and nicotine from painted surfaces to ensure improved adhesion.
- Ideal as a general household cleaner.
- 500ml concentrated liquid.

CODE	Size	Unit	12+	4+	1+
SUG500LQD	500ml	1	2.95	3.20	3.50

### One Hour Caulk



- Fast drying flexible decorators filler and sealant that remains permanently flexible.
- Can be overpainted with most paint types or covered over with wallpaper, no sanding down required.

CODE	Description	Unit	12+	6+	1+
EVE125CAU	125 One hour Caulk	1	2.50	2.60	2.95

### Spid Type Brush



- Brass plated crimped steel wire brush held in a steel spine with a polypropylene handle.
- The narrow style, thin spine and curved end allows easy access into slots and tight locations.
- Overall length 250mm.

CODE	Description	Unit	10+	4+	1+
SDT250BRU	10" Length	1	2.50	2.75	2.95

### 4 Row Handbrush



- Steel wire filling with wooden handle.
- 11" overall length.
- Heavy duty with long length increased fill wire brush.

CODE	Description	Unit	10+	4+	1+
HBR4ROWST	4 Row Handbrush	1	1.95	2.25	2.75

### Mini Wire Brush Set

3 Piece



- An industrial toothbrush set!
- Nylon brush for fabrics and gentle cleaning.
- Brass brush for more aggressive cleaning.
- Steel brush for removing rust and heavy cleaning.

CODE	Description	Unit	4+	1+
BRU300SET	Mini Brushes Set	3 Piece	2.75	3.25

## Stromberg Hand Pipe Bender 15 and 22mm



- Compact tube bender with precision high pressure aluminium die cast formers and guides to produce sets, offsets, multiple bends in copper.
- Strong tubular steel handles with a cast iron head that can be held in a vice for use as a bench bender.
- Supplied complete with 15 mm and 22 mm formers and guides.
- Leading arm has pre-set rollers for speed of operation.
- Covered with Stromberg's 10 year guarantee.

CODE	Description	Unit	10+	4+	1+
SBG152PBD	15 and 22mm	1	39.95	45.00	49.95

## Stromberg Stillson Pipe Wrench 14"



- The steel adjustment nut has been both hardened and tempered for maximum strength.
- Accurately machined screw threads and nut with sprung jaw - stays open until pressure is applied.
- Length: 350mm/14" and jaw capacity: 51mm/2".
- Covered with Stromberg's 10 year guarantee.

CODE	Description	Unit	10+	4+	1+
SBG140STL	Wrench 14"	1	9.95	11.95	12.95

## Boston Hinged Pipe Vice



- Boston Hinged Pipe Vices are guaranteed for 10 years against breakage with exceptional strength..
- Single V-jaw in frame moves between two V-jaws in base to hold even the smallest pipe sizes securely.
- Self locking frame is reversible for right or left-hand operation.
- Can be fitted to bench and or stand.
- Capacity: 3 to 50mm (1/8" to 2").

CODE	Description	Unit	10+	4+	1+
BST092HPV	Hinged Pipe Vice 2"	1	59.95	65.00	79.95

## Eclipse Telescopic Tube Cutters



- For cutting copper, brass, aluminium and light gauge steel tube.
- Fast adjusting telescopic action.
- Includes an integral deburrer and a spare cutting wheel.

CODE	Description	Unit	4+	1+
ECLECTC32	Tube Cutters 3-22mm	1	13.45	14.05

## Eclipse Copper Pipe Slicer



- Single handed operation – ideal for use in confined areas.
- Two sizes available, for use with 15mm and 22mm copper tube.

CODE	Size	Unit	4+	1+
ECLEPCPS15	15mm	1	8.95	9.40
ECLEPCPS22	22mm	1	10.70	11.20

## Eclipse Plastic Pipe Cutter



- For cutting PVC, polythene, MDP and polyethylene pipe, HEP 20, plastic overflow pipe and rubber hoses etc.
- High quality stainless steel blades ensure clean cuts without distortion to the plastic tubing.
- Ratchet system ensures a fast and efficient cut.

CODE	Size	Unit	4+	1+
ECLEPPC32	32mm	1	10.95	11.55
ECLEPPC42	42mm	1	12.10	12.70

## Rothenberger Ropower 50R Electric Pipe Threader



- Quick and reliable threading, trimming, deburring, and grooving.
- Supplied with a portable transport frame.
- Die head Type R - automatic with integrated oil feed.
- Complete pre- and post-processing of pipe.
- Motor rating:1150W, 110V.

CODE	Description	Unit	1+
RTB050RPW	Ropower 50R	1	2894.75

## Rothenberger Thread Cutting Oil



- Safe for skin contact.
- For perfect, clean threads.
- Excellent cooling and lubricating properties.
- Durability of the threading is increased considerably.

CODE	Description	Unit	5+	2+	1+
RTB006TCS	Spray 600ml	1	18.25	18.75	19.95
RTB5000IL	Oil 5 Litre	1	33.50	34.75	36.75



### Rothenberger Tripod Stand with 6" Vice



- Stable, non-slip folding frame.
- Supplied with integral 6" chain vice.
- Suitable for bending pipes  $\varnothing \frac{3}{8}$  -  $\frac{1}{2}$  -  $\frac{7}{8}$ .

CODE	Description	Unit	2+	1+
RTB600TSV	Tripod Stand with 6" Vice	1	701.50	751.50

### Rothenberger RP30 Pressure Testing Pump



- Compact pump for testing pipework including underfloor heating.
- Testing hose with steel mesh prevents reading mistakes.
- Shock and corrosion resistant ABS plastic container with reinforced floor.
- Maximum pressure 30 bar.
- Tank capacity 4.5 litres.
- Connection R  $\frac{1}{2}$ " BSPT.

CODE	Description	Unit	1+
RTB030PTP	RP30	1	232.50

### Rothenberger Pressure Test Nipples Pack of 3



- Re-useable test nipples for pressure testing.
- Pressure test nipples  $\frac{1}{8}$ " BSP.
- Made from brass.

CODE	Description	Unit	2+	1+
RTB300PTN	Test Nipples	Pack of 3	5.50	5.95

### Rothenberger Quick Release Chain Vice 4"



- V-shaped pipe supports with teeth and bridge prevent undesired bending during clamping.
- Exchangeable jaws.
- Lever action to tighten or release the chain.

CODE	Description	Unit	2+	1+
RTB400CHV	Chain Vice 4"	1	353.25	378.50

### Rothenberger RP50 Pressure Testing Pump



- Maximum Pressure 60 bar (840 psi).
- Tank Capacity 12 Litres.
- Connection R1/2" BSPT.

CODE	Description	Unit	1+
RTB050PTP	RP50	1	439.75

### Rothenberger Rubber Hose



- Durable construction for use with manometers.
- 2 metre length x  $\frac{1}{4}$ " bore.

CODE	Description	Unit	2+	1+
RTB200RHS	Rubber Hose 2 Metres	1	3.90	4.10

### Rothenberger Hole Saw Kit



- Selected hole saws to suit plumbers – 19, 22, 29, 38, 44 and 57mm.
- Bi-metal HSS steel cutters.
- Includes two arbors to suit all sizes.

CODE	Description	Unit	5+	2+	1+
RTB600HSW	Hole Saw Kit	1	55.25	57.75	61.75

### Rothenberger U-Gauge Manometer



- A durable plastic casing with a clearly marked scale in millibar. 12"/30mb.
- New design incorporates magnetic strips for securing to boiler cabinets while in use.
- Adjustable velcro strip allows manometer to be hung vertically during use.
- Made in the UK.

CODE	Description	Unit	2+	1+
RTB030UGM	Manometer 12"/30mb	1	14.25	15.25

### Rothenberger Dry Pressure Test Kit



- Rapid joint testing for checking leaks prior to filling the system with water.
- Gauge fitted with a rubber boot for protection quick and reliable locating of leaks.
- Test range 0-4 bar.

CODE	Description	Unit	2+	1+
RTB040DPT	Dry Pressure Test Kit	1	39.50	41.75

## Rothenberger Water Pressure Gauge



- Range from 0-10 bar , 0-50psi.
- Easy read analogue display.
- Protective rubber boot for protection during transport.
- 3/4" BSP tap connector.

CODE	Description	Unit	2+	1+
RTB010WPG	Water Pressure Gauge	1	17.25	18.25

## Rothenberger Rotest Leak Detection Fluid



- Leak detection on gas lines.
- Highly sensitive foaming spray for a quick and reliable locating of leaks.
- Atomiser spray 250ml.

CODE	Description	Unit	5+	2+	1+
RTB250LDF	Detection Fluid 250ml	1	2.10	2.20	2.30

## Rothenberger Adjustable Wide Jaw Wrench



- Extra wide opening for use in confined spaces.
- Hot forged chrome vanadium.
- Non-slip ergonomic soft-grip handles.
- Supplied with removable soft-grip jaw protectors for use on chrome or polished fitting.
- 10" x 50mm opening and 6" x 34mm opening.

CODE	Size	Unit	5+	2+	1+
RTB600ADS	6" x 34mm	1	23.25	23.95	25.50
RTB100ADS	10" x 50mm	1	32.25	33.25	35.25

## Rothenberger Water Flow Measure



- Durable ABS container.
- 2.5 - 20 litre.
- Hard wearing, easy to read scales.

CODE	Description	Unit	2+	1+
RTB054WFM	Water Flow Measure	1	19.95	21.25

## Rothenberger Freeze-Pak Pipe Freezing Kit



- Consisting of:  
500gm Quick Freeze Spray, Two Pipe Freezing Jackets and Four cable ties.

CODE	Description	Unit	5+	2+	1+
RTB500FZP	Pipe Freezing Kit	1	29.50	30.50	32.25

## Rothenberger Telescopic Basin Wrench



- Chrome-plated, with pivoted reversible jaw for right and left-handed rotation.
- Size 32mm capacity.
- Length from 275mm to 455mm.

CODE	Description	Unit	5+	2+	1+
RTB032TBW	Tel. Basin Wrench	1	27.95	29.25	31.25

## Rothenberger Smoke Pellets Pack of 6



- Tube of 6 x 13g.
- Mandatory for testing flues, chimneys, pipework, boilers and drains.

CODE	Description	Unit	2+	1+
RTB613SMP	Smoke Pellets Pack of 6		5.50	5.95

## Rothenberger Super Fire 2 Torch Head



- Concentrated, high heat, anti flare, adjustable flame.
- Durable die cast gear housing and a fibreglass-reinforced plastic body.
- Turbine flame pattern.
- Instant Piezo ignition.
- Can be used at any angle.
- Use with any MAP/PRO or Propane disposable cylinders.

CODE	Description	Unit	5+	2+	1+
RTB200SPF	Super Fire 2 Torch Only	1	83.95	86.50	90.50

## Rothenberger Monoblock Tap Spanner Set 3 Piece



- Set of three Monoblock Tap Spanners and Tommy Bar.
- To suit most monoblock security bolts.
- Brushed chrome finish.

CODE	Description	Unit	5+	2+	1+
RTB300MSS	Monoblock Tap Spanners	1	3.50	3.60	3.90

### Rothenberger Hydraulic Pipe Bender



- Precise bending with the angle scale on the support brackets.
- Reduces welded joints.
- No pre-warming of pipe is required.
- Covers sizes 3/8" to 2".
- Compact hydraulic bender with 15 tonne pressure ram and automatic piston return.

CODE	Description	Unit	5+	2+	1+
RTB382HPB	Robull Hydraulic Pipe Bender	1	1843.25		

### Rothenberger Tap Backnut Spanner



- Anti rust chrome finish.
- Fits most 1/2" and 3/4" backnuts.

CODE	Description	Unit	5+	2+	1+
RTB123TBS	Tap Backnut Spanner	1	2.95	3.20	3.40

### Rothenberger Multibender



- Industrial standard portable tube / pipe bender.
- For use on copper and light grade stainless steel tube.
- Easy to use, lightweight, portable and robust.
- Complete with 15 and 22mm aluminium formers and guides - in carrying pouch.
- Can be clamped into a vice.

CODE	Description	Unit	5+	2+	1+
RTB152MBS	Multibender	1	85.25	87.95	93.25

### Rothenberger Supercut Ratchet Threader Set



- Slim, compact design with excellent overall size, ratchet angle of 22.5°.
- Simple insertion and removal of die heads.
- Perfect centering through the long pipe guide is ensured.
- Optimised cutting geometry allows a gentle first cut and excellent chip discharge.
- Supplied with three die heads - BSPT 1/2", 3/4" and 1".

CODE	Description	Unit	2+	1+
RTB121RTS	Ratchet Threader Set	1	278.25	298.25

### Rothenberger Immersion Heater Spanner



- Zinc plated steel.
- Cranked handle.
- Size 86mm.

CODE	Size	Unit	5+	2+	1+
RTB086CRS	Heater Spanner	1	2.60	2.80	2.95

### Rothenberger Auto Tube Cutter



- For copper, brass, aluminium, thin-walled steel pipes, as well as plastic coated pipes 6-67mm diameter.
- Retractable internal deburrer and spare cutter wheel in handle Monoblock design.
- Quick adjustment with the ratchet telescopic guide with automatic spring-driven release.
- Self-clamping prevents release due to quick adjustment during the cutting process.

CODE	Description	Unit	5+	2+	1+
RTB667ATC	TCutter (6-67mm)	1	117.75	122.75	131.50

### Rothenberger Enclosed BSPT Die Head



- With enlarged shaving discharge chambers.
- For faster threading, reinforced locking plate and precise die seating.
- Fits in Rothenberger Supertronic 1000, Supertronic 1250, Supertronic 2000 and super cut threaders.

CODE	Description	Unit	2+	1+
RTB120DHD	Die Head 1/2"	1	64.95	69.75
RTB340DHD	Die Head 3/4"	1	65.75	70.50
RTB100DHD	Die Head 1"	1	75.75	81.25

### Ratchet Pipe Threading Set 6 Piece



- Ratchet Pipe Threading System with six sizes of BSPT dies.
- Supplied with two extension bars.
- Die sizes: 1/4", 3/8", 1/2", 3/4", 1", 1 1/4"

CODE	Description	Unit	1+
RTB600SET	6 Piece Set	1	69.95

### Rothenberger Stillson Pipe Wrench



- Optimised double-spring construction guarantees quick and firm self-clamping, ensuring secure hold even on smooth pipes.
- Unbreakable housing and shaft.
- Hardened adjustment nut presses onto the handle during use and prevents undesired readjustment.
- 14" or 18"

CODE	Description	Unit	5+	2+	1+
RTB140STL	Pipe Wrench 14"	1	54.50	56.95	60.95
RTB180STL	Pipe Wrench 18"	1	74.25	77.50	82.95

## Rothenberger Pipeslice Tube Cutter



- Single action, one handed cutter ideal for confined spaces.
- Quick cutting of copper pipe with less turns.
- No deformation of the pipe: self-clamping and self-alignment.
- Less space required, ideal for hard-to-reach places.

CODE	Size	Unit	5+	2+	1+
RTB015PSC	15mm	1	20.95	21.95	23.50
RTB022PSC	22mm	1	22.50	23.50	25.25
RTB028PSC	28mm	1	35.75	37.25	39.95

## Rothenberger SPK Water Pump Plier

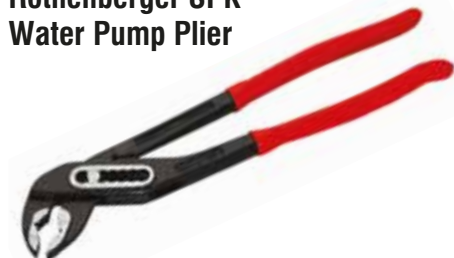

- Complies with DIN 5231 D, with heavy-duty box joint, chrome vanadium steel, drop forged, tempered, polished head and joint.
- Optimum grip for reliable hold of pipes, flat objects squared and hexagonal screws.
- Long service life through induction hardened teeth.
- Variable use: 7 size settings.
- Non-slip even on smooth surfaces.
- Safe use with the crush and pinch protection.

CODE	Description	Unit	5+	2+	1+
RTB100WPP	Water Pump Plier 10"	1	25.25	26.25	28.25
RTB120WPP	Water Pump Plier 12"	1	35.50	36.95	39.75

## Rothenberger Rocut Plastic Pipe Shear



- For precise cutting of plastic pipe up to 26mm.
- Shear arms lockable in transport position.
- Secure grip with the rubberised handles.
- Precise right-angled cuts.
- Precise pressure transfer and guided cutter feed.
- Pin-point precision without deformation.
- Automatic, controlled opening of the blade at the push of a button.

CODE	Description	Unit	5+	2+	1+
RTB260PPS	Rocut 26TC	1	26.50	27.50	29.50

## Rothenberger Pipe Cutter Steel



- Wide rollers for secure guiding of cutter wheel on pipe.
- Easy pressure control for optimum force transmission onto the pipe up to 1 1/4 diameter.
- Long service life with the hardened cutter wheel made of high alloy steel.
- Burr-free external cutting allows for immediate thread cutting.

CODE	Description	Unit	5+	2+	1+
RTB114SPC	Pipe Cutter Steel	1	145.95	151.95	162.95

## Rothenberger Plasticut Pipe Cutter Pro



- Unique rotary plastic pipe cutter capable of cutting both 35mm and 42mm pipe.
- Hinged body design for simple and safe to use.
- Cuts cleanly and squarely without deforming the pipe.
- Blade is easy to change and a spare blade is supplied with the cutter.

CODE	Description	Unit	4+	1+
RTB354PPC	35/42mm	1	27.75	29.25

## Rothenberger Rofrost Turbo Electric Freezer



- Pipe freezing system for copper, steel and plastic composite pipes.
- Thermometer on the freezer clamp indicates when the pipe is completely frozen.
- Reduction inserts in various sizes for all common pipe diameters - 12, 15, 22, 28, 35 and 42mm.
- With the flexible hose and the simple clamping system even working overhead and in confined spaces is not a problem.
- The use of heat conductive paste guarantees an optimum icing. It prevents air pockets between the freezing clamps and pipe. The pipe does not need to be sprayed with water.

CODE	Description	Unit	1+
RTB042TEF	12-42mm (230V)	1	1574.50

## Rothenberger Gas Cartridge Adaptor



- To fit Primus 2000/Calor 340.
- Adaptor for standard torches to disposable gas cartridge.

CODE	Description	Unit	5+	2+	1+
RTB234ADP	Gas Cartridge Adaptor	1	17.75	18.50	19.75

## Rothenberger Disposable Propane Gas Cartridge



- Gas cartridges for flame temperatures up to 1,900°C.
- With EU coupling 7/16".

CODE	Description	Unit	5+	2+	1+
RTB400PRP	Propane 400g	1	9.95	10.25	10.75

## Rothenberger Disposable MAP/Pro Cartridge



- Special gas mix for high-performance soldering and brazing work.
- Extremely high flame temperature, 2400c.
- Guaranteed constant top torch performance.
- Increased user safety through the sandwich valves and aluminium mono-block cylinder.

CODE	Description	Unit	5+	2+	1+
RTB399MAP	MAP/P Gas 399g	1	15.50	15.95	16.75

### Hanson Steel Wool Medium



- Medium grade for cleaning joints.
- British made.
- Pack size 450g.



CODE	Grade	Size	Unit	5+	2+	1+
HAN450MSW	Medium	450g	1	5.25	5.65	5.90

### Rothenberger Mini Strips

Pack of 10



- The 'flexible' file used to rough up, deburr, clean and remove paint and oxides from pipes and pipe fittings.
- Waterproof and durable.
- Medium Grade.

CODE	Description	Unit	2+	1+
RTB010ABR	Mini Strips	Pack of 10	8.25	8.75

### Rothenberger Soldering Mat



- Gold Silica 2 ply reversible soldering mat 300 x 140mm.
- With new Ecomab high temperature paper infill - protects up to 1000°C.
- Wire reinforced, flame proof thread - asbestos free.
- Made in the UK.

CODE	Description	Unit	2+	1+
RTB252MAT	Soldering Mat	1	11.50	12.25

### Monument Omat (R)



- Variable cut out heat pad for soldering 15/22mm copper pipe.
- Professional quality woven glass heat pad.
- Patented product made in UK.

CODE	Size	Unit	4+	1+
MON2355PD	15/22mm / 12" x 12"	1	34.50	36.95

### Monument Heat Resistant Mat



- This heat pad resists temperatures up to 600°C and does not present any of the hazards associated with asbestos material.
- Made from HDW graphite material (professional quality).
- Size 250 x 250mm/10" x 10".

CODE	Size	Unit	4+	1+
HRT250PRF	10" x 10" (250 x 250mm)	1	6.50	6.95

### Monument Soldering and Brazing Pad



- Professional quality woven glass heat pad.
- Resists temperatures up to 600 °C.
- Eyelet allows mat to be suspended during use.

CODE	Size	Unit	4+	1+
MON2350PD	12" x 12"	1	20.25	21.75

### Monument Adjustable Copper Pipe Cutter



Pipe Cutter No.0 4-22mm



Pipe Cutter No.1 4-28mm



Pipe Cutter No.2 12-43mm

MON273WHL

- Adjustable copper pipe cutter x 3 capacities.
- Ratchet action.
- Pressure diecast body.
- All parts liable to wear are heat treated.
- Replacement wheel available.

CODE	Capacity	Unit	4+	1+
MON264PCU	4 - 22mm	1	19.75	21.25
MON265PCU	4 - 28mm	1	26.50	28.25
MON266PCU	12 - 43mm	1	29.75	31.75

#### Spare Wheel

CODE	Description	Unit	4+	1+
MON273WHL	Spare Wheel	1	2.50	2.70

### Monument Automatic Copper Pipe Cutter



MON269WHL

- Pressure diecast body
- Replacement wheel available

CODE	Size	Unit	4+	1+
MON1715AC	15mm	1	17.75	18.95
MON1722AC	22mm	1	19.50	20.75
MON1728AC	28mm	1	32.95	35.50

#### Spare Wheel for 15, 22 and 28mm

CODE	Size	Unit	4+	1+
MON269WHL	15, 22 and 28mm	1	3.10	3.30

## Monument Internal Bending Spring



- Made from square section steel.
- Polished finish.

CODE	Size	Unit	4+	1+
MON830BSG	15mm	1	9.75	10.50
MON832BSG	22mm	1	10.25	10.95

## Monument Pipe Bender Extension Handle

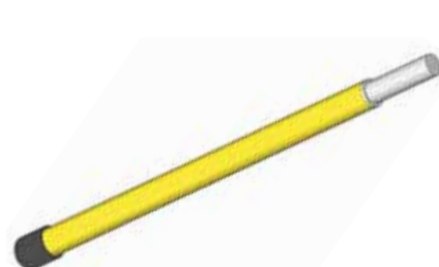

- For use with pipe bending machine.
- Fits in to and extends the bending arm.

CODE	Description	Unit	4+	1+
MON2626EH	Extension Handle	1	19.95	21.50

## Monument Disposable De-Burr Tool



- Ideal for de-burring inside copper pipe.
- Swivelling blade rotates freely to enable all sorts of de-burring operations.
- Works on steel, copper, brass, plastics, wood and castings.

CODE	Size	Unit	4+	1+
MON3020DB	Debur Tool	1	5.25	5.75

## Monument Plastic Pipe Cutter



- Plastic pipe cutter cuts most plastic pipes for plumbing and electrics.
- Unique renewable blade design.
- Scale on handle for cutting short lengths of tube accurately.
- Two sizes available – 28mm and 42mm.

CODE	Size	Unit	4+	1+
MON2644PC	28mm	1	28.50	30.50
MON2645PC	42mm	1	33.75	36.25

## Monument Pipe Bender



- Bends copper and stainless plumbing pipe.
- Formers marked with bending angles.
- Supplied with 15 and 22mm guides and spare guides available.

CODE	Description	Unit	4+	1+
MON2600PB	Pipe Bender	1	97.95	104.75

### Spare Guides

CODE	Size	Unit	4+	1+
MON2601GU	15mm	1	11.95	12.75
MON2603GU	22mm	1	14.75	15.75

## Monument Internal/External Deburrer



- Deburrs internally and externally up to 38 mm.
- Suitable for copper tube and some plastic tubes.

CODE	Size	Unit	4+	1+
MON365DBR	Deburrer	1	8.95	9.75

## Monument Fixed Size Copper Pipe Cutter



- Pressure diecast body.
- Replacement wheel available.

CODE	Size	Unit	4+	1+
MON1806PC	6mm	1	20.25	21.75
MON1808PC	8mm	1	20.25	21.75
MON1810PC	10mm	1	17.50	18.50

### Spare Wheels

These cutters above take the same spare wheel as the Automatic Copper Pipe Cutter on the previous page.

## Monument Mini Pipe Bender



- For use with 6/8/10mm microbore copper tube.
- Make up to 180 degree bends.

CODE	Description	Unit	4+	1+
MON2611PB	Mini Pipe Bender	1	28.75	30.75

## Monument Copperkey Int./Ext. Brush



- Ratcheting tool for quick, thorough pipe and fitting preparation.
- Patented ratchet handle makes jobs possible in all tight spaces.
- Patented tungsten carbide abrasive.

CODE	Size	Unit	4+	1+
MON2915CK	15mm	1	19.50	20.75
MON2922CK	22mm	1	25.25	26.95

### Monument Immersion HTR Box Spanner with T-Bar



- Made with octagon at base of steel cylinder.
- Without slot to ensure removal of immersion heater flex, to reduce the possibility of electric shock.
- Supplied with a separate tommy bar.

CODE	Size	Unit	4+	1+
MON358BXS	A/F size 3 <sup>3</sup> / <sub>8</sub> "/86mm	1	15.50	16.50

### Monument Olive Puller



- Patented tool for removing 15mm, 22mm and 3/4" olives
- Engages with 14tpi thread of the compression fitting.

CODE	Size	Unit	4+	1+
MON2036PL	Olive Puller 15/22mm	1	41.75	44.75

### Monument Valve/Radiator Spanner



- Zinc plated steel spanner with comfortable, slightly offset, handle.
- For 3/8" and 10mm square section radiator vent plugs and bleed screws.
- Hexagon: 1/2"/12.7 mm.

CODE	Description	Unit	4+	1+
MON2053RV	3/8" and 10mm	1	5.50	5.95

### Monument Cleaning Pads Pack of 6

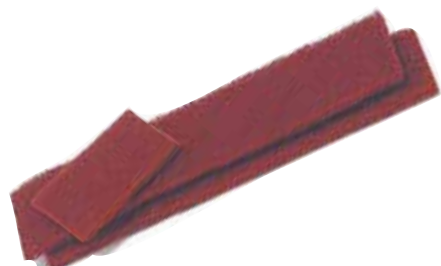

- Medium grade pads for cleaning, polishing, rust removal, scrubbing and blending.
- Washable, will not rust and does not break up during use.

CODE	Description	Unit	4+	1+
MON3025CP	Cleaning Pads	Pack of 6	9.75	10.50

### Monument Olive Removing Tool



- Designed to remove an olive from copper pipe without damage to the pipe and without producing swarf.
- Available in 2 sizes.

CODE	Size	Unit	4+	1+
MON2030RT	15mm	1	47.95	51.25
MON2031RT	22mm	1	48.75	52.25

### Monument Valve Spanner and Air Release Key



- Zinc plated steel spanner with comfortable, slightly offset, handle.

CODE	Description	Unit	4+	1+
MON2054VS	Air Release Key	1	5.50	5.95

### Monument Abrasive Clean Up Strips Pack of 10



- 180 grit silicone carbide strips of abrasive waterproof open mesh material for tough cleaning jobs.
- For roughing up copper, metal and plastic pipe and inside fittings when cut into strips.

CODE	Description	Unit	4+	1+
MON3024AB	Clean-Up Strips	Pack of 10	9.25	9.95

### Monument Brass Radiator Bleed Key Pack of 2



- For releasing air in radiators.
- Clock key type for key ring.

CODE	Description	Unit	4+	1+
MON2057RK	Radiator Bleed Key	Pack of 2	3.10	3.30

SEE HAND TOOLS

### Pro Water Pump Pliers



## Monument Fitting Spanner



- Pressed steel 15 and 22mm compression fitting spanner.
- A/F 24 and 32mm.

CODE	Size	Unit	4+	1+
MON2032SP	A/F 24 and 32mm	1	3.60	3.90

## Monument Heavy Duty Compression Fitting Spanner



- Heavy duty 15 and 22mm compression fitting spanner.
- Drop forged steel.
- A/F 24 and 32mm.

CODE	Size	Unit	4+	1+
MON2069SP	A/F 24 and 32mm	1	10.25	10.95

## Monument 2-Jaw Professional Adjustable Basin Wrench



- Used for loosening and tightening nuts in awkward positions on basin and bath taps.
- The tommy bar is removable and it has a round steel handle with hexagon for attachment to a socket and extension for added length.

CODE	Size	Unit	4+	1+
MON345BWR	15 and 22mm/1/2" and 3/4"	1	39.95	42.75

## Monument Tap Backnut Box Spanner



- Double ended box spanner for quick assembly of tap back nuts on basins.
- Length 205mm.

CODE	Size	Unit	4+	1+
MON323BXS	27 x 32mm	1	8.75	9.25

## Monument 10" Multiangled Wrench



- Multiangled head position.
- Cast aluminium.
- 250mm.

CODE	Description	Unit	4+	1+
MON2716MW	Wrench -10"	1	49.95	53.50

## Monument DIY Telescopic Plumbing Wrench



- Telescopic handle with spring jaws for basin and bath tap back nuts.

CODE	Description	Unit	4+	1+
MON781BWR	Telescopic Wrench	1	20.25	21.75

## Monument Plated Steel Box Spanner Set 4 Piece



- Double ended plated steel box spanners for quick assembly of tap back nuts on basins.
- Includes tommy bar. A/F 8, 9, 10, 11, 12 and 13mm.

CODE	Size	Unit	4+	1+
MON3240SP	Box Spanners Set	4 Piece	9.95	10.75

## Monument Shetack™ Basin Wrench



- The original Shetack™ basin wrench for fitting back nuts and union nuts.
- Strong malleable material.
- Length 260mm.

CODE	Size	Unit	4+	1+
MON327BWR	1/2" and 3/4"/15 and 22mm	1	10.50	11.25

## Monument Dry Test Kit



- For dry testing of pressure systems prior to commissioning.
- Complete with Schrader valve and 15mm Pushfit® fitting.
- Maximum 4 bar.

CODE	Description	Unit	1+
MON1512TK	Dry Test Kit 15mm	1	49.75



### Monument Vent Sizing Gauge



- Use to measure vent slots to calculate the area of ventilation.
- Stepped in increments of 1mm from 5-10mm.
- Stainless steel.

CODE	Description	Unit	4+	1+
MON2580VG	Vent Sizing Gauge	1	4.90	5.25

### Monument Water Flow Gauge



- For easy and quick setting of operating flow rates to manufacturers specification.
- Dual scale 2 to 25 litres, 1 to 5 gallons.
- Sturdy durable plastic design. Long life stainless steel mesh strainer avoids turbulence.

CODE	Description	Unit	1+
MON1515WG	Water Flow Gauge	1	36.25

### Monument 30MB Gas Test Gauge



- To test pipework pre and post gas supply being introduced.
- Made in UK from tough plastics.
- For checking and setting correct gas pressures on appliances.
- Marked in millibars the scale adjusts, to zero the water level.

CODE	Description	Unit	1+
MON257GTG	Gas Test Gauge	1	24.75

### Monument Medium Level Best 2



- All in one Handy Precision Unit.
- With Embossed ruler graduations and numbers.
- Open slot for easy markings.

CODE	Description	Unit	4+	1+
MON388LEV	Level 12" x 12"	1	25.50	27.95

### Monument 50 Bar Test Pump



- For leak testing on water installations.
- Plastic tank: light and shock resistant (4.2kg).
- Easier reading with 1bar graduations.

CODE	Description	Unit	1+
MON262035	Test Pump 5 Litre	1	289.50

### Monument Nylon Drain Plug



- 1/2" BSP outlet.
- 4" (100mm), Diameter range 92-107mm. Maximum allowable back pressure 29psi (1.97bar).
- 6" (150mm), Diameter range 140-165mm. Maximum allowable back pressure 24psi (1.62bar).

CODE	Description	Unit	4+	1+
MON1378DP	4" Nylon Drain Plug	1	9.95	10.75
MON1379DP	6" Nylon Drain Plug	1	13.75	14.75

### Monument 11 Bar Mains Water Press Test Kit



- BSP thread for fitting to taps.
- 11 bar maximum.
- Tri-Scale kPa psi bar.

CODE	Description	Unit	4+	1+
MON1510TK	Mains Water Test Kit	1	15.95	16.50

### Monument Drain Air Test Kit



- Use the kit to carry out an air test to 100mm wg pressure (10mb) on drains.
- Contents: U Gauge; hand bellows pump; 1/2". BSP and 1". BSP nipple caps; tee piece; 3 x 2ft. lengths of rubber hose.

CODE	Description	Unit	1+
MON174ATK	Drain Air Test Kit	1	55.50

### Monument Test Plug Set



- Used for blocking off small pipes such as copper for dry testing prior to commissioning.
- 2 of each 1370B 15mm, 1371E 22mm, 1372H 28mm.

CODE	Description	Unit	1+
MON1369PS	Test Plug Set 15/22/28mm	1	24.25

## P.T.F.E. Tape for Water Pack of 10



- A non-adhesive tape for use with threaded fittings on all types of water pipes, compressed air cooling and hydraulic systems.
- WRAS and EN751-3 approved.
- Complies with BS7786 1995 Grade L.

CODE	Description	Unit	4+	1+
PTF121WAT	Water-12mm x 12m	Pack of 10	4.75	4.95

## P.T.F.E Tape - Gas



- PTFE gas tape is a non-adhesive tape for use with threaded fittings and compression joints on all types of gas pipes, including natural gas and liquid carrying pipework.
- For use with BS 21 threads up to 2 in.
- Satisfies BG C IM/16, BS6974: 1989 and BS5292 Type C tests.
- Non Flammable (ASTM D-653 – D470).

CODE	Description	Unit	10+	1+
PTF130GAS	Gas - 12mm x 5m	1	0.70	0.75

## Plumbers Solder



- A high quality UK made solid solder, available as either standard or lead-free alloy.
- Standard -70% Tin and 30% Lead. Diameter 3.0mm.
- Lead-free -99% Tin and 1% Copper. Diameter 3.25mm.

CODE	Description	Unit	4+	1+
SLD250PLM	Standard 250g	1	7.95	8.95
SLD500PLM	Standard 500g	1	14.95	16.95
LFS250PLM	Lead-free 250g	1	13.45	14.05
LFS500PLM	Lead-free 500g	1	24.45	25.60

## Self Ignition Gas Torch Head



- Swirl flame for optimum efficiency and maximum heat output.
- Convenient trigger ignition provides instant start up.
- Trigger safety catch and lock for continuous operation.
- Operates on Propane or MAPP gas for extra hot flame.
- This torch is ideal for soft soldering and brazing operations.

CODE	Description	Unit	4+	1+
GTH345GAS	Torch Head	1	61.25	65.50

## Magna Gas Cylinders



- Disposable canisters with self sealing valves.
- Available filled with either Propane or extra hot Mapp Gas.

### Propane Max Heat 954°C

CODE	Description	Unit	12+	4+	1+
PRP400GAS	14oz/400g	1	10.00	10.70	11.20

### Mapp Gas Max Heat 1149°C

CODE	Description	Unit	12+	4+	1+
MAP435GAS	453 16oz/435g	1	12.00	12.65	13.45

## LA-CO Soldering Flux



- Non-acid, non-toxic soldering flux paste
- Cleans as it solders
- WRAS approved.

Lead-free	Description	Unit	4+	1+
SFX125PST	Soldering Flux 125g	1	6.25	6.75
SFX475PST	Soldering Flux 475g	1	16.50	17.50

## Copper End Feed Fittings

- For use with water, oil and gas systems.
- Suitable for drinking water in both hard and soft water areas.



### Copper End Feed Elbow 90°

CODE	Description	Unit	100+	10+	1+
CEF015ELB	15mm	1	0.25	0.30	0.30
CEF022ELB	22mm	1	0.65	0.70	0.75
CEF028ELB	28mm	1	1.25	1.30	1.40



### Copper End Feed Tee

CODE	Description	Unit	100+	10+	1+
CEF015TEE	15mm	1	0.50	0.55	0.60
CEF022TEE	22mm	1	1.30	1.35	1.45
CEF028TEE	28mm	1	2.30	2.40	2.60



### Copper End Feed Straight Coupling

CODE	Description	Unit	100+	10+	1+
CEF015CPL	15mm	1	0.15	0.20	0.25
CEF022CPL	22mm	1	0.40	0.45	0.50
CEF028CPL	28mm	1	0.80	0.85	0.90



### Copper End Feed Reducer

CODE	Description	Unit	100+	10+	1+
CEF221RDR	22 x 15mm	1	0.45	0.50	0.60
CEF281RDR	28 x 15mm	1	0.85	0.90	0.95
CEF282RDR	28 x 22mm	1	0.80	0.85	0.90

### End Feed Fittings

- For use with water, oil and gas systems.
- Suitable for drinking water in both hard and soft water areas.



#### End Feed Street Elbow

CODE	Description	Unit	100+	10+	1+
CEF015STE	15mm	1	0.30	0.35	0.40
CEF022STE	22mm	1	0.75	0.80	0.85



#### End Feed Bent Tap Connector

CODE	Description	Unit	10+	1+
CEF151BTC	15 x 1/2"	1	1.05	1.10
CEF223BTC	22 x 3/4"	1	1.85	1.95

### Solder Fittings

- Integral solder fittings for copper tube. Ideal for use in confined spaces.
- For use with water, oil and gas systems.
- Suitable for drinking water in both hard and soft water areas.



#### Solder Ring Coupling

CODE	Description	Unit	100+	10+	1+
CSR015CPL	15mm	1	0.40	0.45	0.50
CSR022CPL	22mm	1	0.80	0.85	0.90
CSR221CPL	22 x 15mm	1	1.10	1.15	1.25



#### End Feed 45° Elbow

CODE	Description	Unit	100+	10+	1+
CEF451ELB	15mm	1	0.45	0.50	0.55
CEF452ELB	22mm	1	0.75	0.80	0.85



#### End Feed Wall Plate Elbow

CODE	Description	Unit	10+	1+
CEF151WPE	15 x 1/2"	1	1.65	1.75



#### Solder Ring Fitting Reducer

CODE	Description	Unit	100+	10+	1+
CSR221RDR	22 x 15mm	1	0.65	0.70	0.75



#### End Feed Reducing Coupling

CODE	Description	Unit	100+	10+	1+
CEF221CPL	22 x 15mm	1	0.60	0.65	0.70
CEF282CPL	28 x 22mm	1	0.95	1.05	1.15



#### End Feed Reduced Tee

CODE	Description	Unit	10+	1+
CEF281RTE	28 x 28 x 15mm	1	2.10	2.20
CEF282RTE	28 x 28 x 22mm	1	2.10	2.20
CEF215RTE	22 x 15 x 22mm	1	1.40	1.50
CEF221RTE	22 x 22 x 15mm	1	1.05	1.10



#### Solder Ring Elbow

CODE	Description	Unit	100+	10+	1+
CSR015ELB	15mm	1	0.50	0.55	0.60
CSR022ELB	22mm	1	1.10	1.15	1.25



#### End Feed Straight Tap Connector

CODE	Description	Unit	10+	1+
CEF151STC	15 x 1/2"	1	0.75	0.80
CEF153STC	15 x 3/4"	1	1.40	1.50
CEF223STC	22 x 3/4"	1	1.45	1.55



#### End Feed Cap End

CODE	Description	Unit	10+	1+
CEF015END	15mm	1	0.30	0.35
CEF022END	22mm	1	0.45	0.50



#### Solder Ring 45° Elbow

CODE	Description	Unit	100+	10+	1+
CSR451ELB	15mm	1	0.85	0.90	0.95
CSR452ELB	22mm	1	1.50	1.65	1.80

## Solder Fittings continued



### Solder Ring Tee

CODE	Description	Unit	100+	10+	1+
CSR015TEE	15mm	1	0.85	0.90	0.95
CSR022TEE	22mm	1	1.95	2.10	2.20
CSR221RTE	22 x 22 x 15mm	1		1.65	1.75
CSR152RTE	22 x 15 x 15mm	1		1.85	1.95

### Compression Female Coupling

CODE	Description	Unit	10+	1+
BCF151FCL	15 x 1/2"	1	1.15	1.25
BCF153FCL	15 x 3/4"	1	1.75	1.85
BCF223FCL	22 x 3/4"	1	1.70	1.80

### Compression Straight Tap Connector

CODE	Description	Unit	10+	1+
BCF151TPC	15 x 1/2"	1	1.85	1.95
BCF153TPC	15 x 3/4"	1	2.40	2.50
BCF223TPC	22 x 3/4"	1	3.10	3.30



### Solder Ring Cap End

CODE	Description	Unit	10+	1+
CSR015END	15mm	1	0.85	0.90
CSR022END	22mm	1	1.55	1.65

### Compression Elbow

CODE	Description	Unit	10+	1+
BCF015ELB	15mm	1	1.40	1.50
BCF022ELB	22mm	1	2.40	2.60

### Compression Bent Tap Connector

CODE	Description	Unit	10+	1+
BCF151BTC	15 x 1/2"	1	2.20	2.30
BCF223BTC	22 x 3/4"	1	5.25	5.50

## Compression Fittings

- For use to connect both plastic and copper pipework in hot and cold systems.
- Fully recyclable and WRAS approved.
- High tolerance to vacuum conditions and pressure vibration makes them ideal for industrial applications.



### Compression Coupling

CODE	Description	Unit	10+	1+
BCF015CPL	15mm	1	1.25	1.35
BCF022CPL	22mm	1	2.20	2.30
BCF221CPL	22 x 15mm	1	1.95	2.10

### Compression Stop End

CODE	Description	Unit	10+	1+
BCF015END	15mm	1	0.85	0.90
BCF022END	22mm	1	1.25	1.35

- Replacement olives for compression fittings.

### Compression Copper Olives

CODE	Description	Unit	100+	10+	1+
BCF015OLV	15mm	1	0.15	0.20	0.25
BCF022OLV	22mm	1	0.30	0.35	0.40



### Compression Male Coupling

CODE	Description	Unit	10+	1+
BCF151MCL	15 x 1/2"	1	1.15	1.20
BCF153MCL	15 x 3/4"	1	1.50	1.60
BCF223MCL	22 x 3/4"	1	1.95	2.10

### Compression Tee and Reduced Tee

CODE	Description	Unit	10+	1+
BCF015TEE	15mm	1	1.95	2.10
BCF022TEE	22mm	1	3.60	3.80
BCF221RTE	22 x 22 x 15mm	1	3.30	3.50

- Replacement fibre washers for tap connectors etc.

### Compression Fibre Washers

CODE	Description	Unit	100+	10+	1+
BCF120FWS	1/2"	1	0.25	0.30	0.35
BCF340FWS	3/4"	1	0.40	0.45	0.50

### Cast Iron Fittings

- Black cast iron threaded fittings.



#### Malleable Fx F Elbow Black Fig.90

CODE	Description	Unit	10+	1+
MBF120FFE	1/2"	1	0.75	0.85
MBF340FFE	3/4"	1	0.90	0.99



#### Malleable Bush Black Fig.241

CODE	Description	Unit	10+	1+
MBF341BSH	3/4" x 1/2"	1	0.70	0.80

### Brass Stopcock BS1010



- Traditional brass stop cock with compression fittings.

CODE	Description	Unit	4+	1+
SPC015BRS	15mm	1	3.25	3.60
SPC022BRS	22mm	1	5.95	6.50

### Chrome Isolating Valve



- Chrome plated isolating valve with compression fittings.

CODE	Description	Unit	4+	1+
ISV015CHR	15mm	1	0.99	1.10



#### Malleable Mx F Elbow Black Fig.92

CODE	Description	Unit	10+	1+
MBF120MFE	1/2"	1	0.75	0.85
MBF340MFE	3/4"	1	1.10	1.20



#### Malleable Screw On Bracket Black Fig.82E

CODE	Description	Unit	10+	1+
MBF821BBK	1/2"	1	0.60	0.65
MBF823BBK	3/4"	1	0.70	0.80

### Brass MT Drain Cock Type A 1/2"



- Brass drain cock with 1/2" BSP male end, type A to BS 2879.

CODE	Description	Unit	4+	1+
DRC120BRS	1/2"	1	1.20	1.35



#### Malleable Plug Black Fig.291

CODE	Description	Unit	10+	1+
MBF140PLG	1/4"	1	0.75	0.85
MBF380PLG	3/8"	1	0.70	0.80
MBF120PLG	1/2"	1	0.65	0.75
MBF340PLG	3/4"	1	1.00	1.10

### Brass Cap



- Threaded solid brass cap.

CODE	Description	Unit	10+	1+
CAP120BRS	1/2"	1	0.40	0.45
CAP340BRS	3/4"	1	0.60	0.65

### Loctite 55 Pipe Sealing Cord



- Designed to seal metal and plastic pipes and fittings.
- No cure time - an immediate, full pressure seal.

CODE	Description	Unit	4+	1+
LCT050PSC	50m	1	4.95	5.25
LCT160PSC	160m	1	10.50	11.50

### Brass MT Drain Cock Type A 15mm



- Brass drain cock with a 15mm capillary male end, type A to BS 2879.

CODE	Description	Unit	4+	1+
DRC015BRS	15mm	1	0.95	1.05



#### Malleable Socket Black Fig.270

CODE	Description	Unit	10+	1+
MBF120SKT	1/2"	1	0.65	0.75
MBF340SKT	3/4"	1	0.85	0.95

## Brass Long Tail Drain Cock Type A 15mm



- Brass drain cock with a 15 mm, push-fit, long tail capillary male end, type A to BS 2879.

CODE	Description	Unit	4+	1+
DRC015LTL	Long	1	3.05	3.35

## Single Check Valve



- Brass, steel and plastic construction. Suitable for water.

CODE	Description	Unit	4+	1+
CHV015SNG	15mm	1	1.50	1.65

## Double Check Valve



- Brass, steel and plastic construction. Suitable for water.

CODE	Description	Unit	4+	1+
CHV015DBL	15mm	1	1.80	1.95

## Brass Gate Valve



- Brass gate valve for water systems only.
- Compression connections.

CODE	Description	Unit	4+	1+
GTV150BRS	15mm	1	2.75	2.95
GTV220BRS	22mm	1	3.75	3.95

## Lever Ball Valve



- For oil or water systems ¼ turn operation.
- With compression fittings.

CODE	Description	Unit	4+	1+
LBV015BAL	15mm	1	3.50	3.95
LBV022BAL	22mm	1	4.95	5.50

## Braided Tap Connector



- Stainless steel braided EPDM rubber flexible connectors.
- Suitable for potable and non-potable water application.

CODE	Description	Unit	4+	1+
BTC151BRD	15 x 1/2"	1	1.35	1.50
BTC153BRD	15 x 3/4"	1	1.60	1.75
BTC223BRD	22 x 3/4"	1	2.35	2.60

## Xpress S1 Straight Coupling



- Press-fit coupling suitable for jointing copper.
- Manufactured to BS 8537 and approved to the new BS 8537 for Gas, Water and WRAS.
- Other fittings available on request.

CODE	Description	Unit	10+	1+
XPS015CPL	15mm	1	1.70	1.85
XPS022CPL	22mm	1	2.75	2.99

## Chrome Angled Rad Valve



- Chrome-plated brass finish.
- Positive shut-off.

CODE	Description	Unit	4+	1+
RDV151CHR	15mm x 1/2"	1	2.65	2.95

## Single Radiator



- Includes compact radiator, wall mounting brackets, vents and plugs and instructions.
- White powder-coated finish.
- Built using advanced production technology and top quality materials.
- Other sizes available on request.

CODE	Description	Unit	2+	1+
RAD454SNG	450 x 400mm	1	22.95	25.25

## Plastic Snap In or Wrap On Clip Pack of 100



- Polypropylene single snap in clip for 15mm pipe.
- No.8 screw fixing.

CODE	Description	Unit	10+	1+
PCP015SNP	15mm	Pack of 100	3.95	4.50
PCP215SNP	15mm	Pack of 100	8.95	9.95
PCP015WRP	15mm	Pack of 100	12.50	13.75
PCP022WRP	22mm	Pack of 100	16.95	18.50

### Altecnic Mixing Valve



- Failsafe thermostatic mixing valve has been specifically designed and manufactured to meet the requirements of the latest national health service.
- With compression fittings.

CODE	Description	Unit	2+	1+
ALT015MXV	15mm	1	37.95	41.75

### Backersafe Immersion Heater



- Controls eliminate the risk of boiling water.
- Manufactured to the latest Legislation of BSEN60335-2-73.

CODE	Description	Unit	2+	1+
IMH117STT	11"	1	14.95	16.50

### Mercia Bath Tap



- Traditional screw down operational valves and a smart chrome finish.
- Suitable for dual pressure operation.

CODE	Description	Unit	2+	1+
BHT340HOT	Hot	1	10.75	11.95
BHT340CLD	Cold	1	10.75	11.95

### Eres Automatic By-Pass Valve Angled



- Designed to prevent a pump from working against a closed circuit.
- Maximum pressure: 10 bar.

CODE	Description	Unit	2+	1+
BPV022AUT	22mm	1	9.95	10.95

### Mercia Basin Tap



- Traditional screw down operational valves and a smart chrome finish.
- Suitable for dual pressure operation.

CODE	Description	Unit	2+	1+
BNT120HOT	Hot	1	9.75	10.75
BNT120CLD	Cold	1	9.75	10.75

### Trojan Granada II Bath



- TContemporary design bath in white finish constructed using 8mm acrylic for durability.
- Fitted with hand grips and includes legs for height adjustment.
- Exceeds the British BS4305 standard.

CODE	Description	Unit	2+	1+
BTH157WHT	1500mm	1	149.50	164.95
BTH177WHT	1700mm	1	149.50	164.95

### Reliance Ausimix Mixing Valve



- Large outlet chamber for rapid, reliable, thermal shutdown.
- Temperature adjustment tool in the cap, no key required.
- Dual approved for both TMV2 and TMV3 applications.

CODE	Description	Unit	2+	1+
REL215MXV	15mm	1	38.50	42.50

### Basin 2 Tap Hole Basin Pedestal



- Strong durable 2 hole basin.
  - 550mm wide.
  - Pedestal for use with basin PED552WHT.
  - Made From White Vitreous China.
- Taps not included.*

CODE	Description	Unit	2+	1+
BAS552WHT	550mm	1	35.95	39.50
PED555WHT	Pedestal	1	34.95	38.50

### 5-Star Bath Waste and Overflow



- Universal bath waste and overflow to suit the Trojan Granada.
- Fitting size 1½".

CODE	Description	Unit	2+	1+
BWT112SET	Waste & Overflow	1	2.80	3.10

## Mercia Sink Tap High Neck



- BTraditional screw down operational valves and a smart chrome finish.
- Suitable for dual pressure operation.

CODE	Description	Unit	2+	1+
BTP120HOT	Hot	1	12.50	12.95
BTP120CLD	Cold	1	12.50	12.95

## Lexin Inset Sink Stainless Steel



- Stainless steel single bowl inset sink in a bright finish.
- Left or right hand drainer with 2 tap holes.
- Does not include taps or waste kit.

CODE	Description	Unit	2+	1+
SNK950LTH	Left Hand	1	39.95	45.00
SNK950RTH	Right Hand	1	39.95	45.00

## Overflow Knuckle Bend



- Easy to fit and adjust.
- Manufactured in polypropylene.

CODE	Description	Unit	10+	1+
OFW900WHT	90 degree	1	1.35	1.50
OFW450WHT	45 degree	1	1.45	1.60

## WC Pan Close Coupled



- Attractively manufactured from white vitreous china Conforms to BS EN997.
- Requires separate purchases of a cistern and seat.

CODE	Description	Unit	2+	1+
WCP200WHT	Pan only	1	79.50	87.50

## WC Cistern Close Coupled Top Flush



- White vitreous china material ensures durability.
- To suit WC pan WCP200WHT.

CODE	Description	Unit	4+	1+
WCC300WHT	Cistern only	1	34.95	38.50

## Celmac Emerald Double Flap Toilet Seat



- Universal fit, compatible with most modern and traditional pottery.
- Heavy weight white thermoplastic seat and cover.
- Conforms BS1254 TYPE 2, made in the UK.

CODE	Description	Unit	2+	1+
DFS200WHT	White	1	12.00	13.25

## Pan Connector Straight Short



- White EVA pan connector with offset Inlet seal ensures tight connection to the pan.

CODE	Description	Unit	2+	1+
PCN200STR	200 - 350mm	1	7.05	7.75

## Pan Connector 90° Short



- White EVA pan connector with offset Inlet seal ensures tight connection to the pan.

CODE	Description	Unit	2+	1+
PCN330ANG	90 Degree	1	9.50	10.50

## Offset Pan Connector



- White EVA pan connector with offset Inlet seal ensures tight connection to the pan.

CODE	Description	Unit	2+	1+
PCN1000FF	Offset	1	3.10	3.40



### Plate Switch 1 Gang



- Robust square edged design with a slim profile.
- Inlaid red rocker indicator.
- Colour-coded captive terminals.
- Twin earth.

CODE	Description	Unit	10+	1+
PSW101WAY	1 Gang 1 Way	1	1.35	1.45
PSW102WAY	1 Gang 2 Way	1	1.50	1.60

### Socket Switched 1 Gang



- Robust square edged design with a slim profile.
- Inlaid red rocker indicator.
- Colour-coded captive terminals.
- Twin earth.

CODE	Description	Unit	10+	1+
SSW101SPL	1G Single Pole	1	2.30	2.50
SSW102DPL	1G Double Pole	1	2.40	2.60

### Cooker Control Unit 13A Switched



- Robust square edged design with a slim profile.
- Flush power LED and inlaid red rocker indicator.
- Colour-coded captive terminals.
- Twin earth.

CODE	Description	Unit	10+	1+
SWS670CKR	Cooker Switch	1	9.75	10.50

### Plate Switch 2 Gang



- Robust square edged design with a slim profile.
- Inlaid red rocker indicator.
- Colour-coded captive terminals.
- Twin earth.

CODE	Description	Unit	10+	1+
PSW202WAY	2 Gang 2 Way	1	2.20	2.40

### Socket Switched 2 Gang



- Robust square edged design with a slim profile.
- Inlaid red rocker indicator.
- Colour-coded captive terminals.
- Twin earth.

CODE	Description	Unit	10+	1+
SSW201SPL	2G Single Pole	1	2.90	3.10
SSW202DPL	2G Double Pole	1	3.10	3.40

### Single Plate Switched Double Pole



- Robust square edged design with a slim profile.
- Flush power LED and inlaid red rocker indicator.
- Colour-coded captive terminals.
- Twin earth.

CODE	Description	Unit	10+	1+
PSW102DPL	Double Pole Switch	1	6.50	6.95

### Plate Switch 3 Gang



- Robust square edged design with a slim profile.
- Inlaid red rocker indicator.
- Colour-coded captive terminals.
- Twin earth.

CODE	Description	Unit	10+	1+
PSW302WAY	3 Gang 2 Way	1	3.20	3.50

### Flex Outlet Switched



- Robust square edged design with a slim profile.
- Flush power LED and inlaid red rocker indicator.
- Colour-coded captive terminals.
- Twin earth.

CODE	Description	Unit	10+	1+
SFX102DPL	Flex Outlet	1	4.50	4.90

### Surface Pattress Box 1 Gang 19mm, 32mm & 45mm



- Surface boxes have multiple knock-outs.
- Manufactured to BS 5733.

CODE	Description	Unit	10+	1+
SPB119BOX	1 Gang 19mm	1	0.85	0.90
SPB132BOX	1 Gang 32mm	1	0.85	0.90
SPB145BOX	1 Gang 45mm	1	1.45	1.55

### Plate Switch Fan Isolator



- Robust square edged design with a slim profile.
- Flush power LED and inlaid red rocker indicator.
- Colour-coded captive terminals.
- Twin earth.

CODE	Description	Unit	10+	1+
PSW915FAN	Fan Isolator	1	3.90	4.20

### Fused Connection Unit Switched



- Robust square edged design with a slim profile.
- Flush power LED and inlaid red rocker indicator.
- Colour-coded captive terminals.
- Twin earth.

CODE	Description	Unit	10+	1+
FSW950UNT	Fused Connection	1	3.50	3.80

### Surface Pattress Box 2 Gang 32mm & 45mm



- Surface boxes have multiple knock-outs.
- Manufactured to BS 5733.

CODE	Description	Unit	10+	1+
SPB232BOX	2 Gang 32mm	1	1.40	1.50
SPB245BOX	2 Gang 45mm	1	1.95	2.10

## Blank Plate 1 Gang



- Robust square edged design with a slim profile.

CODE	Description	Unit	10+	1+
BPT100GNG	1 Gang	1	0.95	1.05

## Blank Plate 2 Gang



- Robust square edged design with a slim profile.

CODE	Description	Unit	10+	1+
BPT200GNG	2 Gang	1	1.20	1.30

## Blank Connection Unit 10 Way Plate 2 Gang



- Robust square edged design with a slim profile.
- Double gang width pattress box and cover with 10 way connection strip.

CODE	Description	Unit	10+	1+
CNU010WAY	10 Way	1	5.50	5.95

## Junction Boxes



- Selective entries indicated by numbers and symbols on rotating cover.
- Manufactured to BS EN60670.

CODE	Description	Unit	10+	1+
JNB303WAY	3 Way 30A	1	1.95	2.10
JNB204WAY	4 Way 20A	1	1.55	1.70

## Fuses Pack of 10



- Standard plug top fuse Manufactured to BS 1362

CODE	Description	Unit	4+	1+
FUS003PAK	3A	Pack of 10	0.35	0.40
FUS013PAK	13A	Pack of 10	0.30	0.35

## Dry Lining Box 1 Gang



- Plastic box with knock-outs.
- Manufactured to BS 5733.

CODE	Description	Unit	10+	1+
SBX135DYL	1 Gang 35mm	1	0.65	0.70
SBX147DYL	1 Gang 47mm	1	0.85	0.90

## Dry Lining Box 2 Gang



- Plastic box with knock-outs.
- Manufactured to BS 5733.

CODE	Description	Unit	10+	1+
SBX235DYL	2 Gang 35mm	1	0.90	0.95
SBX247DYL	2 Gang 47mm	1	1.55	1.65

## Metal Box 1 Gang



- Galvanised steel box with knock-outs.
- Manufactured to BS 60670-1.

CODE	Description	Unit	10+	1+
SBX125STL	1 Gang 25mm	1	0.55	0.60
SBX135STL	1 Gang 35mm	1	0.75	0.80

## Metal Box 2 Gang



- Galvanised steel box with knock-outs.
- Manufactured to BS 60670-1.

CODE	Description	Unit	10+	1+
SBX225STL	2 Gang 25mm	1	0.75	0.80
SBX235STL	2 Gang 35mm	1	0.95	1.05

**Grommet Open**  
Pack of 100



- Open type grommet manufactured from PVC.
- Chemical resistant.

CODE	Description	Unit	10+	1+
GRM125PAK	25mm	Pack of 100	3.75	

**Pendant Set**  
6" or 9"



- Set includes rose, flex and lampholder.
- Eight in-line terminals all with captive screws.
- 0.7mm heat resistant pendant flex.
- Manufactured to BS67 & BS EN 61184.

CODE	Description	Unit	10+	1+
PDT600SET	6"	1	2.50	2.70
PDT900SET	9"	1	2.90	3.10

**Battern Lamp Holder**  
3 Terminals HO Skirt



- Battern lamp holder with HO skirt.
- 3 terminals.

CODE	Description	Unit	10+	1+
LPH753HSK	Battern Lamp Holder	1	2.70	2.95

**T&E Cable Clips**  
Pack of 50 or 100



- Grey clips made from impact resistant UV stabilised polypropylene.
- Safety nail bends before breaking - hardened and zinc coated.
- Temperature range -40°C to 80°C.

CODE	Description	Unit	4+	1+
CCP110TWE	1mm	Pack of 100	1.15	1.25
CCP115TWE	1.5mm	Pack of 100	1.15	1.25
CCP250TWE	2.5mm	Pack of 50	1.25	1.35

**Lamp Holder, Cord Grip with Short Skirt**



- Lamp holder with cord grip and short skirt.
- Moulded in robust, fully insulated plastic.
- Manufactured to BS EN 61184.

CODE	Description	Unit	10+	1+
LPH720SSK	Lamp Holder	1	1.25	1.35

**Push-Bar Switched Lamp Holder**



- Lamp holder with push-bar switch.
- 1/2" 26 BSB threaded entry with short skirt.

CODE	Description	Unit	10+	1+
LPH252PBR	Switched	1	2.90	3.10

**Connector Strips**  
Pack of 10



- Fully backed out screws to speed installations.
- Nominal voltage 400V and maximum continuous temperature rating 80°C.
- Manufactured to BS EN 60998 2-1.

CODE	Description	Unit	1+
CNS005PAK	5A	Pack of 10	10.50
CNS015PAK	15A	Pack of 10	15.00

**Ceiling Rose 3"**



- Cover moulded in satin finish urea.
- Eight in-line terminals all with captive screws.
- Base moulded in clear polycarbonate.
- Manufactured to BS EN 60669-01.

CODE	Description	Unit	10+	1+
CRS300PLS	3"	1	1.50	1.60

**Ceiling Switch**  
6A 1 Way



- Surface mounted ceiling switch 6A 1 way.
- Diameter 76mm x 43mm with 1.5m of cord.

CODE	Description	Unit	10+	1+
CLS061WAY	6A 1 Way	1	3.80	4.10

## Metal Consumer Unit



- Metal consumer unit which complies with 17th Edition Wiring Regulations BS 7671.
- A 10 way unit supplied complete with 2 x 63A RCD's and 10 MCB's.
- Maximum current rating: 100A, 230V AC 50Hz.

CODE	Description	Unit	4+	1+
<b>MCU010CMP</b>	10 Way	1	<b>100.95</b>	109.25

## MCB Type B



- Type B curve MCB manufactured and tested to EN/IEC 60898 standards.
- Device capable of being locked in 'ON' or 'OFF' position using a device lock.
- Positive contact status indication with 6kA breaking capacity.

CODE	Description	Unit	4+	1+
<b>MCB006BTY</b>	6A	1	<b>2.70</b>	2.90
<b>MCB010BTY</b>	10A	1	<b>2.70</b>	2.90
<b>MCB016BTY</b>	16A	1	<b>2.70</b>	2.90
<b>MCB020BTY</b>	20A	1	<b>2.70</b>	2.90
<b>MCB032BTY</b>	32A	1	<b>2.70</b>	2.90
<b>MCB040BTY</b>	40A	1	<b>2.70</b>	2.90
<b>MCB050BTY</b>	50A	1	<b>2.70</b>	2.90

## RCBO Type B



- Type B curve MCB manufactured and tested to EN/IEC 61009-1 standards.
- Device capable of being locked in 'ON' or 'OFF' position using a device lock.
- Positive contact status indication with 6kA breaking capacity.

CODE	Description	Unit	4+	1+
<b>RCB006BTY</b>	6A	1	<b>19.50</b>	20.95
<b>RCB010BTY</b>	10A	1	<b>19.50</b>	20.95
<b>RCB016BTY</b>	16A	1	<b>22.50</b>	24.25
<b>RCB020BTY</b>	20A	1	<b>17.95</b>	18.95
<b>RCB032BTY</b>	32A	1	<b>19.50</b>	20.95

## RCD



- Double Pole RCD 30mA Device capable of being locked in 'ON' or 'OFF' position using a device lock.
- Positive contact status indication.

CODE	Description	Unit	4+	1+
<b>RCD063AMA</b>	63A	1	<b>23.25</b>	25.25
<b>RCD080AMA</b>	80A	1	<b>26.25</b>	28.25

## Black Heat Shrink Tubing



- Flexible, flame-retardant polyolefin heat shrinkable tubing 2:1 ratio.
- Low smoke, abrasion resistant and in case of burning produces no dioxin.
- Excellent electrical and physical properties, including excellent acid fastness and corrosion resistance..

CODE	Description	Unit	1+
<b>HST312BLK</b>	3.2mm x 12m	1	<b>7.95</b>
<b>HST411BLK</b>	4.8mm x 11m	1	<b>8.25</b>
<b>HST610BLK</b>	6.4mm x 10m	1	<b>8.95</b>
<b>HST907BLK</b>	9.5mm x 7m	1	<b>8.50</b>
<b>HST121BLK</b>	12.7mm x 6m	1	<b>9.25</b>

## Consumer Unit Cover Blanks

Pack of 10



- Cover blanks to suit consumer unit (pack of 10, 5 x pairs).

CODE	Description	Unit	4+	1+
<b>CUC010BNK</b>	Blanks	Pack of 10	<b>2.10</b>	2.30

## Spare Label Sheets

Pack of 5



- Pack of 5 complete sheets of coloured labels.

CODE	Description	Unit	4+	1+
<b>CUL005PAK</b>	Labels	Pack of 5	<b>5.50</b>	5.95

## Rotary Isolator



- Insulated 4 pole rotary isolator with a red/yellow padlock-able handle.
- Switch interlocked with lid to prevent opening in ON position.
- Manufactured and tested to BS EN 60947-3.

CODE	Description	Unit	1+
<b>RSW204PLE</b>	20A 4-Pole	1	<b>19.50</b>
<b>RSW324PLE</b>	32A 4-Pole	1	<b>24.25</b>

## Conduit Threading Set

5 Piece



- A UK made threading set to suit the standard M20 and M25 sizes of conduit.
- Supplied with two dies, two guides and holder.

CODE	Description	Unit	5+	2+	1+
<b>CTS225SET</b>	Conduit Threading	Set of 5	<b>40.00</b>	42.20	44.50

**VDE Pro Pliers  
Combination**



- VDE/GS certified and manufactured according to EN60901.
- Heat treated chrome vanadium.
- Dual component handle.

CODE	Description	Unit	12+	6+	1+
VDE180CMB	Combination 180mm	1	13.50	14.05	14.50

**C.K RedLine VDE  
Combi Plier**



- Precision engineered jaws for exceptional grip. Extra long cutting edges for increased cutting capacity.
- Premium quality cutters which are VDE approved (conform to IEC 60900:2004) - individually tested to 10,000V for safe live working up to 1,000V and independently audited by the German VDE institute.
- Two component handle with anti-slip horns for increased comfort and safety.
- Induction hardened jaws for outstanding long term performance.

CODE	Description	Unit	4+	1+
CKT185CMB	Combi Plier 185mm	1	35.50	37.75

**C.K RedLine VDE  
Snipe Plier**



- Snipe or long pliers with serrated inside jaws for secure gripping.
- Premium quality cutters which are VDE approved (conform to IEC 60900:2004) - individually tested to 10,000V for safe live working up to 1,000V and independently audited by the German VDE institute.
- Two component handle with anti-slip horns for increased comfort and safety.
- Induction hardened jaws for outstanding long term performance.

CODE	Description	Unit	4+	1+
CKT200SPN	Snipe Plier 200mm	1	34.95	37.25

**VDE Pro Pliers  
Side Cutter**



- VDE/GS certified and manufactured according to EN60901.
- Heat treated chrome vanadium.
- Dual component handle.

CODE	Description	Unit	12+	6+	1+
VDE160SCT	Side Cutter 160mm	1	13.00	13.45	14.00

**C.K RedLine VDE  
Combicutter1**



- Side cutters with a patress screw shear for damage free cutting of 3.5mm patress screws.
- Premium quality cutters which are VDE approved (conform to IEC 60900:2004) - individually tested to 10,000V for safe live working up to 1,000V and independently audited by the German VDE institute.
- Two component handle with anti-slip horns for increased comfort and safety.
- Induction hardened alloy steel jaws for outstanding long term performance.

CODE	Description	Unit	4+	1+
CKT100CBC	Combicutter1 160mm	1	38.95	41.50

**Pro Ratchet Crimping Plier**



- For crimping open cable insulated terminals.
- The head has colour coded recesses of red, blue and yellow for different insulated terminals.
- Made from high quality carbon steel with a hardened black oxide finish to ensure maximum strength and durability.
- A high compression pressure and an adjustment mechanism enable fast and effective crimping.

CODE	Description	Unit	4+	1+
ECL222RCP	Crimping Pliers	1	14.95	16.95

**VDE Pro Pliers  
Long Nose**



- VDE/GS certified and manufactured according to EN60901.
- Heat treated chrome vanadium.
- Dual component handle.

CODE	Description	Unit	12+	6+	1+
VDE160LGN	Long Nose 160mm	1	11.50	12.10	13.00

**C.K RedLine VDE  
Combicutter3**



- Wire stripping notches for effortless and damage free stripping of 1.5 and 2.5mm<sup>2</sup> wire. Wire bending anvil for quick and damage free doubling back of copper wire. Patress screw shear for damage free cutting of 3.5mm patress screws.
- Premium quality cutters which are VDE approved (conform to IEC 60900:2004) - individually tested to 10,000V for safe live working up to 1,000V and independently audited by the German VDE institute.
- Two component handle with anti-slip horns for increased comfort and safety.
- Induction hardened jaws for outstanding long term performance.

CODE	Description	Unit	4+	1+
CKT300CBC	Combicutter3 160mm	1	47.50	50.50

**Digital Multimeter**



- A low cost LCD digital manual range multimeter which offers excellent value for educational use.
- 20 ranges including transistor test, 10A current test, audible continuity test, diode test, square wave 50Hz frequency test and overload protection.
- Robust ABS housing, with protective yellow rubberised holder.
- Supplied complete with safety test leads, battery and instructions.
- Designed in accordance with IEC1010 600V Cat II.

CODE	Description	Unit	4+	1+
MLM830DGT	Digital Multimeter	1	12.95	14.75

Electrical

## VDE Pro Screwdriver Set 8 Piece



- Premium quality 1000V insulated screwdriver set.
- VDE/GS certified and manufactured according to EN60900.
- 2.5 x 75mm, 4 x 100mm, 5.5 x 125mm, 6.5 x 150mm, PH0 x 60mm, PH1 x 80mm, PH2 x 100mm and 3 x 70mm voltage tester.

CODE	Description	Unit	4+	1+
VDE800SST	8 Piece Set	1	26.95	28.00

## Stanley FatMax VDE Screwdriver Set 10 Piece



- Soft grip handle gives the perfect combination of great grip plus reduced fatigue
- Heavy-duty plastic sheath running the length of the bar. 10 Piece Set consists of: 3 x Parallel:- 2.5mm x 50mm, 3.5mm x 75mm, 5.5 mm x 150mm. 3 x Phillips:- PH0 x 75mm, PH1 x 100mm, PH2 x 125mm. 3 x Pozidriv:- PZ0 x 75mm, PZ1 x 100mm, PZ2 x 125mm. 1 x Voltage Tester.

CODE	Description	Unit	1+
STA562573	VDE Screwdriver Set	10 Piece	40.00

## C.K Dextro VDE Screwdriver Set 5 Piece



- Premium quality Chrome Vanadium steel blade for exceptional strength and durability.
- VDE approved - individually tested to 10,000v for safe live working up to 1,000v.
- Contents: slotted parallel, 2.5 x 75mm, 4.0 x 100mm, 5.5 x 125mm, PZ No.1 x 80mm & PZ2 x 100mm.

CODE	Description	Unit	4+	1+
CKT501SET	PZ Set	5 Piece	37.75	39.75

## Stanley VDE Screwdrivers



- The Stanley Fat-Max Screwdrivers are a professional range, manufactured in Europe to an exacting standard. The colour coded split-proof handle features a soft grip for increased torque. The handle is moulded directly onto the chrome vanadium blade to give a virtually unbreakable bond.
- Insulated to 1000V

CODE	Description	Unit	4+	1+
STA065410	Parallel slotted 2.5 x 50mm	1	4.90	5.25
STA065411	Parallel slotted 3.5 x 75mm	1	5.50	5.95
STA065412	Parallel slotted 4 x 100mm	1	6.25	6.75
STA065413	Parallel slotted 5.5 x 150mm	1	7.25	7.95
STA065414	Phillips No.0 x 75mm	1	6.25	6.75
STA065415	Phillips No.1 x 100mm	1	6.95	7.50
STA065416	Phillips No.2 x 125mm	1	8.95	9.75
STA065417	Pozi No.0 x 75mm	1	6.25	6.75
STA065418	Pozi No.1 x 100mm	1	6.95	7.50
STA065419	Pozi No.2 x 125mm	1	8.25	8.95

## C.K Dextro VDE Screwdrivers



- A premium quality safety screwdriver range which is VDE approved - individually tested to 10,000V for safe live working up to 1,000V.
- Premium quality Chrome Vanadium steel blade for exceptional strength and durability.
- Long fine neck for precise control and precision machined tip for an exact fit.
- Handle injection moulded directly to blade giving the ultimate bond.
- Conforms to IEC 60900:2004. Approved and independently audited by the German VDE institute.

CODE	Description	Unit	4+	1+
CKT060PHS	PH0 x 60mm	1	6.50	6.95
CKT180PHS	PH1 x 80mm	1	7.95	8.50
CKT210PHS	PH2 x 100mm	1	8.75	9.25
CKT060PZS	PZ0 x 60mm	1	6.95	7.50
CKT180PZS	PZ1 x 80mm	1	8.25	8.75
CKT210PZS	PZ2 x 100mm	1	9.75	10.50
CKT257SLS	2.5 x 75mm	1	5.95	6.50
CKT310SLS	3.0 x 100mm	1	6.95	7.50
CKT351SLS	3.5 x 100mm	1	6.95	7.50
CKT410SLS	4.0 x 100mm	1	8.25	8.75
CKT551SLS	5.5 x 125mm	1	8.95	9.50
CKT651SLS	6.5 x 150mm	1	9.75	10.25

## Re-threading Tool



- Precision ground, HSS tap for a clean, accurate cut and long life.
- 50mm tap length for improved access.
- Shatter resistant acetate handle.

CODE	Description	Unit	4+	1+
CKT356RTT	Re-threading Tool M3.5 x 6	1	6.95	7.50

## C.K VDE Mainstester



- VDE approved Mainstester for assured safety.
- Neon light for high visibility.
- Pocket clip.

CODE	Description	Unit	1+
CKT240MTS	Mainstester 220/250V AC	1	2.60

## CK Conduit Bush Wrench



- Innovative head design allows for all sizes of conduit bushes to be tightened / untightened even with cabling in place.
- Zinc phosphate coated, tough alloy steel for increased strength and durability.
- Soft grip, tri-lobe handle for exceptional comfort and control.

CODE	Description	Unit	4+	1+
CKT190BSH	Bush Wrench	1	13.75	14.50

### Pro VDE Cable Knife



- For scoring and stripping cables.
- 50mm hardened steel blade for increased durability.
- Anti-slip guard and protective detachable cap to maximise safety.
- VDE Certified and approved, tested to 10,000V for complete assurance of safety when working on live equipment up to 1,000V AC.

CODE	Description	Unit	4+	1+
ECL050KNF	Cable Knife	1	9.95	11.50

### Megger MFT1711 Tester



- The entry level 17th Edition tester offering CAT IV, 3 and 2-wire non trip loop testing with resistance and fault current display, frequency measurement and the largest, brightest and clearest display on the market.
- This now adds a 1kV insulation test range, Auto RCD tests, 10 mA RCD, programmable (VAR) RCD, ZMAX and true RMS voltage measurement.

CODE	Size	Unit	1+
MGR711MFT	MFT1711 Multifunction Tester	1	857.95

### Megger Voltage Tester TPT420



- Features both LCD and LED displays, the TPT420 provides both AC and DC voltage measurement - from 12 to 1000 V AC and up to 1500 V DC.
- Continuity function within the range 0 to 500 kΩ, is included.
- For added safety, continuity and voltage measurements are also accompanied by an acoustic sounder.

CODE	Description	Unit	1+
MGR420TPT	TPT420 Voltage Tester	1	98.25

### Coloured PVC Electrical Tape Pack of 10



- Professional insulation PVC tape is certified EN-60454-3.
- Flame retardant for use on electrical installations.
- 19mm X 20m supplied in reels.

CODE	Colour	Unit	4+	1+
ETP192ASS	Assorted	Pack of 10	7.30	7.75

### Megger MFT1721



- The most popular of the range of the 17th Edition testers offering all the benefits of the MFT1711, including auto RCD testing and adding phase rotation and 3-phase RCD testing.
- This now adds an additional 100V insulation test range, true RMS voltage measurement, mV sensor input and Type B RCD testing.

CODE	Size	Unit	1+
MGR721MFT	MFT1721 Multifunction Tester	1	1173.25

### Megger Digital Multimeter AV0410



- 6000 count backlit digital display.
- True RMS reading on AC mode.
- 1000 V DC / 750 V AC ranges and 10 A AC / DC ranges.
- Resistance, frequency and capacitance ranges.
- Resistance, frequency and capacitance ranges.
- CAT IV 600 V safety rating.

CODE	Description	Unit	1+
MGR410AVO	AV0410 Digital Multimeter	1	173.50

### Black PVC Electrical Tape Pack of 10



- Professional insulation PVC tape is certified EN-60454-3.
- Flame retardant for use on electrical installations.
- 19mm X 20m supplied in reels.

CODE	Colour	Unit	4+	1+
ETP192BLK	Black	Pack of 10	7.50	8.50

### Megger MFT1731



- The MFT1731 is top of the range unit which can store results in the instruments own large internal memory for 1000 test results, these can then be downloaded fully into PowerSuite once back in the office for certificate generation when the job is finished.
- When using the on-site option, the cell on the highlighted circuit on the device is automatically populated with the result.
- Completing a test certificate could not be easier.

CODE	Size	Unit	1+
MGR731MFT	MFT1731 Multifunction Tester	1	1396.95

### Megger Electrician's Multimeter AV0210



- Non-contact voltage detector, live circuit warning and weatherproof to IP54.
- 2000 count digital display.
- 1001 V DC / 750 V AC ranges and 10 A AC / DC ranges.
- Resistance, frequency, capacitance ranges, insulation and continuity.
- CAT III 600 V.

CODE	Description	Unit	1+
MGR210AVO	AV0210 Digital Multimeter	1	87.95

## Megger 1002-001 Test Leads



- Megger test leads are manufactured to exacting standards and are GS38 compliant and can be used with most brands of Test Equipment.
- 1 Pair Right angled connectors 4mm test leads (Black and Red) 1 Pair unfused probes (Red and Black) and 1 Pair crocodile clips (Red and Black).
- CAT III 1000V and CAT IV 600V.

CODE	Description	Unit	1+
MGR001WLS	1002-001 Test Leads	1	40.50

## Megger Socket Interface Adaptor



- Provides a safe and simple solution to testing insulation and continuity at a 13A UK power socket without the need to disassemble the socket and risk exposing live conductors.
- In addition, this socket interface adaptor can perform Phase-Earth or Phase-Neutral loop or impedance testing.
- Compatible with Megger's LT, LRCD and RCDT range of Loop and RCD Testers.
- Remains safe if left inadvertently connected to live supply.

CODE	Description	Unit	1+
MGR622WLS	13A Socket Interface Adaptor	1	35.50

## Megger Earth Leakage Clampmeter DCM300E



- The DCM300E Earth Leakage Clamp designed primarily to check earth leakage currents.
- Four ranges: 30 mA, 300 mA, 30 A and 300 A with a best resolution of 0.01 mA.
- Analogue-style bar graph which is very useful when monitoring changes.
- Data Hold feature and the automatic power off feature that extends the battery life.
- Exceeds the latest safety design standards IEC1010-2-32 and EMC requirements.

CODE	Description	Unit	1+
MGR300DCM	DCM300E Clampmeter	1	340.95

## Megger Non-Contact AC Voltage Detector and Torch VF3



- Non-contact detection of AC voltages from 90V to 600V at 50 or 60Hz.
- Automatic audible warning buzzer.
- Bright red voltage indicator in tip.
- Ultra-bright LED torch.

CODE	Size	Unit	1+
MGR003VFD	VF3 Voltage Detector	1	17.75

## Megger Proving Unit MPU690



- To verify the correct functioning of a two pole voltage detectors.
- Large bright LCD display showing loop resistance, fault current and test voltage.
- Phase rotation indication for verification of rotating machinery and 3-phase RCD testing for industrial applications with no earth.
- On-board data storage and Bluetooth® download.
- Rugged case with a magnetic base.

CODE	Description	Unit	1+
MGR690MPU	MPU690 Proving Unit	1	114.25

## Megger Digital Clampmeter DCM310



- The large clamp jaw enables cables to be measured up to 27mm diameter.
- Current only model - measures up to 400 A AC with low current ranges for improved resolution.
- Small pocket-size design, supplied with carry case.
- IEC61010 CAT III 600 V.

CODE	Description	Unit	1+
MGR310DCM	DCM310 Clampmeter	1	98.25

## Megger Socket Tester MST210



- A convenient, compact plug-in style tester designed to identify wiring faults at UK 13A 3-pin power sockets.
- Over 17 combinations of wiring fault can be identified including missing wires and incorrect or reversed connections.
- 2 green and 1 red LEDs for instant error reporting and fault diagnosis.
- Rugged and reliable.

CODE	Size	Unit	1+
MGR210SKT	MST210 Socket Tester	1	21.50

## Megger Fork Clampmeter DCM300



- Convenient and compact non-contact instrument designed to measure AC current up to 200 A.
- Additionally performs all the functions of a basic multimeter.
- 1V to 1000 V auto-ranging AC and DC Voltage measurement.
- Wide resistance range and continuity buzzer and diode check.

CODE	Description	Unit	1+
MGR330DCM	DCM300 Clampmeter	1	129.50

## Megger Digital Clampmeter DCM320



- The large clamp jaw enables cables to be measured up to 27mm diameter, so covering the majority of applications within the electrical system installation industry.
- Multimeter model - measures up to 400 A AC with low current ranges for improved resolution.
- 600 V AC/DC, 20 M Resistance.
- Small pocket-size design, supplied with carry case.
- IEC61010 CAT III 600 V.

CODE	Description	Unit	1+
MGR320DCM	DCM320 Clampmeter	1	115.95



**Megger  
PAT Testers**



- The PAT120 is a simple PAT tester offering Class I, Class II and power and extension lead testing with fixed pass limits; because it has two insulation test voltages it can be used to test IT and surge protected equipment.
- The PAT150 full functionality PAT tester adds to the offering Portable RCD (PRCDs) testing at 10 mA and 30 mA, separate tests for continuity, insulation, mains powered leakage testing and SELV measurements.
- The PAT150R rechargeable version is a full functionality PAT tester adds to the offering Portable RCD (PRCDs) testing at 10 mA and 30 mA, separate tests for continuity, insulation, mains powered leakage testing and SELV measurements using the quick test (QT) button, and can be used for testing fixed appliances.

CODE	Description	Unit	1+
MGR120PAT	PAT120 Portable Tester	1	491.25
MGR150PAT	PAT150 Portable Tester	1	634.25
MGR155PAT	PAT150R Portable Tester	1	681.95

**DiLog 1000 Amp AC/DC  
Digital Clamp Meter DL6402**



- A highly versatile 1000 AC/DC current reading digital clamp meter with inclusion of DC current temperature and capacitance readings.
- The slim tear shaped jaw for access in tight spaces, with a 30mm opening capacity.
- Frequency, capacitance, data hold and peak capture function.
- Temperature thermocouple and K-Type adaptor supplied
- Audible continuity with electronic overload protection.

CODE	Description	Unit	1+
DLG642DCM	DL6402 Clamp Meter	1	107.50

**DiLog Socket Tester DL1090**



- The simple and reliable test for correct socket wiring.
- Clear visual and audible indication of wiring status. LED indication of a wide range of wiring conditions.
- Designed to EN 61010 and IP30.
- Power supply: From circuit under test.

CODE	Description	Unit	1+
DLG109SKT	DL1090 DiLog Socket Tester	1	18.25

**DiLog Mini 200 Amp AC Clamp  
Meter DL6505**



- A compact clamp meter for use where access to cables is a problem with a clamp opening of 18 mm.
- A range of 10 mA to 200 A AC means the small size does not compromise on range and accuracy.
- Features a non-contact voltage indicator and a LED torch
- Data hold, max current capture.
- Auto power off.

CODE	Description	Unit	1+
DLG655DCM	DL6505 Clamp Meter	1	75.95

**DiLog CombiVolt™  
Voltage and Continuity Testers  
DL6780/DL6790**



- A three-in-one tester with a rugged housing and analogue display - fully compliant with GS38.
- Testing of AC/ DC voltages from 12 to 690 V AC/DC.
- Continuity testing with optical and acoustic indication.
- Automatic switching between voltage and continuity.
- Phase rotation test system and single pole phase indication.

CODE	Description	Unit	1+
DLG678VCT	DL6780 DiLog CombiVolt	1	47.95
DLG679VCT	DL6790 DiLog CombiVolt	1	73.95

**DiLog Mini Multimeter  
DL114**



- A mini multimeter with a high contrast 4000 count LCD display. Includes non contact voltage detection and torch.
- AC and DC voltage up to 600V, AC and DC current up to 200 mA.
- Resistance up to 20 M.
- Diode test.
- Continuity up to 150.

CODE	Description	Unit	1+
DLG114MMM	DL114 DiLog Mini Multimeter	1	35.95

**DiLog Compact Auto Ranging  
1000V Multimeter DL9206**



- Compact auto ranging digital multimeter with 6000 count LCD display.
- The high contrast 6000 LCD complete with a 61 segment analogue bar graph providing a high level clear display of measured values.
- Temperature reading in °C and °F.
- Capacitance measurement from 10pF.
- Full protection on all ranges, safety category to CAT 111 600 V.

CODE	Description	Unit	1+
DLG926ARM	DL9206 DiLog Multimeter	1	57.75

**DiLog Non-Contact Voltage  
Detector DL107**



- Non-contact voltage detector with LED torch - CAT IV 1000V safety rating.
- Optical and acoustic indication of AC voltages between 24-1000V with two selectable levels of detection.
- High Voltage Mode suitable for detecting domestic electrical supply and three-phase systems.
- Low Voltage Mode designed for testing low-voltage motors (<90V), audio systems, arc welding equipment, cables with a thick layer of insulation and other weak electromagnetic AC signals.
- Supplied with batteries

CODE	Description	Unit	1+
DLG107NVD	DL107	1	17.50

## Steel Gas Welding Rods



- A low-carbon gas welding rod for mild steel and wrought iron applications.
- Free-flowing and ideal for panels, plates and fittings.
- Copper-coated for longer shelf life.
- 2.5kg pack.

CODE	Diameter	Unit	1+
<b>WLD111ROD</b>	1.6mm	2.5kg Pack	<b>24.75</b>
<b>WLD112ROD</b>	2.4mm	2.5kg Pack	<b>23.00</b>

## Silicon Bronze Brazing Rods



- Original, multi-purpose Silver Bronze No.1 low-temperature rod for brazing of steels, cast iron, copper and its alloys.
- Use with brazing flux.
- 2.5kg pack.

CODE	Diameter	Unit	1+
<b>WLD116ROD</b>	1.6mm	2.5kg Pack	<b>98.50</b>
<b>WLD124ROD</b>	2.4mm	2.5kg Pack	<b>93.00</b>

## Brazing Flux



- Powder flux for general brazing work.
- Meets EN 1045 - FH10.
- 500g

CODE	Description	Unit	1+
<b>WLD500SBF</b>	500g Jar	1	<b>24.75</b>

## Mild Steel MIG Wire



- Copper coated mild steel MIG wire for welding mild and medium tensile steels.
- For impact toughness down to -20°C.
- 5kg roll

CODE	Diameter	Unit	1+
<b>WLD605MSW</b>	0.6mm	5.0kg Pack	<b>31.25</b>
<b>WLD805MSW</b>	0.8mm	5.0kg Pack	<b>31.50</b>
<b>WLD115MSW</b>	1mm	5.0kg Pack	<b>31.75</b>

## Aluminium MIG Wire



- An aluminium alloy with 5% silicon giving excellent flow characteristics and penetration.
- Suitable for welding duralumin, cast and wrought alloys 6063 (H9), 6061 (H20) and 6082 (H30).
- Weld will discolour if anodised.
- 0.5kg roll.

CODE	Diameter	Unit	1+
<b>WLD805ALW</b>	0.8mm	0.5kg Pack	<b>10.75</b>

## Stainless MIG Wire



- Stainless steel filler wire suitable for welding 18/8 (304) austenitic stainless steels.
- Providing good corrosion and wear resistance.
- 1kg roll

CODE	Diameter	Unit	1+
<b>WLD805SSW</b>	0.8mm	1kg Pack	<b>31.50</b>

## Soldamatic Welding Simulator



- One of the most advanced welding training systems available.
- Allows students to work with real 3D objects combined with virtual computergenerated images to give them the most realistic welding experience possible.

CODE	Description	1+
<b>SDM100STD</b>	Welding Simulator - Individual	<a href="#">See website</a>
<b>SDM500CLS</b>	Welding Simulator - Class (5)	<a href="#">See website</a>

## Arc Welding Rods



- General purpose multi-positional rutilecoated mild steel electrode with stable arc and easy-lifting slag.
- 5kg pack.

CODE	Thickness	Unit	1+
<b>WLD625ROD</b>	2.5mm	5kg Pack	<b>18.25</b>
<b>WLD632ROD</b>	3.2mm	5kg Pack	<b>17.75</b>

## Tecna Industrial Spot Welder



- An industrial 16kVA (3ph) pedal operated column spot welder with adjustable arms and chrome-copper electrode holders. Water cooled transformer, arms and electrodes.
- Microprocessor control unit TECNA TE101.
- Adjustable electrode force; a microswitch starts the welding cycle when the desired pre-set value is reached.
- Throat depth 230 - 550mm with an adjustable stroke length.

CODE	Description	Unit	1+
<b>TEC464SWL</b>	16kVA	1	<b>3325.00</b>

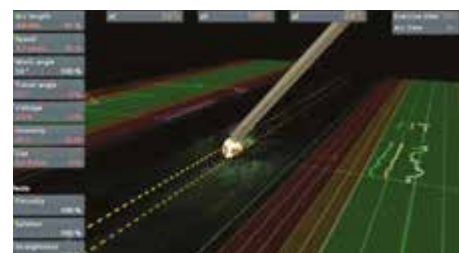

- Students can repeatedly practice techniques.
- The system can be networked and controlled by the tutor for the optimal teaching tool.

### Parweld MIG Welder Set XTE 181 Compact Auto



- Single phase compact MIG machine (230V/180A) suitable for welding mild steel, stainless steel and aluminium, supplied with earth lead, gas hose, regulator and Eco-Grip Max MIG torch.
- Full sized cabinet which can accept a gas cylinder and its large wheels for easy portability.
- Two roll drive wire feeder ensures reliable feeding of 0.6mm to 1.0mm wires with infinitely variable speed - holds 15kg wire spools.
- Built in gas valve, soft start control and overload warning indicator.
- Manufactured to IP21S, ISO/IEC 60974-1, ISO/IEC 60974-6 and RoHS Compliant with a 2 year return to base warranty.
- See website for full specification.

CODE	Discription	Unit	1+
MIG180WEL	Pro Compact	1	536.75

### Parweld TIG Welder Set XTT 182



- The XTT 182DV has a DC output and is suitable for welding alloy, non-alloy steels, stainless steel and titanium.
- TIG Mode – Materials up to 6mm can be welded with ease.
- MMA Mode – Electrodes up to 4.8mm can be used with ease Supplied with Pro-Grip Max TIG Torch and regulator.
- Manufactured to IP23S, ISO/IEC 60974-1, ISO/IEC 60974-6 and RoHS Compliant, 3 years return to base warranty.
- See website for full specification.

CODE	Discription	Unit	1+
TIG182WEL	TIG 182	1	592.25

### Parweld Plasma Cutter Set XTP 40



- The variable output of the XTP 40 makes it ideal for cutting metals up to 12mm thick where the output power can be fine-tuned to minimise dross on the cut edges.
- The pilot arc automatically re-ignites enabling easy cutting of mesh or perforated materials. Non HF ignition minimises the risk of interference with electronic systems.
- The machine is housed in a metal case with carry handle and shoulder strap.
- Supplied with Plasma Torch, hose and leads.
- Manufactured to IP23S, ISO/IEC 60974-1, ISO/IEC 60974-6 and RoHS Compliant, 3 years return to base warranty.
- See website for full specification.

CODE	Discription	Unit	1+
PSM040CUT	Plasma 40	1	1006.25

### Parweld MIG Welder Set XTM 304



- The XTM 304C is a heavy duty transformer based machine with DC Output - suitable for welding mild steel, stainless steel and aluminium.
- The 4 Roll Geared aluminium feed box ensures reliable feeding of 0.8mm and 1.6mm wires.
- 3 Phase for smooth operation along with soft start and burn back controls.
- Ideal for welding a range of materials from 1.5mm to 8.0mm, supplied with torch and regulator.
- Manufactured to IP23S, ISO/IEC 60974-1, ISO/IEC 60974-6 and RoHS Compliant, 3 years return to base warranty.
- See website for full specification.

CODE	Discription	Unit	1+
MIG304WEL	MIG 304	1	1295.00

### Parweld TIG Welder Set XTT 202P



- The XTT 202P can be used in both AC and DC modes for TIG or MMA welding allowing the welding of virtually any material.
- Square wave AC output and power pulsing maximises productivity whilst reducing heat output.
- The majority of steels can be welded in DC mode quickly using the pulse power function. The AC mode allows the welding of aluminium and magnesium alloy.
- Supplied with Pro-Grip Max TIG Torch and regulator.
- Manufactured to IP23S, ISO/IEC 60974-1, ISO/IEC 60974-6 and RoHS Compliant, 3 years return to base warranty.
- See website for full specification.

CODE	Discription	Unit	1+
TIG202WEL	TIG 202	1	1148.50

### Parweld Plasma Cutter Set XTP 63



- The variable output of the XTP 63 makes it ideal for cutting metals up to 20mm thick where the output power can be fine-tuned to minimise dross on the cut edges.
- The pilot arc automatically re-ignites enabling easy cutting of mesh or perforated materials. Non HF ignition minimises the risk of interference with electronic systems.
- The machine is housed in a metal case with carry handle and shoulder strap.
- Supplied with Plasma Torch, hose and leads.
- Manufactured to IP23S, ISO/IEC 60974-1, ISO/IEC 60974-6 and RoHS Compliant, 3 years return to base warranty.
- See website for full specification.

CODE	Discription	Unit	1+
PSM063CUT	Plasma 63	1	1098.25

## Welding Parweld Multi-Process Welder Set XTM 201 Di



- Ideal for welding a range of materials - steels, stainless steels and aluminium using MIG, DC TIG or MMA processes.
- Digital Interface – simply select your process, gas, material thickness and wire size and the machine automatically sets to the correct parameters for your job. You can then make adjustments using the control knobs on the front.
- Single phase dual voltage 110V/230V.
- Supplied with a Pro-Grip® Control Handle MIG Torch, 3m Input Cable and Earth Lead, Gas Hose, Argon Gas Regulator and 0.8mm MIG wire.
- Manufactured to IP23S, ISO/IEC 60974-1, ISO/IEC 60974-6 and RoHS Compliant, 3 years return to base warranty.
- See website for full specification.

CODE	Description	Unit	1+
MUL201WEL	Multi 201	1	998.50

## Parweld Gas Welding and Brazing Set



- A complete set suitable for light weight welding and brazing applications, supplied in a fitted aluminium case.
- Supplied with regulators for acetylene (25 Bar Single Stage 2 Gauge) and for oxygen (300 Bar Single Stage 2 Gauge), and in-line flashback arrestors for both oxygen and fuel.
- Fitted hose - oxygen and acetylene 5m .
- Welding shank with lightweight mixer and 2 nozzles.
- Set includes a round cup lighter and combination spanner.
- See website for full specification.

CODE	Description	Unit	1+
GAS302WEL	Set C	1	179.50

## Anti-splatter Spray



- A water-based product for safe use in educational establishments.
- New high Concentrate formula which is 3 times stronger than previous products.
- High heat resistance and silicon free.
- Pump spray 750ml.

CODE	Description	Unit	4+	1+
WLD750ASP	750ml	1	7.75	8.50

## Welding Curtain and Frame Complete



- Free standing steel frame.
- Supplied with a green PVC curtain.
- Includes curtain rings for mounting.
- 1.8 x 1.8m.

CODE	Description	Unit	1+
WLD181GCU	Curtain and Frame	1	86.95

## Parweld Arc Welder Set XTS 163



- The XTS 163 MMA Inverter uses latest technology to provide a compact and reliable machine, ideal for everyday applications.
- Electrodes up to 3.2mm can be used with ease.
- Supplied with electrode holder and also a TIG torch.
- When coupled to a suitable gas supply, can be used for TIG welding steel and stainless steel.
- Manufactured to IP23S, ISO/IEC 60974-1, ISO/IEC 60974-6 and RoHS Compliant, 3 years return to base warranty.

CODE	Description	Unit	1+
ARC163WEL	Arc 163	1	195.00

## Parweld Gas Cutting and Welding Set



- A Type 5 cutting and welding set, supplied in a fitted aluminium case.
- Supplied with regulators for acetylene (25 Bar Single Stage 2 Gauge) and for oxygen (300 Bar Single Stage 2 Gauge), and in-line flashback arrestors for both oxygen and fuel.
- Fitted hose - oxygen and acetylene 5m.
- Type 5 cutting attachment with a Type 5 shank and mixer, also 2 x Type 5 welding nozzles.
- Set includes a round cup lighter and combination spanner.
- See website for full specification.

CODE	Description	Unit	1+
GAS502WEL	Set E	1	229.50

## Air Cooled MIG Welding Torch 3m and 4m



- Integrated soft-grip handle.
- Enhanced wire feeding performance.
- Screwless design for rapid servicing.
- Cable supports for improved wire feed.
- Durable swan neck.
- High temperature resistant insulation.
- Contact tips manufactures using a harder and higher conductivity copper than the OEM.
- Maximum performance nozzle.

CODE	Description	Unit	1+
MIG150PRO	PRO1500	1	84.75
MIG250PRO	PRO2500	1	127.75

**Leg Vice**



- For holding metal during heavy bending and sledge hammering.

CODE	Description	Unit	1+
BFT600LGV	Leg Vice	1	450.00

**Leather Sandbag**



- Uses to form and beat metals.
- Sand filled leather bag.
- Double stitched for durability.

CODE	Description	Unit	1+
LSB200LEA	200mm/8" Diameter	1	22.75

**Lightweight Foundry Tongs**



- Versatile lightweight tongs for general hot metal use.
- 15" overall length.

CODE	Description	Unit	1+
BFT150LWT	Lightweight 15"	1	33.95

**Sieve**



- A traditional product for sieving sand prior to casting.
- No. 12 Mesh: 1/16" size holes.

CODE	Size	Unit	1+
BFT120SEV	16" diameter	1	49.95

**Anvil Single Bick 25kg**



- For Blacksmiths and metal workers alike, the hard face for supporting and shaping hot metal as it is hammered.
- Grey cast iron with a machine ground top face.
- Ground surface 215mm x 100mm.
- Overall length 380mm x 165mm high.

CODE	Description	Unit	1+
ANV250SBK	25kg	1	99.50

**Standard Close Mouth Tongs**



- Heavy duty tongs in the popular close mouth pattern.
- 18" overall length.

CODE	Description	Unit	1+
BFT180CMT	Close Mouth 18"	1	57.50

**Welded Ladle**



- Hemisphere steel ladle for scooping and pouring molten non-ferrous metals – Hemisphere is welded to handle.

CODE	Description	Unit	1+
BFT400LDL	4" dia. 24/610mm handle	1	22.95
BFT600LDL	6" dia. 30"/760mm handle	1	27.95

**Swage Block**

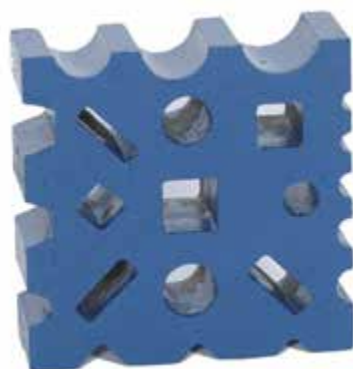

- Cast iron shape with a series of graduated shaped cavities used for finish shaping of hot metal.

CODE	Description	Unit	1+
BFT300SWB	Swage Block	1	255.00

**Double Hollowbit Tongs**



- Double Hollowbit Tongs for gripping a given diameter of round metal in both directions.

CODE	Description	Unit	1+
BFT240DHT	Double Hollowbit Tongs	1	62.50



# Workholding

---

**Clamps**  
167-170

---

**Vices**  
170-172

---

**Clamping Accessories**  
170, 172

**Boston Sash Cramps**

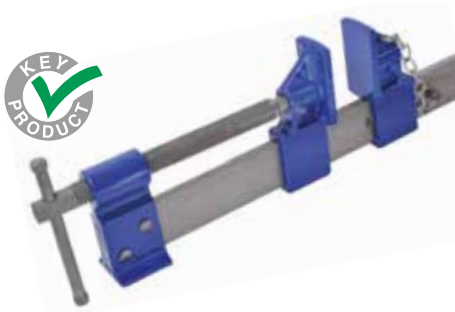

- Industrial quality.
- Flat bar of 1 1/4" x 1/4" section.
- Flat bottomed slides for standing without support.
- Two-start thread for strength and speed.



CODE	Capacity	Unit	12+	6+	1+
BST240SHC	24"/610mm	1	19.95	22.95	25.95
BST360SHC	36"/915mm	1	21.95	24.95	27.95
BST480SHC	48"/1220mm	1	23.95	26.95	29.95

**One-Handed Clamp**



- 6"/150mm capacity.
- 3 1/4"/80mm throat depth.
- Single handed operation.
- Fitted with nylon jaw pads.
- All steel construction for strength and durability.

CODE	Description	Unit	12+	4+	1+
SAC150NYL	One-handed Clamp	1	9.95	10.95	11.95

**Irwin Quick-Grip Clamp QuickChange**



- Strong Zytel body, heat treated steel bars and soft grip pads.
- Jaws can be altered from lockable to swivel.
- Clamping pressure of 135kg.
- 6" and 12" supplied as pack of 2.

CODE	Size	Unit	4+	1+
QGP150QPK	6" / 150mm	Pack of 2	33.70	37.00
QGP300QPK	12" / 300mm	Pack of 2	37.05	41.50
QGP751845	18" / 450mm	1	28.05	30.25
QGP752460	24" / 600mm	1	32.05	35.25

**Boston Tail Slide Assembly**



- Replacement sliding jaw, pin and chain assembly.
- For sash cramps the most common part to lose which then renders the cramps useless!
- It fits most of the standard UK brands.



CODE	Size	Unit	1+
SHC100SPC	Tail Slide, Pin & Chain	1	13.95

**Plastic Spring Clamps**



- Tough nylon-fibreglass body with swivel jaws.
- Strong metal clamping spring.
- The 4" size has a 1 1/2" clamping capacity and the 6" a 2" capacity.

CODE	Size	Capacity	Unit	20+	10+	1+
PSC400NYL	4"	1 1/2"	1	1.50	1.75	2.25
PSC600NYL	6"	2"	1	1.95	2.25	2.75

**Irwin Quick-Grip Clamp Mini Pack of 2**



- Strong Zytel body, heat treated steel bars and soft grip pads.
- Compact clamps are unjustly classed as mini clamps as they are only slightly smaller than the original sized product.
- 60mm depth of throat and 70kg of holding makes them a must for any woodworker.

CODE	Size	Unit	4+	1+
QGP150MPK	6"/150mm	Pack of 2	12.30	13.25
QGP300MPK	12/300mm	Pack of 2	15.20	16.25

**Aluminium Sash Cramp Pack of 10**



- Main bar is an aluminium extrusion, making a lightweight but rigid sash cramp.
- Quick action sliding jaw has a spring lock which locates in the indentations along the bar.
- Clamping pressure is applied by the steel main screw and tommy bar.

CODE	Size	Unit	4+	1+
ASC180450	18" / 450mm	Pack of 10	89.95	99.50
ASC300750	30" / 750mm	Pack of 10	105.00	115.00
ASC421075	42" / 1075mm	Pack of 10	119.95	129.50

**Quick-Action Clamps**



- Quick-action trigger mechanism, with a quick change reversible jaw for spreading.
- Strong body with soft pad jaws.
- Heat treated steel clamping bar - either 150mm or 300mm clamping capacity.
- Jaw depth 60mm.

CODE	Size	Unit	12+	4+	1+
QAC150QCH	150mm	1	5.95	6.95	7.95
QAC300QCH	300mm	1	6.95	7.95	8.95

**Irwin Quick-Grip Clamp Micro Pack of 2**



- Strong Zytel body, heat treated steel bars and soft grip pads.
- Quite small and therefore ideal for model-making and craft work.

CODE	Size	Unit	4+	1+
QGP115MPK	4 1/2" / 115mm	Pack of 2	6.70	7.25

Clamps

## Urko No. 21 F-Clamp Throat Depth 60mm



- A well engineered small F-clamp with a 60mm jaw depth and a 18mm x 7mm bar.
- The moving jaw incorporates a hardened insert to prevent slip and wear.
- Tommy bar handle and swivel pad.

CODE	Size	Unit	12+	4+	1+
URK2021F1	200mm	1	13.75	14.25	15.50
URK3021F1	300mm	1	15.25	15.95	17.25

## Urko No.3-P Industrial Clamp Throat Depth 220mm



- Professional quick action 'F' clamps with extra deep 220mm rugged cast iron jaws.
- Heavy duty 40 x 10mm section steel bar with serrations on both edges for grip.
- 220mm sliding jaw has hardened steel insert which engages the bar serrations to prevent slip.
- Non-rotating ram has a double action screw mechanism for quick clamping.

CODE	Size	Unit	12+	4+	1+
URK6223P1	600 x 220mm	1	81.95	85.95	92.95

## Plastic Bench Hook Individual or Pack of 20



- Made in UK from tough plastic – 180 x 127mm
- Suitable for right or left hand use
- The 10mm and 13mm channels have a 90 degree angle and two 45 degree angles on opposite sides.
- Designed to be butted up against a bench.

CODE	Description	Unit	10+	4+	1+
BHK913PLS	Bench Hook	1	2.95	3.30	3.70
BHK020PLS	Bench Hook	Pack of 20	29.95		

## Urko No. 3-P Industrial Clamps Throat Depth 90mm



- Professional quick action 'F' clamps with 90mm deep rugged cast iron jaws.
- Heavy duty 30 x 8mm section steel bar with serrations on both edges for grip.
- 90mm sliding jaw has hardened steel insert which engages the bar serrations to prevent slip.
- Ram has a double-action screw mechanism for quick clamping with a swivel pad.

CODE	Size	Unit	12+	4+	1+
URK2093P1	8" / 200mm	1	21.25	22.25	23.95
URK3093P1	12" / 300mm	1	23.95	25.25	27.25
URK6093P1	24" / 600mm	1	32.75	34.50	37.25

## Soft Jaw Pads Pair Accessory to suit URKO Clamps

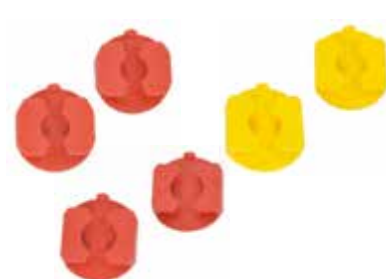

- Soft jaw pads that fit onto the jaws of the Urko clamps to protect the work surface.
- Fits no 21 F-clamp and 3-P clamps.
- Supplied in pairs.

CODE	Size	To Suit	Unit	4+	1+
URK121SJP	S	21F	2	1.40	1.60
URK130SJP	M	90mm Throat/3P	2	1.85	2.10
URK135SJP	L	120mm Throat/3P & 3V	2	2.20	2.50

## Camlock Bench Hook Pack of 10



- Small wooden bench hook with a simple cam-action workpiece clamp.
- 150 x 110mm.

CODE	Size	Unit	1+
BHK10CAM	Camlock	Pack of 10	31.95

## Urko No. 3-P Industrial Clamps Throat Depth 120mm



- Professional quick action 'F' clamps with 120mm deep rugged cast iron jaws.
- Heavy duty 35 x 8mm section steel bar with serrations on both edges for grip.
- 120mm sliding jaw has hardened steel insert which engages the bar serrations to prevent slip.
- Non-rotating ram has a double-action screw mechanism for quick clamping.

CODE	Size	Unit	12+	4+	1+
URK3123P1	12" / 300mm	1	27.75	29.25	31.50
URK6123P1	24" / 600mm	1	35.50	37.25	40.25
URK9123P1	36" / 900mm	1	42.95	44.95	48.75
URK4123P1	48" / 1200mm	1	50.95	53.50	57.75

## Bench Hook



- Traditional bench hook for support of small work on the bench.
- Overall size 250 x 130mm, all beech construction.
- Suitable for right or left hand use.

CODE	Size	Unit	10+	1+
BHK800500	Bench Hook	1	7.95	9.95

## Beech Mitre Box



- Beech construction - glued and screwed.
- Suitable for either a tenon or gents saw.
- Length 300mm x inside capacity 60mm x inside height 40mm.

CODE	Size	Unit	4+	1+
MTR640BOX	Mitre Box	1	9.95	11.95



### Adjustable Band Clamp



- Simple and effective band clamp which applies uniform pressure around an assembly of components.
- Ideal for picture frames, circular work, small boxes and for use as a light duty web clamp.
- Webbing band length 4m, width 25mm.

CODE	Size	Unit	4+	1+
ABC004025	Adj. Band Clamp	1	8.75	9.75

### Magnetic Quick Clamp



- Useful magnetic clamp for a wide range of welding, brazing, soldering or assembly jobs.
- Magnet will hold flat or round components together at angles of 45° or 90°.
- Dimensions 6" x 4".

CODE	Description	Unit	4+	1+
MQC45901M	Magnetic Quick Clamp	1	6.70	7.25

### Toggle Clamp No.101A Vertical



- Vertical.
- Holding force: 50kg
- Overall height 90mm x length 55mm.

CODE	Description	Unit	4+	1+
TGC101AVT	101A	1	5.95	7.25

### Adjustable Frame Clamp



- The steel band applies uniform clamping pressure around an assembly of components.
- Can be used for square, triangular or circular work by removing the corner pieces.
- Capacity 21/8" - 36" (55 - 900mm) square.

CODE	Description	Unit	4+	1+
TV146ADFC	Adj. Frame Clamp	1	27.50	29.75

### Drilling Machine Clamp Self Grip Type



- Highly popular machine clamp incorporating the self grip plier mechanism.
- Bolts to the machine table and the rear adjuster varies the clamping height and pressure.
- Overall length 150mm or 250mm.

CODE	Description	Unit	4+	1+
CVC600DMC	150mm Clamp	1	17.45	18.50
CVC900DMC	250mm Clamp	1	19.70	21.25

### Toggle Clamp No.201B Horizontal



- Horizontal.
- Holding force: 90kg.
- Overall height 38mm x length 140mm.

CODE	Description	Unit	4+	1+
TGC201BHZ	201B	1	6.95	7.75

### Ratchet Web Clamp

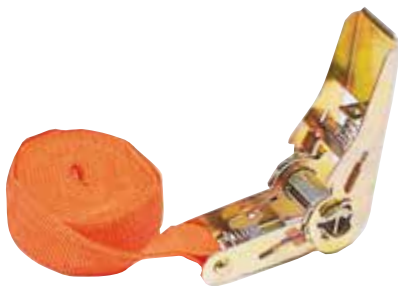

- Webbing strap for large clamping and holding operations.
- Nylon strap (1" x 15ft) is fed into the robust ratchet mechanism and pulled to a high tension.

CODE	Size	Unit	4+	1+
RWC150100	1" x 15ft	1	7.95	8.25

### Toolmakers Clamp 3" or 4"



- For holding work together when drilling, tapping and other machining operation.
- Manufactured from case hardened steel for strength.
- Fitted with a screw clip to keep the jaws in place.
- 3"/75mm has an opening of 57mm.
- 4"/100mm has an opening of 70mm.

CODE	Description	Unit	4+	1+
TMC300214	3"/75mm	1	6.50	7.25
TMC400234	4"/100mm	1	7.95	8.95

### Toggle Clamp No.225D Horizontal



- Horizontal.
- Holding force: 227kg.
- Overall height 48mm x length 170mm.

CODE	Description	Unit	4+	1+
TGC225DHZ	225D	1	8.95	10.50

## Nylon Reinforced G Clamp



- Made in the UK from strong nylon reinforced plastic with a metal screw thread.
- Plastic toggle handle and clamping pad.
- Available in 3 sizes: 25, 50 and 75mm.

CODE	Size	Unit	12+	4+	1+
GCL025NYL	25mm	1	<b>2.60</b>	2.80	3.20
GCL050NYL	50mm	1	<b>2.90</b>	3.10	3.50
GCL075NYL	75mm	1	<b>3.20</b>	3.50	3.90

## Corner Vice Aluminium



- Aluminium alloy body.
- Zinc plated steel screws with tommy bar.
- 3"/75mm clamping capacity.

CODE	Description	Capacity	Unit	4+	1+
CNV300ALU	Corner Clamp	3"/75mm	1	<b>4.95</b>	6.50

## Hand Vice



- Hand held vice for the secure clamping of small workpieces when grinding or drilling.
- Cast iron construction with steel components.
- Metal leaf spring holds jaws apart when adjusting.

CODE	Description	Unit	4+	1+
HDV050CLP	50mm/125mm	1	<b>8.95</b>	9.95

## Standard G-Cramps



- Well finished G-cramp with a malleable iron frame.
- Clean cut thread fitted with a swivel shoe.

CODE	Size	Unit	12+	6+	1+
GCL201STD	2"	1	<b>3.95</b>	4.50	4.95
GCL301STD	3"	1	<b>4.50</b>	4.95	5.50
GCL401STD	4"	1	<b>5.75</b>	6.50	7.25
GCL601STD	6"	1	<b>7.95</b>	8.95	9.95
GCL801STD	8"	1	<b>10.95</b>	12.50	13.95

## Quick Action Corner Vice



- Well designed die-cast 90° corner vice for clamping mitres and T-joints.
- Quick release screw with strong square section thread.
- Jaw width and capacity: 65mm (2½").

CODE	Description	Unit	1+
CNV6590QA	Quick Action Corner Vice	1	<b>24.25</b>

## Lynx Soft Jaws Pair

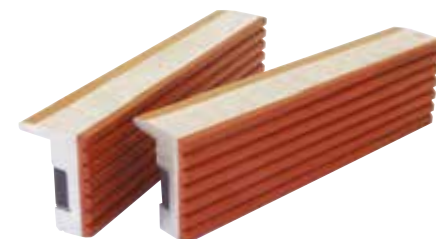

- Held in place by magnetic strip.
- Aluminium body with soft rubber facings to prevent workpiece damage.

CODE	Size	Unit	4+	1+
LYX401MSJ	4"	1	<b>7.50</b>	8.95

## Boston G-Cramp Pro 4", 6" and 8"



- Guaranteed unbreakable malleable iron frame.
- Fast action twin start rolled acme thread.
- Steel swivel shoe applies an even pressure.



CODE	Size	Unit	12+	4+	1+
GCL204PRO	4"	1	<b>9.95</b>	10.95	12.95
GCL206PRO	6"	1	<b>11.95</b>	12.95	15.25
GCL208PRO	8"	1	<b>17.95</b>	19.50	21.25

## Stanley Multi Angle Vice



- Lightweight, multiple positional vice, made from durable aluminium.
- Patented ball joint allows you to rotate your project a full 360° and lock it at any angle.
- Removable rubber jaw with a 3" opening.
- Large C-clamp attaches to work surfaces up to 2⅝"/60mm thick.

CODE	Description	Unit	4+	1+
STA183069	Multi Angle Vice	1	<b>24.50</b>	26.50

## Boston Vice Jaws Pair



- Plastic faced vice jaws suitable for most bench vices, supplied as a pair.
- For a firm grip on delicate or polishing surfaces without damage.
- Corner lugs are pliable and can be easily shaped to fit the vice.

CODE	Size	Unit	4+	1+
BST300PVJ	3"/75mm	Pair	<b>9.50</b>	10.50
BST400PVJ	4"/100mm	Pair	<b>10.75</b>	11.95
BST500PVJ	5"/125mm	Pair	<b>12.50</b>	13.95
BST600PVJ	6"/150mm	Pair	<b>13.95</b>	15.50

**Boston V150 Compact Vice**



- Similar to the V175 but incorporates an integral clamp, capacity 2 1/4"/57mm.
- Jaw width 6"/150mm, opening 5"/125mm.



CODE	Description	Unit	10+	4+	1+
BSTN150CV	V150 Compact Vice	1	29.95	33.75	37.50

**Boston V175 Compact Vice**



- Sturdy compact vice for educational use.
- Cast iron body and front plate, steel handle, main screw and slide rods.
- Jaw width 7"/175mm opening 6"/150mm.

CODE	Description	Unit	10+	4+	1+
BSTN175CV	V175 Compact Vice	1	31.95	35.95	39.95

**Record Woodworking Vice Plain Screw**



- Fitted with retractable dogs.
- Jaws have a designed 'toe-in' towards the top, providing even clamping pressure.

CODE	Description	Unit	10+	4+	1+
REC5200PD	Plain Screw 7"	1	67.50	70.80	76.75
REC5212PD	Plain Screw 9"	1	81.50	88.60	94.00

**Boston Pro Woodworking Vice Plain Screw**



- Professional vice having high quality grey cast iron body with adjustable front stop/dog giving an additional cramping facility. Available in four popular sizes.
- Steel slide rods and main screw to ensure a smooth, parallel action.
- Unbreakable nut housed beneath the body seating, to ensure the constant alignment of the screw mechanism.
- The vice with a 7" (175mm) jaw has an 8" (200mm) opening and the 9" (225mm) jaw width has a 13" (325mm) opening.

CODE	Description	Unit	10+	4+	1+
WWV700PSR	7" Jaw Width	1	63.50	71.50	79.50
WWV900PSR	9" Jaw Width	1	79.50	89.50	99.50

**Boston Pro Woodworking Vice Quick Release**



- Quick-release enables the vice to be opened and closed without using the mainscrew.
- Adjustable front stop or dog gives an additional cramping facility.
- Two steel guide rods to reduce wear and ensure a smooth parallel grip.
- Location holes are provided to fit your own wooden cheeks.

CODE	Description	Unit	10+	4+	1+
WWV700QRL	7" Jaw Width	1	75.00	85.00	95.00
WWV900QRL	9" Jaw Width	1	99.95	112.50	125.00

**Boston Model Makers Vice**



- A small sturdy vice with strong G-cramp for attachment to bench or table top.
- Serrated jaws and small anvil.
- Lockable swivel base with 50mm capacity bench mounting clamp.
- Jaw width 50mm x opening of 60mm

CODE	Description	Unit	4+	1+
MMV200212	2" Vice	1	16.95	18.95

**Boston Metalworkers' Vice**



Vices



- High quality castings with Integral anvil.
- 100mm jaw x 85mm opening.



CODE	Description	Unit	10+	4+	1+
BST100BNV	4"/100mm Jaw	1	31.95	35.95	39.95

**Boston Pro Mechanics Vice**



- Body and sliding jaw are manufactured from high quality grey cast iron.
- Precision milled slide ensures a fast, smooth operation.
- Available in four popular sizes:  
Jaw width - 3"/75mm, opening 82mm.  
Jaw width - 4"/100mm, opening 109mm.  
Jaw width - 6"/150mm, opening 168mm.  
Jaw width - 8"/200mm, opening 208mm.

CODE	Description	Unit	10+	4+	1+
ECL300MCV	3" Jaw Width	1	29.95	33.75	37.50
ECL400MCV	4" Jaw Width	1	39.95	44.95	49.95
ECL600MCV	6" Jaw Width	1	85.00	94.50	105.00
ECL800MCV	8" Jaw Width	1	155.00	175.00	195.00

**Boston V75 Table Clamp Vice**



- A portable well-made vice which is ideally suited to younger student use.
- Built-in clamp allows it to be easily and quickly attached to a work surface of up to 40mm thickness.
- Useful anvil is included on the rear of the body.
- Pipe/round bar grips are incorporated below the parallel jaws.
- Jaw width 75mm/3".



CODE	Description	Unit	10+	4+	1+
BST075TCV	V75	1	19.95	23.50	25.95

## Edubench Wooden Vice Jaws



- Beech plywood protective faces pre-drilled for fixing to a woodworking vice.
- Oiled finish and supplied with fixings.

CODE	Description	Unit	10+	4+	1+
EBS700WVJ	7"	1	9.95	10.95	12.95
EBS900WVJ	9"	1	10.95	11.95	13.95

## Cast Iron Drill Press Vice



- Cast body and jaw with machined base.
- Vee-grooved jaws with wide spaced slides for through-drilling.
- Long handle with cross-drilling for tommy bar.
- 2 sizes available:  
75mm Jaw width x 63mm opening.  
100mm Jaw width x 75mm opening.

CODE	Size	Unit	4+	1+
DMV075063	75mm x 63mm	1	25.95	27.95
DMV100075	100mm x 75mm	1	27.95	29.95

## Boston Unigrip Style Drill Press Vice



- Based on the unigrip style, these vices are excellent quality and could even be used for light milling operations.
- Screw draws smoothly up inside the handle.
- Available in 2 sizes:  
3"/75mm jaw width 58mm opening.  
4"/100mm jaw width 72mm opening.

CODE	Size	Unit	4+	1+
BSTN3UDPV	3"	1	37.95	44.50
BSTN4UDPV	4"	1	39.95	47.50

## Boston 3-Way Drill Press Vice



- An innovative high quality vice having ground faces on the base, side and end.
- Vice can be clamped in three different planes for various drilling operations.
- Ground slideways with stepped and grooved jaws.
- Jaw width 100mm with an opening of 90mm.
- Screw draws smoothly up inside the handle.

CODE	Description	Unit	2+	1+
BSTN43TWW	3-Way Vice	1	59.95	65.00

## Sekura Rotary Table

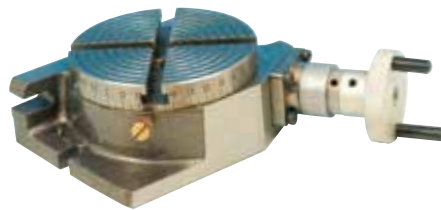

- Table diameter 6"/150mm.
- Can be mounted horizontally or vertically.

CODE	Size	Unit	1+
SEK150RTT	6"/150mm	1	199.00

## Sekura Steel Parallel Sets



- Set consists of 4 pairs of 6" long matched parallels.
- Hardened and ground for accuracy and long life.
- Height of parallels:  
1", 1 1/4", 1 1/2", and 1 3/4", all 1/2" wide.

CODE	Size	Unit	1+
SEK120SPS	1/2"/13mm Section Width	1	59.50

## Sekura Vee Blocks Pair



- Vee blocks made from cast iron and have machined surfaces. Each pair is supplied matched and numbered.
- Dimensions: L x H x W: 4" x 3" x 1 1/2"  
Capacity (diameter): 3".

CODE	Description	Unit	1+
SEK314VEB	Vee Blocks	2	28.95

## Sekura Angle Plates



- Webbed construction for rigidity and strength.
- Fully machined outside surfaces.

CODE	Size	Unit	1+
SEK433AGP	4 1/2 x 3 1/2 x 3"	1	37.95
SEK654AGP	6 x 5 x 4 1/2"	1	48.95
SEK865AGP	8 x 6 x 5"	1	66.50

## Sekura Swivel Base Machine Vice



- Enclosed screw for protection and is fitted with removable jaw plates.
- Swivel base can be removed to reduce overall height.
- Available in either 100mm or 150mm jaw width:  
100mm (4") jaw width with a jaw opening of 75mm (3 1/2").  
150mm (6") jaw width with a jaw opening of 170mm (6 1/2").

CODE	Description	Unit	1+
SEK100SMV	100mm/4"	1	175.00
SEK150SMV	150mm/6"	1	250.00



# Workplace Equipment

---

**Inspection & Security**  
174

---

**Extension Leads**  
175

---

**Workwear & PPE**  
176-180

---

**Signs & First Aid**  
181

---

**Industrial Equipment**  
182

**TILGEAR**

2023/24 ISSUE 58

## Magnetic Retriever



- Useful instrument for retrieving small ferrous articles from restricted locations.
- Pocket clip handle.
- Tip fitted with powerful magnet.
- Extending telescopically from 5" to 25".

CODE	Description	Unit	1+
RET525MAG	Magnetic Retriever	1	5.25

## Illuminated Magnifier



- Cool running 22w circular fluorescent tube surrounding the 5" lens for even illumination.
- G-crimp mounting base allows easy fitting to a bench, desk or machine.
- Magnifying lens - 3 dioptre for easy inspection of small or intricate components.
- Spring balanced arm has long 45" reach.

CODE	Description	Unit	1+
OEQ125ILM	Magnifier	1	87.25
OEQ22WILM	Spare Tube	1	14.50

## Brass Padlocks Keyed Alike



- All keys fit any of the padlocks of the same size purchased in the same batch.
- Ideal for situations where keyholders need access to all of the secured areas.
- Each padlock supplied with a set of 3 keys.
- Size: 25mm.

CODE	Size	Unit	10+	4+	1+
PAD025KAL	25mm	1	4.60	4.90	5.50
PAD032KAL	32mm	1	4.95	5.50	5.95

## Rechargeable Lantern Torch



- High-intensity torch with built-in rechargeable 3.7V 2000mAh Li-ion battery.
- Handle adjusts for conventional hold or pistol grip and the stand allows hands-free operation.
- COB LED bulb with 200 lumen output.
- Includes mains and 12V in-car chargers.
- Length 236mm.

CODE	Size	Unit	1+
TOR200RCH	Rechargeable Torch	1	35.95

## Helping Hand Magnifier



- Four double ball joints for exact positioning.
- Two alligator clips for workholding.
- 2 x glass magnifier for viewing small components.
- Heavy base for stability, chrome plated components.
- Overall sizes: Width 5", Height 5", Base 2 1/4" square.

CODE	Description	Unit	1+
OEQ060HHM	Helping Hand	1	6.95

## Long Shackle Brass Padlock



- Solid brass 40mm body with chrome-plated, hardened steel shackle and multi pin tumbler mechanism.
- Horizontal shackle clearance: 22mm.
- Vertical shackle clearance: 56mm.
- Shackle dia: 6.5mm.
- 3 brass keys.

CODE	Description	Unit	4+	1+
PAD038LNG	Long Shackle Padlock	1	6.75	7.50

## Aluminium LED Pocket Torch



- Machined aluminium body with a high power CREE LED light chip.
- Sliding lens for wide angle or focused beam.
- 3 light modes, bright, flashing and energy saving.
- Supplied with an AA battery.
- Length 95mm x 30mm diameter.

CODE	Description	Unit	4+	1+
TOR990LED	LED Torch	1	5.95	6.95

## Brass Padlock



- Brass body and a hardened steel shackle.
- Supplied with 3 keys.
- Excellent value on the 10 rate.

CODE	Size	Unit	10+	4+	1+
TRC25PAD1	25mm	1	4.20	4.60	5.25
TRC32PAD1	32mm	1	4.95	5.25	5.95
TRC38PAD1	38mm	1	5.75	6.25	6.95
TRC50PAD1	50mm	1	10.75	11.75	13.25

## Masterlock Wrought Steel Hasp



- 89mm hard wrought steel hasp.
- Hardened steel padlock eye accepts shackle diameters up to 9mm - Includes fixings.

CODE	Description	Unit	4+	1+
MTL089HSP	Wrought Steel Hasp	1	7.95	8.25

## Hanging Extension Lead



- A height-adjustable power distributor.
- Housing made of break-resistant plastic.
- With double sided, triple socket outlet 240V/13A and a hook for large tools.
- 3 m galvanised steel hanging chain.
- Cable length: 5 m.
- Cable: H05VV-F 3G1.5.

CODE	Description	Unit	4+	1+
BRN635ELH	Extension Lead - Hanging	1	46.95	52.95

## Extension Lead Switched 2m



- Rounded slimline appearance.
- Individually switched shuttered sockets and wall fixing capabilities.
- Length 2m with 4 sockets 13A/240V.

CODE	Description	Unit	2+	1+
ETL234GSW	2m 4 Gang	1	7.75	8.25

## Extension Reel 5m



- Robust cassette reel with rear easy hold grip.
- Thermal cutout protection.
- Length 5m with 4 sockets 10A/240V.

CODE	Description	Unit	2+	1+
CBR051CAS	5m 4 Gang	1	10.25	10.95

## Extension Lead 1m



- Rounded slimline appearance.
- Shuttered sockets and wall fixing capabilities.
- Length 1m with 4 sockets 13A/240V.

CODE	Description	Unit	2+	1+
ETL134GNG	1m 4 Gang	1	3.90	4.20

## Extension Reel 10m



- Robust cassette reel with rear easy hold grip.
- Thermal cutout protection.
- Length 10m with 4 sockets 10A/240V.

CODE	Description	Unit	2+	1+
CBR101CAS	10m 4 Gang	1	14.95	16.25

## Extension Reel 25m



- Industrial open drum style with steel frame.
- Thermal cutout protection.
- Length 25m with 4 sockets 13A/240V.

CODE	Description	Unit	4+	2+	1+
CBR253REL	25m 4 Gang	1	33.50	34.95	37.95

## Extension Lead 3m



- Rounded slimline appearance.
- Shuttered sockets and wall fixing capabilities.
- Length 3m with 6 sockets 13amp/240V.

CODE	Description	Unit	2+	1+
ETL336GNG	3m 6 Gang	1	6.95	7.50

## Extension Lead Surge Protected and USB 2m



- Rounded slimline appearance.
- Surge protected with shuttered sockets and wall fixing capabilities.
- Length 2m with 4 sockets 13A/240V plus 2x USB sockets.

CODE	Description	Unit	2+	1+
ETL234USB	2m USB/Surge Protected	1	14.95	16.25

## Extension Lead Surge Protected 2m



- Rounded slimline appearance.
- Surge protected with shuttered sockets and wall fixing capabilities.
- Length 2m with 4 sockets 13A/240V.

CODE	Description	Unit	2+	1+
ETL234SRP	2m Surge Protected	1	7.75	8.25

## Trailing Lead for 110V 10 Metre



- Robust 10 metre trailing lead, with a hardened plastic plug and socket.
- Cable length 10m x 1.5mm diameter and voltage 110V.

CODE	Description	Unit	4+	1+
TRL110PAS	Trailing Lead	1	34.50	36.95

## Polyethylene Tarpaulin



- Waterproof laminated polyethylene.
- Reinforced hem fitted with eyelets.
- Approximate size 18x12ft poly tarpaulin.

CODE	Description	Unit	4+	1+
TAR1812PY	Tarpaulin	1	13.95	15.75

## Safety Helmet



- A premium vented helmet with a reduced peak.
- High comfort adjustable Terylene headgear and sweatband.

CODE	Description	Unit	50+	10+	1+
HLM200WHT	Safety Helmet	1	5.95	6.25	6.95

## Chukka Safety Boot



- Black leather upper.
- Moisture absorbent comfort lined.
- Steel toe cap and steel midsole.

CODE	UK Sizes	Unit	10+	5+	1+
SKC360BLK	36/3	1	18.95	19.95	21.95
SKC370BLK	37/4	1	18.95	19.95	21.95
SKC380BLK	38/5	1	18.95	19.95	21.95
SKC390BLK	39/6	1	18.95	19.95	21.95
SKC410BLK	41/7	1	18.95	19.95	21.95
SKC420BLK	42/8	1	18.95	19.95	21.95
SKC430BLK	43/9	1	18.95	19.95	21.95
SKC440BLK	44/10	1	18.95	19.95	21.95
SKC460BLK	46/11	1	18.95	19.95	21.95
SKC470BLK	47/12	1	18.95	19.95	21.95
SKC480BLK	48/13	1	18.95	19.95	21.95

## Twin Outlet Transformer 3.3Kva 110V



- For use when using portable electric tools on outdoor sites – transforms 240V to 110V.
- Glass reinforced polyester case with 13 amp plug.
- Completely encapsulated for extra weatherproofing.
- 3.3Kva, 2 x 110V 16 amp sockets.
- Not suitable for use on 110v heaters where a continuous load is required.

CODE	Description	Unit	4+	1+
TRN330TWN	Transformer	1	85.00	89.50

## Traffic Cone Heavy Duty 450 or 750mm



- Robustly constructed traffic cone
- White reflective band

CODE	Size	Unit	6+	2+	1+
TCN450HDT	450mm	1	5.95	6.50	6.95
TCN750HDT	750mm	1	9.95	10.95	11.95

## Distribution Box



- Capable of converting the power from a single cable input into a four way output making it ideal for running multiple power tools and site lighting.
- 5m cable with 110V socket plug.
- Strong metal construction and 4 x 110 volt outlets are protected with flip up plastic covers which also protect the outlets when not in use.

CODE	Description	Unit	4+	1+
DBX114WAY	4 Way Distribution Box	1	65.20	67.50

## No Waiting Cone 500mm



- Robustly constructed cone.
- Yellow, with band showing No Waiting sign.

CODE	Size	Unit	4+	2+	1+
TCN500NWC	500mm	1	8.50	8.95	9.95

## Hi-Vis Vest



- 100% polyester, high visibility vest to EN471 Class 2.

CODE	Size	Unit	50+	10+	1+
HVW471SML	Small	1	2.75	3.10	3.25
HVW471MED	Medium	1	2.75	3.10	3.25
HVW471LRG	Large	1	2.75	3.10	3.25
HVW471EXL	X Large	1	2.75	3.10	3.25



## Laboratory Coats



- Concealed stud front with breast pocket, lower pockets and vented back.
- 65%/35% T-TEC polycotton.

CODE	Size	Colour	Unit	50+	10+	1+
LCW111SML	S	White	1	14.95	15.95	18.75
LCW111MED	M	White	1	14.95	15.95	18.75
LCW111LRG	L	White	1	14.95	15.95	18.75
LCW111EXL	XL	White	1	14.95	15.95	18.75
LCW222SML	S	Navy	1	14.95	15.95	18.75
LCW222MED	M	Navy	1	14.95	15.95	18.75
LCW222LRG	L	Navy	1	14.95	15.95	18.75
LCW222EXL	XL	Navy	1	14.95	15.95	18.75

## Boiler Suit



- Studded flap, breast pocket, rear pocket, rule pocket and access/side pockets.
- Elasticated waist and concealed stud front.
- 65%/35% T-TEC polycotton.

CODE	Size	Colour	Unit	50+	10+	1+
BSU245SML	S	Navy	1	19.50	20.50	22.50
BSU245MED	M	Navy	1	19.50	20.50	22.50
BSU245LRG	L	Navy	1	19.50	20.50	22.50
BSU245EXL	XL	Navy	1	19.50	20.50	22.50

## Navy Cotton Apron



- High quality 100% navy blue coloured cotton.
- Waist tie straps (not elastic) and available with central double pouch or without.
- The youth size has an adjustable neck strap to accommodate a wider range of students - 30" long, not including the neck strap.
- Standard size - 37" long, not including the neck strap.
- 28in at the widest part.

CODE	Size	Style	Unit	50+	10+	1+
COT301APN	28"x 30" L	No Pocket	1	5.75	6.25	6.75
COT302APN	28" x 30"L	With Pocket	1	5.95	6.50	6.95
COT373APN	28" x 37L	No Pocket	1	5.75	6.25	6.75
COT374APN	28" x 37L	With Pocket	1	5.95	6.50	6.95

## Disposable Coveralls



- Lightweight spun polyethylene disposable coverall.
- Elasticated hood, waist, cuffs and ankles.
- Provides barrier protection against dry particulates and water based chemicals.

CODE	Size	Unit	50+	10+	1+
TYK111SML	Coverall Small	1	10.00	10.70	11.25
TYK111MED	Coverall Medium	1	10.00	10.70	11.25
TYK111LRG	Coverall Large	1	10.00	10.70	11.25
TYK111EXL	Coverall X Large	1	10.00	10.70	11.25

## Cotton Apron



- High quality 100% natural coloured cotton.
- Waist tie straps (not elastic) and available with central double pouch or without.
- Standard size - 36" long, not including the neck strap.
- 28in at the widest part.

CODE	Style	Unit	50+	10+	1+
COT36APR1	With Pocket	1	4.95	5.50	5.95
COT36APR2	No Pocket	1	4.75	5.25	5.75

## Leather Apron



- Split suede leather
- Neck loop, front pocket and waist ties

CODE	Description	Unit	2+	1+
KAN200LAP	Leather Apron	1	34.95	37.95

## Oil Spill Kit



- Oil Spill kit contains: 1 bag, 12 pads, 2 socks, 2 disposable bags, ties and instructions.
- Supplied in a resealable storage and carrying case.

CODE	Description	Unit	1+
OSK150KIT	Oil spill kit	1	21.25

## Lightweight Ear Defender



- A lightweight ear defender which affords protection to the majority of wearers from damaging noise levels.
- The ear shells are manufactured from high-impact ABS
- Flexible PVC headband.
- Manufactured to EN 352.1.

CODE	Description	Unit	10+	4+	1+
EDF050LW	Ear Defender	1	4.95	5.75	6.75

## Professional Ear Defender



- High quality professional ear defender with cushion padded head band and comfortable ear cups.
- Provides superior protection for mid range frequency.
- Folds to a compact size for storage.
- Manufactured to EN 352.1.

CODE	Description	Unit	10+	4+	1+
EDF052MID	Prof. Ear Defender	1	8.95	9.95	11.95

## Disposable Foam Ear Plug Pack of 200



- Disposable foam ear plug, tapered and easy-fit.
- Low-pressure ear plug with SNR37 attenuation.

CODE	Description	Unit	10+	4+	1+
EPG200PAK	Ear Plugs	Pack of 200	22.95	23.95	24.95

## Criss Cross Knit Wrist Gloves Pair



- Machine knitted gloves coated with PVC.
- Criss cross pattern - elasticated wrist.
- Ensures firm grip.
- Supplied as a pair.

CODE	Description	Unit	60+	12+	1+
GLV1PRLAT	Knit Wrist Gloves	Pair	1.80	1.95	2.25

## Heat Resistant Grip Gloves



- Soft, breathable and extremely durable NFT® palm coated nylon & lycra blended glove.
- The NFT coating provides level 1 heat resistance (up to 100°C), level 4 abrasion resistance and level 1 tear and cut protection.
- Ideal for handling warm items i.e. heated plastic from a line bender or former.

CODE	Description	Unit	12+	1+
GLV600HGG	No.6/X.Small	1	4.95	5.50
GLV700HGG	No.7/Small	1	4.95	5.50
GLV800HGG	No.8/Medium	1	4.95	5.50
GLV900HGG	No.9/Large	1	4.95	5.50

## Disposable Powder Free Nitrile Gloves Pack of 100



- These popular gloves are tough and resilient to a range of diluted chemical.
- Powder free and latex free.

CODE	Size	Unit	10+	4+	1+
GLV100NSF	Small	Pack of 100	6.95	7.95	8.95
GLV100NMF	Medium	Pack of 100	6.95	7.95	8.95
GLV100NLF	Large	Pack of 100	6.95	7.95	8.95

## Grip Gloves Pair



- A seamless cotton glove with latex coated palm for excellent grip.
- Ideal for handling any rough objects - colours may vary.

CODE	Description	Unit	60+	12+	1+
GLV1PRBLD	Grip Gloves	Pair	1.50	1.95	2.50

## Premium Rigger Gloves Pair



- Superior quality leather with padded palm for protection and insulation.
- Protects against cuts and abrasions.

CODE	Description	Unit	60+	12+	1+
GLV1PRPRE	Premium Rigger	Pair	3.50	3.75	4.50

## Rigger Gloves Pair



- Protects against cuts and abrasions.
- 3/4 chrome leather with Canadian pattern glove.

CODE	Description	Unit	60+	12+	1+
GLV1PRRIG	Rigger Glove	Pair	2.75	2.95	3.25

## Flexible Coated Nylon Glove Pair



- Highly popular with tradesman due to its excellent dexterity and a good level of abrasion resistance.
- Black knitted seamless nylon breathable glove.
- High flexible black polyurethane coating on the palms.

CODE	Description	Unit	60+	12+	1+
GLV1PRBPU	Nylon Glove	1	1.25	1.50	1.95

## Welding Gauntlets Pair



- Premium quality leather lined welding gauntlet, ideal hand protection for welding, brazing and other heat related tasks.
- Tested in accordance with EN388.

CODE	Description	Unit	12+	1+
GLV1PRWEL	Welding Gauntlets	1	10.95	12.50

## Madrid Safety Spectacles



- Popular clear polycarbonate safety eyewear, can be worn over prescription spectacles.
- Vented side arms.
- Conforms to EN166.

CODE	Description	Unit	30+	10+	1+
SEW014MAD	Madrid Spectacle	1	1.25	1.50	1.95

## Junior Goggle



- Direct vent safety goggle made in a smaller size to suit students.
- Soft, flexible vinyl frame Tough polycarbonate lens (120mm wide).
- Conforms to EN166.

CODE	Description	Unit	30+	10+	1+
SEW200JNG	Junior Goggle	1	2.50	2.75	2.95

## Adult Stealth 7000 Safety Spectacles



- Ultra lightweight safety spectacles with a one-piece lens.
- Adult size with a 145mm width.
- Contoured design provides a close comfortable fit and excellent vision.
- Conforms to EN166.

CODE	Description	Unit	30+	10+	1+
SEW700STL	Adult Stealth	1	2.25	2.50	2.75

## Junior Stealth 7000 Safety Spectacles



- Ultra lightweight safety spectacles with a one-piece lens.
- Junior size with a 130mm width.
- Contoured design provides a close comfortable fit and excellent vision.
- Conforms to EN166.

CODE	Description	Unit	30+	10+	1+
SEW166ZSS	Junior Stealth	1	2.25	2.50	2.75

## Safety Goggle



- Industrial safety goggle with a clear lens giving excellent protection.
- Indirect ventilation for additional safety and comfort.
- Can be worn over spectacles.
- Conforms to EN 166.

CODE	Description	Unit	30+	10+	1+
SEW250SGG	Goggle	1	2.50	2.75	2.95

## Kanga Safety Spectacles



- Modern wrap around style with nylon frame and polcarbonate lens.
- Comfortable eyewear due to its light weight and being adjustable.
- Side arms adjust for length and angle.
- Conforms to EN166.

CODE	Description	Unit	30+	10+	1+
KAN601UCI	Kanga Spectacle	1	4.75	5.35	5.50

## Bolle Silium Eye Shields



- Metal framed spectacles with a sleek and attractive design, providing optimal protection and panoramic vision.
- Non-slip tipgrip and bridge with 160 degeree flex sprung arms.
- Contoured design provides a close comfortable fit and excellent vision.
- Conforms to EN166.

CODE	Description	Unit	30+	10+	1+
BOL190SLM	Eye Shields	1	10.95	11.50	11.95

## Safety Eyewear Storage



- Invaluable storage system for safety spectacles, eyeshields and goggles
- 20 gusseted pouches.
- Eyeleted header for attaching to a wall or door.
- Soft non-scratch canvas material.

CODE	Description	Unit	4+	1+
SES020PCK	Safety Eyewear Storage	1	22.50	23.95

PPE

## Browguard and Visor



- Faceshield with a fully adjustable browguard and head harness, fitted with a polycarbonate lens.
- Provides full face protection when woodturning, power carving, spraying and many other activities.
- Conforms to EN166.

### Spare Visor:

- Replacement 200mm/8" polycarbonate visor to suit browguard.
- Conforms to EN166.

CODE	Description	Unit	10+	4+	1+
BRG202SET	Browguard & Visor Set	1	<b>8.95</b>	9.50	10.25
BRG200VSR	Spare Visor	1	<b>6.50</b>	6.75	6.95

## OX Twin Filter Cartridges - P3 Pack of 2



- Pack of 2 P3 replaceable cartridges.
- To suit the OX S450 Half Mask.

CODE	Description	Unit	4+	1+
OXT453CAR	P3 Filters	Pack of 2	<b>15.75</b>	16.95

## Deb Skin Safety Centre



- Pre-assembled, high impact Deb Skin Safety Centre supplied complete with stylish, functional lockable empty dispensers.
- The Deb Skin Safety Centre details a clear 1, 2 and 3 stage program for the protection, cleansing and care of your hands.

CODE	Description	Unit	2+	1+
DEB925CEN	Dispenser Only	1	<b>79.95</b>	82.50

## Auto Welding Helmet Large View



- Slim and lightweight with full face coverage.
- Full neck coverage, locking headgear and automatic power on/off switch.
- The auto on, auto darkening, wide view lens switches from light to dark in 1/25,000th of a second and offers continuous eye protection against UV and IR radiation, even when the lens is in the light state model.
- The welding filter has 4 sensors that react independently as the welding arc is struck enabling the almost instantaneous darkening of the filter.
- The welding helmet has 2 sensors.

CODE	Description	Unit	2+	1+
AWH916AUT	Helmet - Black	1	<b>39.95</b>	45.00

## FFP2 Disposable Dust Mask Pack of 10



- A high quality FFP2V disposable dust mask with exhalation valve for easier breathing.
- For protection against fine toxic dusts, mists, fumes and oil, water based particulates.
- Twin elasticated head straps and compatible with other facial protection equipment.
- Conforms to BS EN149:2001.

CODE	Description	Unit	4+	1+
RES210PAK	FFP2	Pack of 10	<b>11.95</b>	12.95

## OX Pro S450 Half Mask Respirator



- A professional twin cartridge half mask with a unique low resistance exhalation valve for easy breathing.
- Durable thermoplastic rubber mask for superior fit to most face shapes.
- 4 point suspension harness with quick release buckles.
- Conforms to EN140:1998.
- Respirator only - cartridges must be purchased separately.

CODE	Description	Unit	4+	1+
OXT450RES	Respirator only	1	<b>19.50</b>	21.25

## Disposable H E Dust Mask FFP3 Pack of 10



- Comfortable Cup shaped mask with an exhalation valve for lighter breathing resistance.
- Adjustable nose clip for optimized fit.
- All-round internal foam gasket for maximum comfort.
- Wide adjustable elastic bands.
- Conforms to FFP3, CE certified, UKCA marked, CE-CAT III.

CODE	Description	Unit	4+	1+
RES300P10	FFP3	Pack of 10	<b>19.95</b>	22.95

## Deb Protect



- Deb protect 1 litre barrier cream with added protection against oil and water soluble substances.

CODE	Description	Unit	6+	1+
DEB923PRT	Protect - 1 litre	1	<b>24.95</b>	25.75

## Deb Cleanser



- Deb lime 2 litre heavy duty skin cleanser with added granules for removing ingrained grime and dirt.

CODE	Description	Unit	4+	1+
DEB921CLN	Cleanser - 2 Litre	1	<b>16.95</b>	17.50

## Deb Restore



- Deb restore 1 litre skincare lotion to restore skin's natural oils.

CODE	Description	Unit	6+	1+
DEB922RES	Care Lotion - 1 Litre	1	<b>27.95</b>	28.50

## Rigid Plastic Safety Signs



CODE	Size	Unit	1+
15003G	300 x 100mm	1	7.50



CODE	Size	Unit	1+
15203G	300 x 100mm	1	7.50



CODE	Size	Unit	1+
15001G	300 x 100mm	1	7.50



CODE	Size	Unit	1+
15405G	300 x 100mm	1	7.50



CODE	Size	Unit	1+
15021G	300 x 100mm	1	7.50



CODE	Size	Unit	1+
15404G	300 x 100mm	1	7.50



CODE	Size	Unit	1+
15207G	300 x 100mm	1	7.50



CODE	Size	Unit	1+
15447G	300 x 100mm	1	7.50

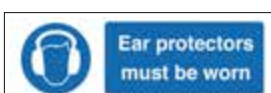

CODE	Size	Unit	1+
15023G	300 x 100mm	1	7.50



CODE	Size	Unit	1+
14210G	300 x 100mm	1	7.50



CODE	Size	Unit	1+
16005E	200 x 150mm	1	11.50



CODE	Size	Unit	1+
16002H	300 x 250mm	1	20.50



CODE	Size	Unit	1+
14016E	200 x 150mm	1	11.50

## Peel 'n' Stick Labels

Supplied in sheets of 6 self adhesive labels.



CODE	Size	Unit	1+
55030	50mm dia.	1 Sheet	15.50



CODE	Size	Unit	1+
55031	50mm dia.	1 Sheet	15.50



CODE	Size	Unit	1+
55032	50mm dia.	1 Sheet	15.50

## First Aid Kit



- Fully stocked and compliant with Health and Safety regulations.
- Packed in a green durable carry case

CODE	Description	Unit	1+
FA0110KIT	1-10 Person First Aid Kit	1	29.95

## Eyewash Station



- Eyewash pod station with mirror, instructions, 8 x 20ml eyewash pods and 2 x eye pad bandages.

CODE	Description	Unit	1+
EYE820STA	Eyewash Station	1	15.95

## Fabric Sterile Plasters Pack 120 Assorted



- 120 assorted fabric adhesive dressings.

CODE	Description	Unit	1+
PLS120FAB	120 Fabric Plasters	1	9.95

## Waterproof Sterile Plasters Pack 120 Assorted



- 120 assorted waterproof adhesive dressings.

CODE	Description	Unit	1+
PLS120WTP	120 Waterproof Plasters	1	9.95

## Heavy Duty Sack Truck



- 150 kg carrying capacity.
- Tubular steel frame construction.
- Pneumatic wheel with steel centre.

CODE	Description	Unit	1+
SKT150HDT	Sack Truck	1	<b>59.95</b>

## Pneumatic Wheels



- 10" diameter pneumatic wheel with a heavy duty steel hub.
- Twin ball races with 16mm / 5/8" bore.
- Rated for 135kg/300lb load per wheel.
- Ideal for use on trucks, trolleys, carts and children's toys.

CODE	Description	Unit	4+	1+
WHL1016PN	Pneumatic Wheels	1	<b>12.50</b>	14.25

## Refill 70% Alcohol Hand Sanitiser Gel 5 Litre



- Bottle of high quality 70% alcohol hand sanitiser gel.
- Easy to use and highly effective.
- COSHH data sheets available.
- Product Testing sheets available.
- Size: 5 Litres.

CODE	Description	Unit	1+
ZZ14803	Refill - 5 Litre	1	<b>15.95</b>

## Pallet Truck 2.5 Ton



- Robust fully hydraulic lifting and lowering.
- Easy to move heavy loads with nylon wheels.
- Fork length 1150mm and a width of 540mm.

CODE	Description	Unit	1+
PLT250NYL	2.5 Ton	1	<b>450.00</b>

## Stopguardz Emergency Stop



- Locking kickstop with a 70mm mushroom button.
- Twist To Release Red Button.
- 2 Normally Closed Contacts.
- Made in Europe to current specifications.

CODE	Description	Unit	4+	1+
SGD070EMS	Emergency Stop	1	<b>44.50</b>	47.75

## Fresh Detox Antibacterial Wet Wipes Pack of 120



- PH balanced antibacterial wet wipes provide a quick and easy solution for hygienic cleaning on both skin and surfaces.
- PH balanced
- Does not contain bleach.
- Soft and moist to be gentle on skin
- Safe for use by children and on food areas.
- Size: 150 x 170mm.

CODE	Description	Unit	54+	18+	1+
ZZ14880	Antibacterial Wipes Pack of 120	<b>3.50</b>	3.95	4.50	

## Electric Powered Pallet Truck 2 Ton



- Easy to operate, powerful and compact 2 ton pallet truck - electric drive and electric lift.
- Reversing button and accelerator controls on handle.
- Portable and removable lithium battery - quick charge 2-5 hours.
- Emergency stops on both the handle and the body.
- Fork dimensions 1150 x 550mm.

CODE	Description	Unit	1+
PLT200ELC	2 Ton	1	<b>POA</b>

## Stopguardz Isolator Switch



- Locking isolator switch.
- 3 Pole 20A.
- Enclosed IP65 rated.
- Compliant for educational use.

CODE	Description	Unit	4+	1+
SGD652SWT	Isolator Switch	1	<b>32.50</b>	34.95

## Cleervue Drill Chuck Guards



- UK made drill guard constructed from moulded polycarbonate.
- Positive manual latch and a flip up with spring retention.
- Telescopes on contact with work piece, length adjustable visor which encloses the work area.
- Secures to the drilling machine collar - 65mm or 75mm (for other sizes, please enquire).

CODE	Size	Unit	1+
CLV065DCG	65mm	1	<b>79.95</b>
CLV075DCG	75mm	1	<b>79.95</b>



# Cutting Tools

---

**Milling & Turning Equipment**  
184-188

---

**Threading, Reaming & Drilling**  
189-195

---

**Saw Blades**  
196-200

---

**Router Cutters**  
200-204



## H.S.S. Milling Cutters

### Slot Drills Standard Metric



CODE	Diameter	Unit	3+	1+
MLC003SST	3mm	1	7.95	8.75
MLC004SST	4mm	1	7.95	8.75
MLC005SST	5mm	1	7.95	8.75
MLC006SST	6mm	1	7.75	8.50
MLC007SST	7mm	1	5.75	6.25
MLC008SST	8mm	1	9.50	10.25
MLC010SST	10mm	1	9.50	10.25
MLC012SST	12mm	1	11.50	12.50
MLC014SST	14mm	1	12.50	
MLC015SST	15mm	1	18.25	
MLC016SST	16mm	1	19.50	
MLC018SST	18mm	1	19.95	
MLC020SST	20mm	1	19.50	
MLC025SST	25mm	1	46.75	

### Slot Drills Long Series Metric



CODE	Diameter	Unit	3+	1+
MLC004SLS	4mm	1	10.50	11.50
MLC005SLS	5mm	1	10.50	11.50
MLC006SLS	6mm	1	10.50	11.50
MLC008SLS	8mm	1	11.50	12.50
MLC010SLS	10mm	1	11.95	12.95
MLC012SLS	12mm	1	11.50	12.50
MLC014SLS	14mm	1	15.50	
MLC016SLS	16mm	1	17.50	

### End Mills Standard Metric



CODE	Diameter	Unit	3+	1+
MLC003EST	3mm	1	7.75	8.50
MLC004EST	4mm	1	7.75	8.50
MLC005EST	5mm	1	7.75	8.50
MLC006EST	6mm	1	7.75	8.50
MLC008EST	8mm	1	7.95	8.75
MLC010EST	10mm	1	7.25	7.95
MLC012EST	12mm	1	12.50	13.50
MLC014EST	14mm	1	14.75	
MLC015EST	15mm	1	17.25	
MLC016EST	16mm	1	17.25	
MLC018EST	18mm	1	19.95	
MLC020EST	20mm	1	19.95	
MLC025EST	25mm	1	36.25	

The shank sizes of the cutters are as follows:

Metric Cutters	Shank
Up to 6mm	6mm
7 - 10mm	10mm
11 - 14mm	12mm
15 - 20mm	16mm
22 - 25mm	25mm

### End Mills Long Series Metric



CODE	Diameter	Unit	3+	1+
MLC003ELS	3mm	1	8.75	9.50
MLC004ELS	4mm	1	8.75	9.50
MLC005ELS	5mm	1	8.75	9.50
MLC006ELS	6mm	1	8.75	9.50
MLC008ELS	8mm	1	7.25	7.95
MLC010ELS	10mm	1	7.95	8.75
MLC012ELS	12mm	1	10.25	11.25
MLC014ELS	14mm	1	19.25	
MLC016ELS	16mm	1	21.50	

### Ball Nosed Slot Drills Standard Metric



CODE	Diameter	Unit	3+	1+
MLC002BNS	2mm	1	16.95	18.50
MLC003BNS	3mm	1	17.75	19.25
MLC004BNS	4mm	1	17.95	19.50
MLC005BNS	5mm	1	17.95	19.50
MLC006BNS	6mm	1	9.75	10.50
MLC008BNS	8mm	1	10.95	11.95
MLC010BNS	10mm	1	16.75	18.25
MLC012BNS	12mm	1	16.75	18.25
MLC016BNS	16mm	1	45.25	
MLC020BNS	20mm	1	50.50	

### Ball Nosed Slot Drills Long Series Metric



CODE	Diameter	Unit	3+	1+
MLC006BNL	6mm	1	22.95	24.95
MLC008BNL	8mm	1	15.50	16.95
MLC010BNL	10mm	1	15.50	16.95
MLC012BNL	12mm	1	21.25	23.25

### Solid Carbide 3-Flute Milling Cutters



- Precision ground milling cutters with plain shanks.
- Manufactured from solid K10 carbide.
- Cutting diameter and shank diameter are the same in each size.

CODE	Dia. x Cutting Length	Unit	5+	1+
SCM030312	3mm x 12mm	1	8.95	9.75
SCM040412	4mm x 12mm	1	12.50	13.50
SCM050514	5mm x 14mm	1	15.50	16.95
SCM060616	6mm x 16mm	1	16.50	17.95
SCM080820	8mm x 20mm	1	18.50	20.25
SCM101022	10mm x 22mm	1	34.50	37.50

## Borman HSS Small Milling Cutters



- Small precision milling cutters with a parallel shank.
- Manufactured from 5% cobalt HSS for long life.
- Ideal for CNC routers and mills.

### Metric - Standard Length (6mm shank) Borman

CODE	Diameter	Unit	5+	1+
TMC105MSD	1.5mm	1	3.90	4.30
TMC002MSD	2mm	1	3.90	4.30
TMC205MSD	2.5mm	1	3.90	4.30
TMC003MSD	3mm	1	3.90	4.30
TMC305MSD	3.5mm	1	3.90	4.30
TMC004MSD	4mm	1	3.90	4.30
TMC005MSD	5mm	1	3.90	4.30
TMC006MSD	6mm	1	3.90	4.30



### Metric - Long Length (6mm shank) Borman

CODE	Diameter	Unit	5+	1+
TMC105MLS	1.5mm	1	6.75	7.25
TMC002MLS	2mm	1	6.75	7.25
TMC205MLS	2.5mm	1	6.75	7.25
TMC003MLS	3mm	1	6.75	7.25
TMC305MLS	3.5mm	1	6.75	7.25
TMC004MLS	4mm	1	6.75	7.25
TMC005MLS	5mm	1	6.75	7.25
TMC006MLS	6mm	1	6.75	7.25

## HSS Small Ball Nose Cutters



### Ball Nosed - Standard Length (6mm shank)

CODE	Dia. x Cutting Length	Unit	5+	1+
TMC002MBN	2mm x 6mm	1	5.50	5.95
TMC003MBN	3mm x 6mm	1	5.50	5.95
TMC004MBN	4mm x 6mm	1	5.50	5.95
TMC005MBN	5mm x 6mm	1	5.50	5.95
TMC006MBN	6mm x 6mm	1	5.50	5.95



## Turntech 3 Jaw Chuck



- Self-centering 3 jaw chuck, supplied with inside and outside hard jaws and key.
- Plain recessed back allows mounting to a backplate or fixture.

CODE	Diameter	Unit	1+
TTH1003JW	4"/100mm	1	<b>101.25</b>
TTH1253JW	5"/125mm	1	<b>123.25</b>
TTH1603JW	6 1/4"/160mm	1	<b>179.50</b>
TTH2003JW	8"/200mm	1	<b>258.25</b>

## Morse Taper Sleeves



- Converts machine spindles to smaller taper.
- Case hardened and ground.

CODE	Outside Taper	Bore	Unit	1+
MTS2MT1MT	2MT	1MT	1	<b>7.75</b>
MTS3MT1MT	3MT	1MT	1	<b>9.00</b>
MTS3MT2MT	3MT	2MT	1	<b>9.00</b>
MTS4MT1MT	4MT	1MT	1	<b>13.00</b>
MTS4MT2MT	4MT	2MT	1	<b>13.00</b>
MTS4MT3MT	4MT	3MT	1	<b>13.00</b>

## Borman H.S.S Square Toolbits



- Ground high speed steel.

CODE	Size	Unit	10+	5+	1+
BOR516305	5/16" x 3"	1	<b>5.00</b>	5.25	5.50
BOR380405	3/8" x 4"	1	<b>6.75</b>	7.25	7.75
BOR120405	1/2" x 4"	1	<b>8.75</b>	9.00	9.50

## Borman ER 32 Collets



- Individual collets for the Borman ER 32 collet chucks.
- The design of the collet creates a powerful parallel gripping force for precise concentricity.

CODE	Size	Unit	1+
BOR030232	3 - 2mm	1	<b>21.25</b>
BOR040332	4 - 3mm	1	<b>21.25</b>
BOR050432	5 - 4mm	1	<b>21.25</b>
BOR060532	6 - 5mm	1	<b>21.25</b>
BOR070632	7 - 6mm	1	<b>21.25</b>
BOR080732	8 - 7mm	1	<b>21.25</b>
BOR090832	9 - 8mm	1	<b>21.25</b>
BOR100932	10 - 9mm	1	<b>21.25</b>
BOR111032	11 - 10mm	1	<b>21.25</b>
BOR121132	12 - 11mm	1	<b>21.25</b>
BOR131232	13 - 12mm	1	<b>21.25</b>
BOR141332	14 - 13mm	1	<b>21.25</b>
BOR151432	15 - 14mm	1	<b>21.25</b>
BOR161532	16 - 15mm	1	<b>21.25</b>
BOR171632	17 - 16mm	1	<b>21.25</b>
BOR181732	18 - 17mm	1	<b>21.25</b>
BOR191832	19 - 18mm	1	<b>21.25</b>
BOR201932	20 - 19mm	1	<b>21.25</b>

## Borman ER 32 Collet Chucks



- These collet chucks will accept any straight or screwed shank cutters within their range.
- Chucks and collets are sold separately, so only the collets immediately required need to be purchased.
- Operating spanner for the chuck nut is required and is available separately.

CODE	Chuck	Shank	Size	Unit	1+
BORER323T	ER32	3MT	M12	1	<b>89.50</b>
BORER32R8	ER32	R8	7/16 UNF	1	<b>89.50</b>
BORER3230	ER32	30 ISO	M12	1	<b>89.50</b>
BORER3240	ER32	40 ISO	M16	1	<b>112.00</b>

## Borman Operating Spanner



- Operating spanner for collet chuck nut.

CODE	To Suit	Unit	1+
BOR32SPAN	ER32 chuck	1	<b>29.25</b>

## Borman Revolving Centres



- Well finished live centres, hardened and ground.
- Multiple bearings for durability and smooth running.

CODE	Description	Unit	2+	1+
BOR1MTRVC	1MT	1	<b>30.25</b>	36.00
BOR2MTRVC	2MT	1	<b>33.75</b>	40.50
BOR3MTRVC	3MT	1	<b>45.00</b>	51.75

## Extractor Drifts



- For knocking out the morse taper from a machine spindle.

CODE	No.	For MT	Unit	1+
GRO1MTEXD	1	0 and 1	1	<b>4.50</b>
GRO2MTEXD	2	1 and 2	1	<b>5.00</b>
GRO3MTEXD	3	3	1	<b>6.00</b>

### SEE WORKPLACE EQUIPMENT

## NOW STOCKING Cleervue Drill Guards

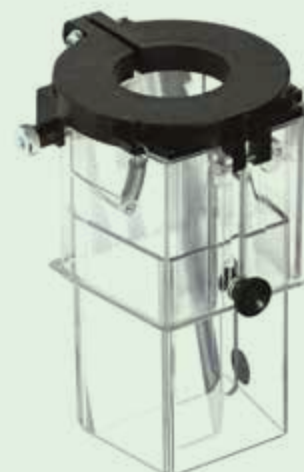

## Turntech Quick Change Toolpost Set 00 Size



TTH00QCST



TTH001SHD

TTH002VHD

TTH003PHD

- The Turntech system is interchangeable with other similar quick-change toolposts and is available as a complete set or individual holders.
- The No.00 size suits lathes with a centre height in the region of 3½".
- Complete set comprises of 1 toolblock, a wrench, 2 standard holders, a vee holder and a parting holder with a blade.
- The dimension from the top slide to the centre is ¾" - 1⅛".
- The tool shank capacity is ½" and the parting blade size is ½".

CODE	Description	Unit	1+
TTH00QCST	Complete Set	1	<b>190.75</b>
TTH001SHD	Standard Holder	1	<b>40.50</b>
TTH002VHD	Vee Holder	1	<b>31.50</b>
TTH003PHD	Parting Holder	1	<b>41.50</b>

## Turntech Quick Change Toolpost Set S0 Size



TTHS0QCST



TTHS01SHD

TTHS02VHD

TTHS03PHD

- The Turntech system is interchangeable with other similar quick-change toolposts and is available as a complete set or individual holders.
- The No.S0 size suits lathes with a centre height in the region of 4½".
- Complete set comprises of 1 toolblock, a wrench, 2 standard holders, a vee holder and a parting holder with a blade.
- The dimension from the top slide to the centre is 1¾" - 1⅞".
- The tool shank capacity is ⅝" and the parting blade size is ¾".

CODE	Description	Unit	1+
TTHS0QCST	Complete Set	1	<b>242.00</b>
TTHS01SHD	Standard Holder	1	<b>32.50</b>
TTHS02VHD	Vee Holder	1	<b>39.25</b>
TTHS03PHD	Parting Holder	1	<b>33.75</b>

## Turntech Quick Change Toolpost Set S2 Size



TTHS2QCST



TTHS21SHD

TTHS22VHD

- The Turntech system is interchangeable with other similar quick-change toolposts and is available as a complete set or individual holders.
- The No.S2 size suits lathes with a centre height in the region of 5" to 8".
- The complete set comprises of 1 toolblock, a wrench, 3 standard holders, and a vee holder.
- The dimension from the top slide to the centre is 1⅞" - 2⅝".
- The tool shank capacity is 20mm.

CODE	Description	Unit	1+
TTHS2QCST	Complete Set	1	<b>335.00</b>
TTHS21SHD	Standard Holder	1	<b>54.00</b>
TTHS22VHD	Vee Holder	1	<b>52.75</b>

## Parting Tool Holder



- Parting tool holders have hardened bodies and take standard sized blades.
- Supplied with a wrench and parting blade.

CODE	Blade	Shank Height	Unit	1+
PTHD0S516	⅝"	⅝"	1	<b>18.75</b>
PTHD1S120	½"	¾"	1	<b>25.75</b>
PTHD2S580	⅝"	7⁄8"	1	<b>31.50</b>

## Borman H.S.S. Steel Parting Blades



- Ground high speed steel.
- Sizes given are width / thickness / length.

CODE	Size	Unit	5+	1+
BOR516PTB	⅝" / ⅜" / 3½"	1	<b>10.50</b>	11.25
BOR120PTB	½" / ⅜" / 4½"	1	<b>11.75</b>	12.75
BOR580PTB	⅝" / ⅜" / 5"	1	<b>19.00</b>	20.75
BOR340PTB	¾" / ⅜" / 6"	1	<b>22.25</b>	25.25

## Mini Parting Tool and Blade



- Ideal for the smaller engineering lathe with a shank size of 8mm.
- Complete with an HSS blade 5 x 1.5 x 63mm.

CODE	Description	Unit	1+
PTT805SET	Mini Parting Tool Holder	1	<b>14.50</b>

## Glanze Turning Tool Square Shank

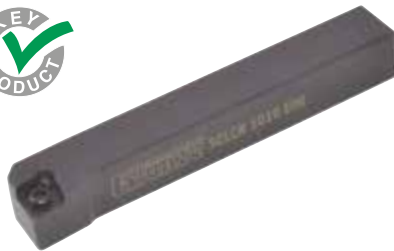

- A high quality range of indexable turning tools, featuring heat treated and accurately machined pockets for perfect tip fitment.
- Fully hardened for durability and with Swiss made clamping screws for long life.
- Indexable tips are sold separately and the same tip fits both the turning and boring tool ranges.

CODE	Square Shank	Unit	1+
GLZ106TTL	10mm	1	<b>32.50</b>
GLZ126TTL	12mm	1	<b>33.75</b>
GLZ166TTL	16mm	1	<b>45.00</b>

## Glanze Boring Bar



- A high quality range of indexable boring bars, featuring heat treated and accurately machined pockets for perfect tip fitment.
- Fully hardened for durability and with Swiss made clamping screws for long life.
- Indexable tips are sold separately and the same tip fits both the turning and boring tool ranges.

CODE	Shank Diameter	Unit	1+
GLZ066BBR	6mm x 80mm	1	<b>33.50</b>
GLZ086BBR	8mm x 100mm	1	<b>40.50</b>
GLZ106BBR	10mm x 125mm	1	<b>42.75</b>
GLZ126BBR	12mm x 150mm	1	<b>45.00</b>

## Glanze Coated Tip For all Boring and Turning Tools



- Indexable tips to suit both the turning and boring tool ranges, 2 mm tip.
- Manufactured from tungsten carbide with a hard coated finish.

CODE	Description	Unit	10+	1+
GLZ204CMT	Coated Tips	1	<b>6.75</b>	7.25

## Torx Screw For Glanze Tools



- Replacement torx screw for both the turning and boring tools.
- Swiss made clamping screws fully hardened for durability and long life.

CODE	Description	Unit	10+	1+
TRX250SCR	Screws	1	<b>3.25</b>	4.00

## Knurling Tool Caliper Type



- Caliper type 2 wheel knurler which accommodates metal bar from 5 - 20mm.
- The side mounted  $\frac{3}{8}$ " clamping block will fit most small lathes.
- Shank height:  $\frac{3}{8}$ ".
- Knurl diameter:  $\frac{3}{4}$ ".

CODE	Description	Unit	1+
KT0223438	Caliper Type	1	<b>31.50</b>

## Glanze Indexable Parting Tool



- A high quality range of indexable parting tools, featuring heat treated and accurately machined pockets for perfect tip fitment.
- The blade which holds the tip can be moved to change the depth of cut.
- An indexable tip is included and the same tip fits the range of parting tools.

CODE	Square Shank	Unit	1+
GLZ10PTBL	10mm	1	<b>74.25</b>
GLZ12PTBL	12mm	1	<b>78.75</b>
GLZ16PTBL	16mm	1	<b>85.50</b>

## Glanze Coated Tip For all Parting Tools



- Indexable tips to suit all the parting tools - 2mm wide tip.
- Manufactured from tungsten carbide with a hard coated finish.

CODE	Size	Unit	10+	1+
GLZ002CTP	2mm	1	<b>9.00</b>	9.50

## Spare Blade for Glanze Parting Tool



- Replacement blade for the parting tool, takes carbide tip GLZ002CTP (no tip supplied).
- Fits all Glanze parting tools.

CODE	Description	Unit	1+
GLZ126SBL	Spare Blade	1	<b>33.75</b>

## Knurling Tool Twin Wheel



- For holding a straight knurl or a pair of helical knurls to produce a diamond pattern.
- The twin wheel knurling tool has a pivoted floating head which self-adjusts to the work.
- Shank height:  $\frac{1}{2}$ ".
- Knurl diameter:  $\frac{3}{4}$ ".

CODE	Description	Unit	1+
KT2523412	Twin Wheel Type	1	<b>16.25</b>

## Spare Knurling Wheels

- All knurling wheels are  $\frac{3}{4}$ " diameter x  $\frac{3}{8}$ " wide x  $\frac{1}{4}$ " bore.



### Straight

CODE	Size	Unit	1+
K34STRAT2	Medium	1	<b>5.00</b>

- All knurling wheels are  $\frac{3}{4}$ " diameter x  $\frac{3}{8}$ " wide x  $\frac{1}{4}$ " bore.



### Helical Pair

CODE	Description	Unit	1+
K34HELIC2	Pair of Medium	1	<b>10.00</b>

## Lynx Carbide Insert Lathe Tool Sets 5 Piece

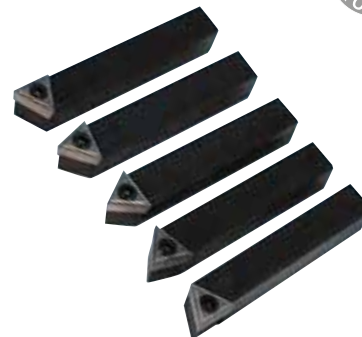

- Contents of set includes straight and two different angles of right and left hand cranked.
- Triangular tips with three cutting points can be renewed in seconds.

### $\frac{1}{2}$ " Shank Square

CODE	Description	Unit	10+	1+
LYX120TIP	$\frac{1}{2}$ " Spare Tip	1	<b>6.75</b>	7.25
LYX1205PC	$\frac{1}{2}$ " Set	5 Piece	<b>51.75</b>	

## Carbide Tipped Lathe Tools



- Brazed tip carbide lathe tools, ISO6 for turning and facing.
- General purpose grade for steels and non-ferrous.

### Turning & Facing ISO 6

CODE	Size	Unit	4+	1+
CLT106P20	10mm	1	<b>8.50</b>	9.25
CLT126P20	12mm	1	<b>9.00</b>	9.50
CLT166P20	16mm	1	<b>12.75</b>	14.00



- Brazed tip carbide lathe tools, ISO9 for boring and facing.
- General purpose grade for steels and non-ferrous.

### Boring & Facing ISO 9

CODE	Size H x L	Unit	4+	1+
CLT109P20	10mm x 150mm	1	<b>11.25</b>	11.75
CLT129P20	12mm x 180mm	1	<b>11.75</b>	13.00
CLT169P20	16mm x 180mm	1	<b>17.25</b>	19.00

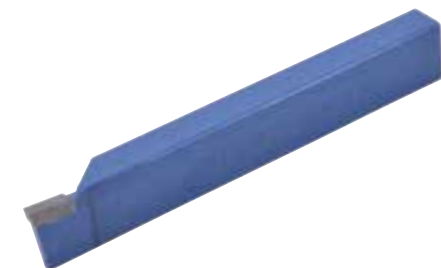

- Brazed tip carbide lathe tools, ISO7 for parting.
- General purpose grade for steels and non-ferrous.

### Parting ISO 7

CODE	Size H x L	Unit	4+	1+
CLT127P20	12mm x 3mm	1	<b>10.50</b>	11.25
CLT167P20	16mm x 3mm	1	<b>15.00</b>	16.25

## Turntech Carbide Tipped Lathe Tool Set 6 Piece



TTH386TCT



TTH126TCT

- Brazed tip carbide lathe tool set with a selection of styles covering most aspects of metal turning.
- General purpose grade for steels and non-ferrous.

CODE	Size	Unit	3+	1+
TTH386TCT	3/8" (10mm) Set	6 Piece	<b>29.00</b>	33.50
TTH126TCT	1/2" (12mm) Set	6 Piece	<b>37.00</b>	41.50

## Turntech Carbide Tipped Lathe Tool Set 11 Piece

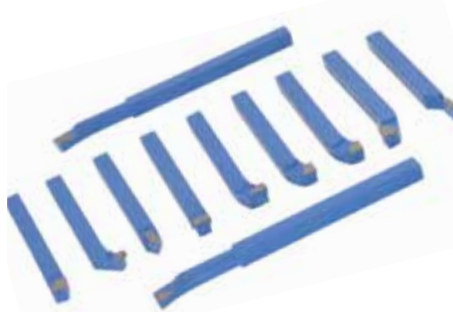

- Brazed tip carbide lathe tool set with a selection of styles covering most aspects of metal turning.
- General purpose grade for steels and non-ferrous.

CODE	Size	Unit	3+	1+
TTH811TCT	8mm Set	11 Piece	<b>41.00</b>	44.50

## Straight Shank Machine H.S.S. Reamers



CODE	Diameter	Unit	1+
REA0003SM	3mm	1	<b>24.50</b>
REA0004SM	4mm	1	<b>20.25</b>
REA0005SM	5mm	1	<b>22.00</b>
REA0006SM	6mm	1	<b>27.25</b>
REA0008SM	8mm	1	<b>31.00</b>
REA0010SM	10mm	1	<b>33.50</b>
REA0012SM	12mm	1	<b>38.75</b>

## Straight Shank Hand H.S.S. Reamers



CODE	Diameter	Unit	1+
REA0002SH	2mm	1	<b>29.75</b>
REA0003SH	3mm	1	<b>23.00</b>
REA0004SH	4mm	1	<b>20.25</b>
REA0005SH	5mm	1	<b>20.25</b>
REA0006SH	6mm	1	<b>22.00</b>
REA0007SH	7mm	1	<b>24.50</b>
REA0008SH	8mm	1	<b>25.50</b>
REA0009SH	9mm	1	<b>31.00</b>
REA0010SH	10mm	1	<b>31.00</b>
REA0011SH	11mm	1	<b>36.00</b>
REA0012SH	12mm	1	<b>33.50</b>
REA0014SH	14mm	1	<b>42.50</b>
REA0015SH	15mm	1	<b>50.00</b>
REA0016SH	16mm	1	<b>47.50</b>
REA0018SH	18mm	1	<b>54.25</b>
REA0020SH	20mm	1	<b>62.25</b>
REA0022SH	22mm	1	<b>80.25</b>
REA0024SH	24mm	1	<b>99.25</b>
REA0025SH	25mm	1	<b>112.50</b>

## Expanding Hand H.S.S. Reamers



- Adjustable reamers having HSS blades. Ideal for obtaining intermediate or oversize diameters in imperial and metric.
- Straight shank with square drive.

CODE	Diameter (mm/inches)	Unit	1+
EHR650700	6.50 - 7.00	1	<b>20.25</b>
EHR700775	7.00 - 7.75	1	<b>21.25</b>
EHR775850	7.75 - 8.50	1	<b>22.50</b>
EHR850925	8.50 - 9.25	1	<b>23.50</b>
EHR925100	9.25 - 10.00	1	<b>24.75</b>
EHR100107	10.00 - 10.75/(0.393 - 0.423)	1	<b>25.00</b>
EHR107117	10.75 - 11.75/(0.423 - 0.462)	1	<b>25.00</b>
EHR117127	11.75 - 12.75/(0.462 - 0.502)	1	<b>25.00</b>
EHR127137	12.75 - 13.75/(0.502 - 0.541)	1	<b>25.00</b>
EHR137152	13.75 - 15.25/(0.541 - 0.600)	1	<b>25.00</b>
EHR152170	15.25 - 17.00/(0.600 - 0.669)	1	<b>25.00</b>
EHR170190	17.00 - 19.00/(0.669 - 0.748)	1	<b>26.50</b>
EHR210230	21.00 - 23.00/(0.826 - 0.905)	1	<b>28.50</b>
EHR230260	23.00 - 26.00/(0.905 - 1.023)	1	<b>31.25</b>
EHR260295	26.00 - 29.50/(1.023 - 1.161)	1	<b>31.25</b>
EHR295335	29.50 - 33.50/(1.161 - 1.318)	1	<b>36.75</b>

## H.S.S. Ground Thread Hand Taps Set of 3



- High Speed Steel Taps supplied in the popular metric sizes.
- Ground thread form for accuracy.
- Set of three leads - taper, second and bottoming.

### Set of 3 Taps

CODE	Diameter (mm)	Unit	4+	1+
TPS003SET	M3 x 0.5	Set of 3	9.25	10.00
TPS004SET	M4 x 0.7	Set of 3	10.75	11.25
TPS005SET	M5 x 0.8	Set of 3	11.25	11.75
TPS006SET	M6 x 1.0	Set of 3	11.75	12.25
TPS008SET	M8 x 1.25	Set of 3	16.50	17.50
TPS010SET	M10 x 1.5	Set of 3	17.75	18.75
TPS012SET	M12 x 1.75	Set of 3	23.50	25.25

## H.S.S. Ground Thread Hand Taps Individual



- Hand Taps have straight flutes and are the most commonly used tap.
- Available in three chamfer leads: Taper (TP1), Second (TP2) and Bottom (TP3).

### Metric Coarse (ISO) Hand - Taper (TP1)

CODE	Diameter (mm)	Unit	1+
TP1002MET	M2 x 0.4	1	11.00
TP1205MET	M2.5x 0.45	1	9.00
TP1003MET	M3 x 0.5	1	4.25
TP1305MET	M3.5 x 0.6	1	6.50
TP1004MET	M4 x 0.7	1	4.50
TP1005MET	M5 x 0.8	1	4.75
TP1006MET	M6 x 1	1	4.75
TP1008MET	M8 x 1.25	1	6.50
TP1010MET	M10 x 1.5	1	7.00
TP1012MET	M12 x 1.75	1	9.25
TP1014MET	M14 x 2	1	13.75
TP1016MET	M16 x 2	1	16.75
TP1018MET	M18 x 2.5	1	25.75
TP1020MET	M20 x 2.5	1	28.00

### Metric Coarse (ISO) Hand - Second (TP2)

CODE	Diameter (mm)	Unit	1+
TP2002MET	M2 x 0.4	1	11.00
TP2205MET	M2.5x 0.45	1	9.00
TP2003MET	M3 x 0.5	1	4.25
TP2305MET	M3.5 x 0.6	1	6.50
TP2004MET	M4 x 0.7	1	4.50
TP2005MET	M5 x 0.8	1	4.75
TP2006MET	M6 x 1	1	4.75
TP2008MET	M8 x 1.25	1	6.50
TP2010MET	M10 x 1.5	1	7.00
TP2012MET	M12 x 1.75	1	9.25
TP2014MET	M14 x 2	1	13.75
TP2016MET	M16 x 2	1	16.75
TP2018MET	M18 x 2.5	1	25.75
TP2020MET	M20 x 2.5	1	28.00

### Metric Coarse (ISO) Hand - Bottom (TP3)

CODE	Diameter (mm)	Unit	1+
TP3002MET	M2 x 0.4	1	11.00
TP3205MET	M2.5x 0.45	1	9.00
TP3003MET	M3 x 0.5	1	4.25
TP3305MET	M3.5 x 0.6	1	6.50
TP3004MET	M4 x 0.7	1	4.50
TP3005MET	M5 x 0.8	1	4.75
TP3006MET	M6 x 1	1	4.75
TP3008MET	M8 x 1.25	1	6.50
TP3010MET	M10 x 1.5	1	7.00
TP3012MET	M12 x 1.75	1	9.25
TP3014MET	M14 x 2	1	13.75
TP3016MET	M16 x 2	1	16.75
TP3018MET	M18 x 2.5	1	25.75
TP3020MET	M20 x 2.5	1	28.00

## H.S.S. Spiral Point and Flute Taps



- Spiral Point Taps have an angled flute at the tip and are used for machine tapping or through holes as the swarf is forced ahead of the tap.



- Spiral Flute Taps are suitable for blind holes as the swarf is drawn up the flutes.

### Metric Coarse (ISO) Spiral Point

CODE	Diameter (mm)	Unit	1+
TPP002MET	M2 x 0.4	1	15.75
TPP003MET	M3 x 0.5	1	8.50
TPP004MET	M4 x 0.7	1	7.50
TPP005MET	M5 x 0.8	1	8.25
TPP006MET	M6 x 1	1	8.50
TPP008MET	M8 x 1.25	1	9.50
TPP010MET	M10 x 1.5	1	11.75
TPP012MET	M12 x 1.75	1	16.50
TPP016MET	M16 x 2	1	24.75
TPP020MET	M20 x 2.5	1	40.50

### Metric Coarse (ISO) Spiral Flute

CODE	Diameter (mm)	Unit	1+
TPF005MET	M5 x 0.8	1	9.75
TPF006MET	M6 x 1	1	10.50
TPF008MET	M8 x 1.25	1	11.50
TPF010MET	M10 x 1.5	1	15.00
TPF012MET	M12 x 1.75	1	21.00
TPF016MET	M16 x 2	1	31.25
TPF020MET	M20 x 2.5	1	52.00

## Metric Fine Hand Taps

### Metric Fine (ISO) Hand - Taper (TP1)

CODE	Diameter (mm)	Unit	1+
TP103035F	3 x 0.35	1	12.75
TP104050F	4 x 0.5	1	12.75
TP105050F	5 x 0.5	1	12.75
TP106075F	6 x 0.75	1	10.00
TP108100F	8 x 1	1	11.50
TP110100F	10 x 1 <sup>†</sup>	1	15.00
TP110125F	10 x 1.25	1	15.00
TP112100F	12 x 1	1	31.25
TP112125F	12 x 1.25 <sup>†</sup>	1	19.50
TP112150F	12 x 1.5	1	19.50
TP114125F	14 x 1.25 <sup>†</sup>	1	26.50
TP114150F	14 x 1.5	1	21.25
TP116150F	16 x 1.5 <sup>*</sup>	1	24.25
TP118150F	18 x 1.5	1	33.50
TP120150F	20 x 1.5 <sup>*</sup>	1	40.50

### Metric Fine (ISO) Hand - Second (TP2)

CODE	Diameter (mm)	Unit	1+
TP203035F	3 x 0.35	1	12.75
TP204050F	4 x 0.5	1	12.75
TP205050F	5 x 0.5	1	12.75
TP206075F	6 x 0.75	1	10.00
TP208100F	8 x 1	1	11.50
TP210100F	10 x 1 <sup>†</sup>	1	15.00
TP210125F	10 x 1.25	1	15.00
TP212100F	12 x 1	1	31.25
TP212125F	12 x 1.25 <sup>†</sup>	1	19.50
TP212150F	12 x 1.5	1	19.50
TP214125F	14 x 1.25 <sup>†</sup>	1	26.50
TP214150F	14 x 1.5	1	21.25
TP216150F	16 x 1.5 <sup>*</sup>	1	24.25
TP218150F	18 x 1.5	1	33.50
TP220150F	20 x 1.5 <sup>*</sup>	1	40.50

### Metric Fine (ISO) Hand - Bottom (TP3)

CODE	Diameter (mm)	Unit	1+
TP303035F	3 x 0.35	1	12.75
TP304050F	4 x 0.5	1	12.75
TP305050F	5 x 0.5	1	12.75
TP306075F	6 x 0.75	1	10.00
TP308100F	8 x 1	1	11.50
TP310100F	10 x 1 <sup>†</sup>	1	15.00
TP310125F	10 x 1.25	1	15.00
TP312100F	12 x 1	1	31.25
TP312125F	12 x 1.25 <sup>†</sup>	1	19.50
TP312150F	12 x 1.5	1	19.50
TP314125F	14 x 1.25 <sup>†</sup>	1	26.50
TP314150F	14 x 1.5	1	21.25
TP316150F	16 x 1.5 <sup>*</sup>	1	24.25
TP318150F	18 x 1.5	1	33.50
TP320150F	20 x 1.5 <sup>*</sup>	1	40.50

## H.S.S. Button Dies



- Circular split dies to fit various sized die stocks as indicated by the outside diameter (O/D).

### Metric Coarse

CODE	Size	O/Dia	Unit	1+
DIE02040M	M2 x 0.4	13/16"	1	<b>29.00</b>
DIE02545M	M2.5x 0.45	13/16"	1	<b>29.00</b>
DIE03050M	M3 x 0.5	13/16"	1	<b>16.25</b>
DIE03560M	M3.5 x 0.6	13/16"	1	<b>21.00</b>
DIE04070M	M4 x 0.7	13/16"	1	<b>7.00</b>
DIE05080M	M5 x 0.8	13/16"	1	<b>8.25</b>
DIE06100M	M6 x 1	13/16"	1	<b>9.25</b>
DIE08125M	M8 x 1.25	1"	1	<b>11.75</b>
DIE10150M	M10 x 1.5	1"	1	<b>15.25</b>
DIE12175M	M12 x 1.75	1"	1	<b>17.75</b>
DIE14200M	M14 x 2	1 5/16"	1	<b>36.00</b>
DIE16200M	M16 x 2	1 1/2"	1	<b>34.25</b>
DIE18250M	M18 x 2.5	1 1/2"	1	<b>44.50</b>
DIE20250M	M20 x 2.5	1 1/2"	1	<b>44.50</b>

### Metric Fine

CODE	Size	O/Dia	Unit	1+
DIE03035F	3 x 0.35	13/16"	1	<b>34.75</b>
DIE04050F	4 x 0.5	13/16"	1	<b>22.50</b>
DIE05050F	5 x 0.5	13/16"	1	<b>22.50</b>
DIE06075F	6 x 0.75	13/16"	1	<b>22.50</b>
DIE08100F	8 x 1	1"	1	<b>27.75</b>
DIE10100F	10 x 1	1"	1	<b>27.75</b>
DIE10125F	10 x 1.25	1"	1	<b>27.75</b>
DIE12100F	12 x 1	1 1/16"	1	<b>40.00</b>
DIE12125F	12 x 1.25	1 5/16"	1	<b>40.00</b>
DIE12150F	12 x 1.5	1 1/16"	1	<b>40.00</b>
DIE14125F	14 x 1.25	1 5/16"	1	<b>40.00</b>
DIE14150F	14 x 1.5	1 5/16"	1	<b>40.00</b>
DIE16150F	16 x 1.5	1 1/2"	1	<b>40.00</b>
DIE18150F	18 x 1.5	1 1/2"	1	<b>45.00</b>
DIE20150F	20 x 1.5	2"	1	<b>45.00</b>

## Die Stocks



- Steel and iron construction (not die cast).

CODE	Size	Unit	4+	1+
DST1316SL	13/16"	1	<b>4.75</b>	6.00
DST1000SL	1"	1	<b>6.00</b>	7.25
DST1516SL	1 5/16"	1	<b>7.25</b>	9.00
DST1120SL	1 1/2"	1	<b>9.75</b>	11.75
DST2000SL	2"	1	<b>15.00</b>	16.25

## T-Handle Tap Wrench



- T-handle type with tap holding collet.
- Collet jaws to hold wide range of taps.
- All steel construction.

CODE	Capacity	Unit	2+	1+
TWR205THD	M2 - M5	1	<b>7.25</b>	8.50
TWR612THD	M6 - M12*	1	<b>10.75</b>	12.25

\* Not including M10

## Steel Tap Wrench

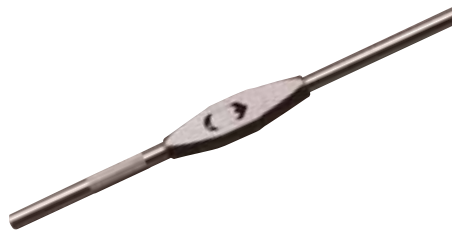

- High quality all steel tap wrench.

CODE	Capacity	Unit	4+	1+
TPW1M0309	M3 - M9	1	<b>9.75</b>	11.75
TPW2M3514	M3.5 - M14	1	<b>15.00</b>	16.00
TPW3M0727	M7 - M27	1	<b>18.50</b>	20.25

## Large Metric Tap & Die Set



- Comprehensive 45 piece set made from tungsten steel and heat treated to Rockwell 58-61C.
- Contents: M6, M8, M10, M12, M14, M16, M18, M20, M22, M24 in both coarse and fine pitches.
- Tap wrench and die stock included.

CODE	Description	Unit	1+
MTD045SET	Metric Tap & Die Set	45 Piece	<b>89.50</b>

## Kaliber H.S.S. Tap & Die Set



- A complete set of HSS taps and solid dies in sizes M3, M4, M5, M6, M8, M10 and M12.
- Three taps for each size - taper, second and plug.
- Made from high speed steel (HSS).
- In a metal box including tap wrench, diestock and screw pitch gauge.

CODE	Description	Unit	1+
KAL032TDS	Tap & Die Set	32 Piece	<b>85.50</b>

## Multi-Size Sliding Dieholder



- Dieholder is for use in lathe tailstocks and has a reversible head to hold 4 sizes of button dies - 3/16", 1", 1 5/16" and 1 1/2".
- Holder slides along the shank as the thread cutting proceeds.
- Maximum thread length of 2".
- Hardened and ground 2MT shank.
- Dies accurately aligned for concentric threads.

CODE	Description	Unit	1+
MSD3202MT	Sliding Dieholder	1	<b>47.25</b>

## H.S.S. Tapping Drill Set



- A set of the correct sized tapping drills to suit the threads M3-M12.

CODE	Description	Unit	1+
KAL007TDS	Tapping Drill Set	7 Piece	<b>9.00</b>

## Drill Chuck Arbors



- Hardened and ground drill chuck arbors.
- All with Jacobs Taper 6 (JT6) to suit drill chucks.

CODE	Shank	Stub	Unit	1+
DCA1MTJT6	1MT	JT6	1	<b>6.75</b>
DCA2MTJT6	2MT	JT6	1	<b>7.25</b>
DCA3MTJT6	3MT	JT6	1	<b>9.50</b>
DCABR8JT6	R8	JT6	1	<b>20.25</b>

## Borman H.S.S. Centre Drills



- For drilling the ends of components to enable them to be held between centres.
- HSS with included angle of 60°.

### Borman - Metric

CODE	Body x Pilot Diameter	Unit	10+	1+
BOR3CTD01	3.15mm x 1.0mm	1	<b>5.50</b>	5.75
BOR4CTD01	4.0mm x 1.6mm	1	<b>2.75</b>	3.25
BOR5CTD01	5.0mm x 2.0mm	1	<b>6.00</b>	6.25
BOR6CTD01	6.3mm x 2.5mm	1	<b>6.75</b>	6.95
BOR8CTD01	8.0mm x 3.15mm	1	<b>8.50</b>	8.95

## Borman Centre Drill Set 5 Piece



- 5 sizes: 3.15, 4, 5, 6.3 and 8mm.

### Borman

CODE	Description	Unit	10+	4+	1+
BOR005SET	Centre Drill Set 5 Piece		<b>15.95</b>	18.25	20.50

## Borman 1/2" Workshop Keyed Chuck



- Well-made chuck at an affordable price.
- Capacity: 0 - 1 1/2"/13mm.
- Internal taper mount: J6.

CODE	Description	Unit	1+
BOR136KYC	Keyed Chuck	1	<b>22.50</b>

## Borman 1/2" Heavy Duty Keyless Chuck



- Rugged chuck for heavy duty applications.
- Precision made and carefully hardened.
- Capacity: 0 - 1/2"/13mm. Internal taper mount: J6.

CODE	Description	Unit	1+
BOR136HDC	Keyless Chuck	1	<b>49.95</b>

## Replacement Chuck Keys



- Avoid loss of time by always having a spare chuck key near at hand.
- Type K3.

CODE	Size	Unit	1+
DCK300REP	K3	1	<b>6.25</b>

## H.S.S. Drill Set 13 Piece



- HSS ground drill set with TiN coating.
- Suitable for drilling metal, wood and plastics.
- Supplied in a metal flip up case.
- Sizes 1.5-6.5mm in 0.5mm increments.

CODE	Description	Unit	4+	1+
DHS130SET	H.S.S. Drill Set 13 Piece Set		<b>7.25</b>	9.00

## Drill Stock Box 170 Piece



- Convenient metal box of HSS jobber drills.
- Contains 10 each of the following sizes; 1mm-8mm in 0.5mm increments; and 5 each of 8.5mm, 9mm, 9.5mm and 10mm.

CODE	Description	Unit	1+
KNZ170SET	Drill Stock Set 170 Piece		<b>67.50</b>

## TiN Coated H.S.S. Reduced Shank Drills 8 Piece



- Metric set of HSS drills sized 14, 16, 18, 19, 21, 22, 24 and 25mm all with 1/2" shanks.
- TiN coated for extra wear resistance.

CODE	Description	Unit	1+
RS1325SET	Reduced Shank Drills Set 8 Piece		<b>56.25</b>

## H.S.S. Reduced Shank Drills



- Large HSS twist drills having ½" diameter shanks, which enables them to be used in drill chucks.
- High quality M2 grade H.S.S. steel.
- Fully ground, 150mm overall length.

CODE	Diameter	Unit	4+	1+
BOR014RSD	14mm	1	<b>10.95</b>	11.95
BOR145RSD	14.5mm	1	<b>12.95</b>	14.25
BOR015RSD	15mm	1	<b>12.95</b>	14.25
BOR155RSD	15.5mm	1	<b>15.25</b>	16.75
BOR016RSD	16mm	1	<b>15.25</b>	16.75
BOR165RSD	16.5mm	1	<b>17.95</b>	19.75
BOR017RSD	17mm	1	<b>17.95</b>	19.75
BOR175RSD	17.5mm	1	<b>20.50</b>	22.50
BOR018RSD	18mm	1	<b>20.50</b>	22.50
BOR185RSD	18.5mm	1	<b>22.75</b>	26.00
BOR019RSD	19mm	1	<b>23.25</b>	25.50
BOR195RSD	19.5mm	1	<b>26.25</b>	28.95
BOR020RSD	20mm	1	<b>26.25</b>	28.95
BOR022RSD	22mm	1	<b>33.50</b>	36.75
BOR025RSD	25mm	1	<b>44.75</b>	49.25

## H.S.S. Taper Shank Drills



- Good quality European made taper shank H.S.S. drills.

CODE	Diameter	Unit	2+	1+
TSD000130	13mm 1MT	1	<b>10.00</b>	11.25
TSD000140	14mm 1MT	1	<b>11.75</b>	13.00
TSD000150	15mm 2MT	1	<b>12.25</b>	13.50
TSD000160	16mm 2MT	1	<b>12.75</b>	13.75
TSD000170	17mm 2MT	1	<b>13.75</b>	15.25
TSD000180	18mm 2MT	1	<b>14.00</b>	15.75
TSD000190	19mm 2MT	1	<b>16.00</b>	17.50
TSD000200	20mm 2MT	1	<b>19.75</b>	21.50
TSD000210	21mm 2MT	1	<b>22.25</b>	24.50
TSD000220	22mm 2MT	1	<b>22.75</b>	25.00
TSD000230	23mm 2MT	1	<b>22.25</b>	24.50
TSD000240	24mm 3MT	1	<b>27.00</b>	29.75
TSD000250	25mm 3MT	1	<b>27.00</b>	30.00

## Borman H.S.S. Long Series Drills



- Premium quality straight shank long series high speed steel jobber drills.
- Supplied as individual drills

### Borman

CODE	Diameter	Overall Length	Unit	10+	1+
BOR020L01	2.0mm	85mm	1	<b>1.50</b>	1.75
BOR025L01	2.5mm	95mm	1	<b>1.50</b>	2.00
BOR030L01	3.0mm	100mm	1	<b>1.50</b>	2.00
BOR035L01	3.5mm	112mm	1	<b>1.50</b>	2.00
BOR040L01	4.0mm	119mm	1	<b>1.50</b>	2.25
BOR045L01	4.5mm	126mm	1	<b>2.00</b>	2.25
BOR050L01	5.0mm	132mm	1	<b>2.25</b>	2.50
BOR055L01	5.5mm	139mm	1	<b>2.50</b>	3.00
BOR060L01	6.0mm	139mm	1	<b>2.75</b>	3.50

## Borman H.S.S. Industrial Drills Pack of 10



- Premium quality straight shank high speed steel jobber drills.
- Suitable for cutting steel, wood and plastics.

### Borman

CODE	Diameter	Unit	5+	1+
BOR010D10	1.0mm	Pack of 10	<b>3.75</b>	4.75
BOR011D10	1.1mm	Pack of 10	<b>3.75</b>	4.75
BOR012D10	1.2mm	Pack of 10	<b>3.75</b>	4.75
BOR013D10	1.3mm	Pack of 10	<b>3.75</b>	4.75
BOR014D10	1.4mm	Pack of 10	<b>3.75</b>	4.75
BOR015D10	1.5mm	Pack of 10	<b>3.75</b>	4.75
BOR016D10	1.6mm	Pack of 10	<b>3.75</b>	4.75
BOR017D10	1.7mm	Pack of 10	<b>3.75</b>	4.75
BOR018D10	1.8mm	Pack of 10	<b>3.75</b>	4.75
BOR019D10	1.9mm	Pack of 10	<b>3.75</b>	4.75
BOR020D10	2.0mm	Pack of 10	<b>4.50</b>	5.00
BOR021D10	2.1mm	Pack of 10	<b>4.50</b>	5.00
BOR022D10	2.2mm	Pack of 10	<b>4.50</b>	5.00
BOR023D10	2.3mm	Pack of 10	<b>4.50</b>	5.00
BOR024D10	2.4mm	Pack of 10	<b>4.50</b>	5.00
BOR025D10	2.5mm	Pack of 10	<b>4.50</b>	5.00
BOR026D10	2.6mm	Pack of 10	<b>4.50</b>	5.00
BOR027D10	2.7mm	Pack of 10	<b>4.50</b>	5.00
BOR028D10	2.8mm	Pack of 10	<b>4.50</b>	5.00
BOR029D10	2.9mm	Pack of 10	<b>4.50</b>	5.00
BOR030D10	3.0mm	Pack of 10	<b>5.00</b>	5.75
BOR031D10	3.1mm	Pack of 10	<b>5.00</b>	5.75
BOR032D10	3.2mm	Pack of 10	<b>5.00</b>	5.75
BOR033D10	3.3mm	Pack of 10	<b>5.00</b>	5.75
BOR034D10	3.4mm	Pack of 10	<b>5.25</b>	6.25
BOR035D10	3.5mm	Pack of 10	<b>5.25</b>	6.25
BOR036D10	3.6mm	Pack of 10	<b>5.25</b>	6.25
BOR037D10	3.7mm	Pack of 10	<b>5.75</b>	6.75
BOR038D10	3.8mm	Pack of 10	<b>5.75</b>	6.75
BOR039D10	3.9mm	Pack of 10	<b>5.75</b>	6.75
BOR040D10	4.0mm	Pack of 10	<b>6.00</b>	7.25
BOR041D10	4.1mm	Pack of 10	<b>6.00</b>	7.25
BOR042D10	4.2mm	Pack of 10	<b>6.25</b>	7.25
BOR043D10	4.3mm	Pack of 10	<b>6.25</b>	7.25
BOR044D10	4.4mm	Pack of 10	<b>6.25</b>	7.25
BOR045D10	4.5mm	Pack of 10	<b>6.75</b>	8.00
BOR046D10	4.6mm	Pack of 10	<b>6.75</b>	8.00
BOR047D10	4.7mm	Pack of 10	<b>6.75</b>	8.00
BOR048D10	4.8mm	Pack of 10	<b>7.25</b>	8.50
BOR049D10	4.9mm	Pack of 10	<b>7.25</b>	8.50
BOR050D10	5.0mm	Pack of 10	<b>7.25</b>	8.50
BOR051D10	5.1mm	Pack of 10	<b>7.25</b>	9.00
BOR052D10	5.2mm	Pack of 10	<b>7.25</b>	9.00
BOR053D10	5.3mm	Pack of 10	<b>8.25</b>	9.75
BOR054D10	5.4mm	Pack of 10	<b>7.50</b>	9.00
BOR055D10	5.5mm	Pack of 10	<b>8.50</b>	10.50
BOR056D10	5.6mm	Pack of 10	<b>8.50</b>	10.50
BOR057D10	5.7mm	Pack of 10	<b>9.00</b>	10.75
BOR058D10	5.8mm	Pack of 10	<b>9.00</b>	10.75
BOR059D10	5.9mm	Pack of 10	<b>9.75</b>	11.50
BOR060D10	6.0mm	Pack of 10	<b>10.25</b>	12.25

## Borman H.S.S. Industrial Drills Individual

### Borman

CODE	Diameter	Unit	5+	1+
BOR065D01	6.5mm	1	<b>1.25</b>	1.50
BOR068D01	6.8mm	1	<b>1.50</b>	1.75
BOR070D01	7.0mm	1	<b>1.50</b>	2.00
BOR075D01	7.5mm	1	<b>1.75</b>	2.25
BOR080D01	8.0mm	1	<b>2.00</b>	2.25
BOR085D01	8.5mm	1	<b>2.00</b>	2.50
BOR090D01	9.0mm	1	<b>2.25</b>	2.75
BOR095D01	9.5mm	1	<b>2.50</b>	3.50
BOR100D01	10.0mm	1	<b>3.00</b>	3.75
BOR102D01	10.2mm	1	<b>3.50</b>	4.00
BOR105D01	10.5mm	1	<b>3.75</b>	4.50
BOR110D01	11.0mm	1	<b>4.00</b>	5.25
BOR115D01	11.5mm	1	<b>4.50</b>	5.75
BOR120D01	12.0mm	1	<b>6.25</b>	8.25
BOR125D01	12.5mm	1	<b>6.75</b>	8.50
BOR130D01	13.0mm	1	<b>7.25</b>	9.00

## Borman H.S.S. Drill Set 19 Piece



- H.S.S. drill sets for general use in wood, metal and plastics.
- 1 - 10mm in 0.5 mm increments.
- The drills are presented in attractive, strong and functional metal pop-up cases.

### Borman

CODE	Description	Unit	3+	1+
KALDS19ST	Kaliber Drill Set	19 Piece	<b>13.00</b>	14.50

## Borman H.S.S. Drill Set 25 Piece



- H.S.S. drill sets for general use in wood, metal and plastics.
- 1 - 13 mm in 0.5mm increments.
- The drills are presented in attractive, strong and functional metal pop-up cases.

### Borman

CODE	Description	Unit	3+	1+
KALDS25ST	Kaliber Drill Set	25 Piece	<b>23.50</b>	24.75



## The Borman Range Professional HSS Drills



- Made from M2 grade HSS with a 135 degree angle and split point.
- Faster penetration without sacrificing the drill strength.
- Fully ground for accuracy.

CODE	Diameter	Unit	5+	1+
BOR010PRD	1.0mm	Pack of 10	5.25	6.00
BOR015PRD	1.5mm	Pack of 10	5.25	6.00
BOR020PRD	2.0mm	Pack of 10	5.25	6.00
BOR025PRD	2.5mm	Pack of 10	5.25	6.00
BOR030PRD	3.0mm	Pack of 10	6.00	6.75
BOR032PRD	3.2mm	Pack of 10	6.75	7.75
BOR033PRD	3.3mm	Pack of 10	6.75	7.75
BOR035PRD	3.5mm	Pack of 10	7.75	9.00
BOR040PRD	4.0mm	Pack of 10	8.50	10.00
BOR042PRD	4.2mm	Pack of 10	9.00	10.25
BOR045PRD	4.5mm	Pack of 10	9.00	10.25
BOR050PRD	5.0mm	Pack of 10	10.00	11.50
BOR055PRD	5.5mm	Pack of 10	11.75	13.75
BOR060PRD	6.0mm	Pack of 10	13.75	16.00
BOR065PRD	6.5mm	1	2.00	2.25
BOR068PRD	6.8mm	1	2.25	2.50
BOR070PRD	7.0mm	1	2.25	2.50
BOR075PRD	7.5mm	1	2.50	3.00
BOR080PRD	8.0mm	1	3.00	3.50
BOR085PRD	8.5mm	1	3.50	3.75
BOR090PRD	9.0mm	1	4.00	4.75
BOR100PRD	10.0mm	1	4.50	5.25

## The Borman Range Professional HSS Drill Set 19 Piece



- 19 piece:- 1-10mm x 0.5mm increments.

**Borman**

CODE	Description	Unit	1+
BOR190PRD	Professional Drill Set	19 Piece	38.25

## Dormer H.S.S. Drills



- High quality H.S.S. with TIN tip coating for increased tool life and performance.
- Self-centring split point for superb hole quality and positional accuracy.
- Drills steel, stainless, cast iron, ceramics, plastics and many other materials with ease.
- Made to DIN 338RN/BS328/ISO 235 standards.
- Note: sizes under 2.0mm are NOT TIN Coated.

CODE	Diameter	Unit	10+	4+	1+
DOR010ATN	1.0mm	1	1.65	1.95	2.35
DOR015ATN	1.5mm	1	1.45	1.75	2.10
DOR020ATN	2.0mm	1	1.20	1.45	1.65
DOR022ATN	2.2mm	1	1.45	1.75	2.00
DOR023ATN	2.3mm	1	1.45	1.75	2.00
DOR025ATN	2.5mm	1	1.35	1.65	1.95
DOR026ATN	2.6mm	1	1.50	1.80	2.10
DOR028ATN	2.8mm	1	1.50	1.80	2.10
DOR029ATN	2.9mm	1	1.45	1.75	2.05
DOR030ATN	3.0mm	1	1.35	1.65	1.95
DOR032ATN	3.2mm	1	1.55	1.85	2.20
DOR033ATN	3.3mm	1	1.40	1.70	1.95
DOR035ATN	3.5mm	1	1.65	1.95	2.30
DOR038ATN	3.8mm	1	1.95	2.35	2.75
DOR040ATN	4.0mm	1	1.75	2.15	2.50
DOR041ATN	4.1mm	1	1.95	2.35	2.75
DOR042ATN	4.2mm	1	1.80	2.20	2.60
DOR044ATN	4.4mm	1	2.05	2.50	2.95
DOR045ATN	4.5mm	1	2.05	2.50	2.95
DOR048ATN	4.8mm	1	2.25	2.75	3.20
DOR049ATN	4.9mm	1	2.20	2.65	3.10
DOR050ATN	5.0mm	1	2.15	2.60	3.05
DOR051ATN	5.1mm	1	2.45	2.95	3.50
DOR052ATN	5.2mm	1	2.50	3.05	3.60
DOR053ATN	5.3mm	1	2.55	3.10	3.65
DOR055ATN	5.5mm	1	2.85	3.45	4.05
DOR056ATN	5.6mm	1	2.95	3.65	4.30
DOR060ATN	6.0mm	1	2.75	3.35	
DOR061ATN	6.1mm	1	3.25	3.95	
DOR062ATN	6.2mm	1	3.25	3.95	
DOR063ATN	6.3mm	1	3.30	4.00	
DOR064ATN	6.4mm	1	3.35	4.05	
DOR065ATN	6.5mm	1	3.45	4.20	
DOR068ATN	6.8mm	1	3.75	4.55	
DOR070ATN	7.0mm	1	3.95	4.80	
DOR075ATN	7.5mm	1	4.20	5.10	
DOR080ATN	8.0mm	1	4.65	5.65	
DOR082ATN	8.2mm	1	5.10	6.20	
DOR085ATN	8.5mm	1	5.30	6.40	
DOR086ATN	8.6mm	1	6.30	7.65	
DOR090ATN	9.0mm	1	6.20	7.50	
DOR095ATN	9.5mm	1	6.75	8.15	
DOR100ATN	10.0mm	1	7.30	8.95	
DOR102ATN	10.2mm	1	9.30	11.25	
DOR103ATN	10.3mm	1	9.75	5.80	
DOR105ATN	10.5mm	1	9.50	11.50	
DOR110ATN	11.0mm	1	10.95	13.25	
DOR115ATN	11.5mm	1	11.50	14.00	
DOR120ATN	12.0mm	1	12.60	15.30	
DOR125ATN	12.5mm	1	13.75	16.75	
DOR130ATN	13.0mm	1	14.95	17.95	

## Dormer H.S.S. Drill Sets 19, 25 or 51 Piece Set

- High quality H.S.S. with TIN tip coating for increased tool life and performance.
- Self-centring split point for superb hole quality and positional accuracy.
- Drills steel, stainless, cast iron, ceramics, plastics and many other materials with ease.
- Made to DIN 338RN/BS328/ISO 235 standards.
- Note: sizes under 2.0mm are NOT TIN Coated.



CODE	Description	Unit	1+
DOR190SET	1-10mm x 0.5mm	19 Piece Set	59.95
DOR202SET	1-6mm x 0.1mm	51 Piece Set	119.50
DOR204SET	1-13mm x 0.5mm	25 Piece Set	155.00

## Borman Cone Drills 3 Piece



- Infinite range of sizes on one tool – the deeper the cut, the larger the hole.
- Drills thin gauge sheets without snatch or distortion.
- Repetitive holes can be drilled using a washer, mounted on the drill as a stop.

**Borman**

CODE	Description	Unit	1+
BORSET3CD	Borman Cone Drills	3 Piece	33.75

## Borman Step Drills 3 Piece



- Produces parallel holes in sheet materials up to 3-4mm thick.
- Range of sizes on one hole – economise on drills and changeover time.
- Precision ground axial and radial relief ensure cutting edge is highest point.

**Borman**

CODE	Description	Unit	1+
BORST3SPD	Step Drills	3 Piece Set	37.00

## Borman 3 Flute HSS Countersink Set 6 Piece



- Multi-purpose countersink for metal, wood and plastics.
- Triple flute for chatter-free performance cool-running and excellent chip clearance.
- Set consists of 6.3, 8.3, 10.4, 12.4, 16.5 and 20.5mm in flip up metal box.

**Borman**

CODE	Description	Unit	1+
BOR6PC3FC	3 Flute Countersink Set	6 Piece	29.75

## Borman HSS 3 Flute Countersink 12.4mm



- Multi-purpose countersink, ideal for use with metal, wood and plastics.
- Triple flute for chatter-free performance, cool-running and excellent chip clearance.
- HSS ground flutes and shank.

CODE	Description	Unit	10+	4+	1+
BOR012CSK	12.4mm/1/2"	1	4.75	5.25	6.00

## Professional H.S.S. 3 Flute Countersink



- High quality M2 grade H.S.S. flutes have an accurate radial and axial relief for optimum edge sharpness.
- Chatter-free cool-running tool, giving excellent chip clearance, a long life and a superior surface finish.
- Suitable for use on most industrial materials including ferrous and non-ferrous metals, plastics and wood.

CODE	Description	Unit	10+	4+	1+
BOR010TFC	10.4mm	1	8.25	9.25	10.50
BOR012TFC	12.4mm	1	9.25	10.75	11.75
BOR016TFC	16.5mm	1	15.25	16.25	17.75

## Borman Hole Type Countersink



- Snail type countersink for deburring.
- Produces a planed finish on timber.

**Borman**

CODE	Description	Unit	1+
BOR205HTC	2-5mm	1	10.50
BOR510HTC	5-10mm	1	11.75

## Hand Countersink



- Plastic handle with H.S.S. countersink.
- For use with wood, metal and plastic.

CODE	Description	Unit	1+
CSK090HND	Hand Countersink	1	4.50

## Borman H.S.S. Lip and Spur Drill Set 15 Piece



- Popular lip and spur wood drills in H.S.S., as a 15 piece set.
- Centre point for accurate location and scribing spurs to ensure clean entry.
- Suitable for drilling hard and soft woods, plywood, MDF and chipboard.
- Sizes 3-10mm x 0.5mm increments.



**Borman**

CODE	Description	Unit	1+
KALLS15ST	Lip and Spur Set	15 Piece	20.75

## Tapered Plug Cutter Set 3 Piece



- Designed to cut slightly tapered plugs.
- Plug fits perfectly, with a nearly invisible line.
- 3/8" shanks.
- Set of 3 popular metric sizes, 6, 8 and 10mm.

CODE	Description	Unit	1+
PLC003TPR	Plug Cutter Set	3 Piece	14.95

## Auger Bits



- Screw point and scribing cutter.
- Suitable for use with power tools.

**Standard Series - 235mm (overall)**

CODE	Diameter	Unit	4+	1+
BOR006AGB	6mm	1	2.25	2.50
BOR008AGB	8mm	1	2.70	2.95
BOR010AGB	10mm	1	2.95	3.20
BOR012AGB	12mm	1	3.20	3.50
BOR014AGB	14mm	1	3.75	3.95
BOR016AGB	16mm	1	3.80	4.10
BOR019AGB	19mm	1	4.90	5.25
BOR020AGB	20mm	1	4.95	5.50
BOR022AGB	22mm	1	5.75	6.25
BOR024AGB	24mm	1	6.50	6.95
BOR025AGB	25mm	1	7.25	7.95
BOR026AGB	26mm	1	7.75	8.50
BOR028AGB	28mm	1	8.25	8.95
BOR030AGB	30mm	1	9.25	9.95
BOR032AGB	32mm	1	9.95	10.75

## Auger Bit Set 6 Piece



- Sizes 10, 12, 14, 16, 18, and 20mm.
- Overall length 230mm, hexagon shanks.

CODE	Description	Unit	4+	1+
AGB600SET	Auger Bit Set	6 Piece	29.95	33.95

## Flat Bit Set 8 Piece



- 140mm overall length.
- Contents: 10, 13, 16, 20, 22, 25, 32 and 38mm.

CODE	Description	Unit	4+	1+
QCS800FBS	Flat Bit Set	8 Piece	26.25	28.95

## Forstner Bit Set 5 Piece



- 90mm overall length.
- Contents: 15, 20, 25, 30 and 35mm.

CODE	Description	Unit	4+	1+
FBS500SET	Forstner Bit Set	5 Piece	<b>27.00</b>	29.25

## Forstner Bit Set 15 Piece



- Versatile woodboring bits for producing clean, accurate flat bottomed holes.
- 10mm diameter shanks.
- Sizes 10, 12, 16, 20, 22, 25, 28, 30, 35, 38, 42, 45, 48, 50, 54mm.
- Overall length 90mm.

CODE	Description	Unit	4+	1+
FBS150SET	Forstner Bit Set	15 Piece	<b>64.75</b>	70.25

## Sawtooth Forstner Bits



- Sawtooth forstner bits in the popular 150mm length for deep hole boring.
- Producing holes at an angle, overlapping or at close centres.
- They bore smooth, flat bottomed, clean holes in all types of wood - with or across the grain.

CODE	Size	Unit	1+
BOR380SFB	3/8"	1	<b>15.75</b>
BOR120SFB	1/2"	1	<b>15.75</b>
BOR580SFB	5/8"	1	<b>17.25</b>
BOR340SFB	3/4"	1	<b>17.50</b>
BOR780SFB	7/8"	1	<b>18.75</b>
BOR100SFB	1"	1	<b>20.25</b>
BOR118SFB	1 1/8"	1	<b>23.75</b>
BOR114SFB	1 1/4"	1	<b>23.75</b>
BOR138SFB	1 3/8"	1	<b>25.75</b>
BOR112SFB	1 1/2"	1	<b>27.75</b>
BOR158SFB	1 5/8"	1	<b>31.95</b>
BOR134SFB	1 3/4"	1	<b>32.50</b>
BOR178SFB	1 7/8"	1	<b>32.50</b>
BOR200SFB	2"	1	<b>32.75</b>
BOR212SFB	2 1/2"	1	<b>51.95</b>
BOR300SFB	3"	1	<b>63.50</b>

## HSS Holesaw Set 6 Piece



- Bi-metal H.S.S. holesaw for use on wood, metal and plastic.
- Six popular sizes in a storage case.
- Includes arbors and pilot drill to suit cutters.
- Sizes 19, 22, 29, 38, 44 & 57mm.

CODE	Size	Unit	2+	1+
HSW600SET	H.S.S. Holesaw Set	6 Piece	<b>39.95</b>	45.00

## H.S.S. Holesaws Set 7 Piece



- These Dart holesaws are all compatible with standard holesaw arbors and pilot drills.
- These variable pitched holesaws are suitable for cutting metal, wood and plastic.
- Includes 19, 22, 29, 38, 44, 51 and 57mm.

CODE	Description	Unit	2+	1+
DAR710SET	Holesaw Set	7 Piece	<b>59.50</b>	64.25

## H.S.S. Holesaws Set 9 Piece



- These Dart holesaws are all compatible with standard holesaw arbors and pilot drills.
- These variable pitched holesaws are suitable for cutting metal, wood and plastic.
- Includes 16, 20, 25, 32, 40, 52, 64, 70 and 82mm.

CODE	Description	Unit	2+	1+
DAR913SET	Holesaw Set	9 Piece	<b>89.25</b>	96.50

## Holesaw Arbors



- DAR1430AR Arbor for 14-30mm holesaws with 3/8" hex shank.
- DAR3221AR Arbor for 32-210mm holesaws with 1/2" hex shank.

CODE	Size	Unit	2+	1+
DAR1430AR	14-30mm	1	<b>7.50</b>	8.25
DAR3221AR	31-210mm	1	<b>11.75</b>	12.95

## Pilot Drills

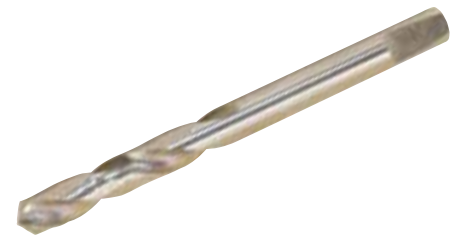

- HSS replacement pilot drill for arbors.

CODE	Diameter	Unit	2+	1+
DAR075PDR	75mm	1	<b>14.95</b>	16.50
DAR104PDR	104mm	1	<b>16.25</b>	17.75

## Extension Bar For 32-210mm Arbor



- 300mm/12" bar to suit arbor (Code DAR3221AR).

CODE	Description	Unit	2+	1+
DAR120EXT	Extension Bar	1	<b>9.00</b>	10.50

## Ejector Spring



- The Dart ejector spring fits over the pilot drill and pushes the core out of the saw after the cut 44mm long.

CODE	Description	Unit	1+
DAR044EJS	Ejector Spring	1	<b>1.20</b>

## H.S.S. Holesaws

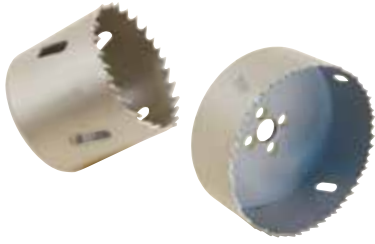

- HSS cutting edge.
- Compatible with standard holesaw arbors and pilot drills.

CODE	Diameter	Unit	2+	1+
DAR014HSW	14mm	1	4.95	5.50
DAR016HSW	16mm	1	4.95	5.50
DAR017HSW	17mm	1	4.95	5.50
DAR019HSW	19mm	1	4.95	5.50
DAR020HSW	20mm	1	4.95	5.50
DAR021HSW	21mm	1	5.25	5.75
DAR022HSW	22mm	1	5.25	5.75
DAR024HSW	24mm	1	5.95	6.50
DAR025HSW	25mm	1	6.25	6.75
DAR027HSW	27mm	1	6.25	7.50
DAR029HSW	29mm	1	7.25	7.95
DAR030HSW	30mm	1	7.25	7.95
DAR032HSW	32mm	1	6.95	7.75
DAR033HSW	33mm	1	8.25	8.95
DAR035HSW	35mm	1	8.25	8.95
DAR038HSW	38mm	1	9.25	10.25
DAR040HSW	40mm	1	9.25	10.25
DAR041HSW	41mm	1	9.25	10.75
DAR043HSW	43mm	1	9.25	10.75
DAR044HSW	44mm	1	9.95	10.95
DAR045HSW	45mm	1	9.95	10.95
DAR046HSW	46mm	1	9.95	10.95
DAR048HSW	48mm	1	9.95	10.95
DAR050HSW	50mm	1	9.95	10.95
DAR051HSW	51mm	1	11.25	12.25
DAR052HSW	52mm	1	11.25	12.25
DAR054HSW	54mm	1	11.25	12.25
DAR055HSW	55mm	1	11.75	12.95
DAR057HSW	57mm	1	11.75	12.95
DAR060HSW	60mm	1	12.25	13.50
DAR062HSW	62mm	1	12.25	13.50
DAR064HSW	64mm	1	12.95	14.25
DAR067HSW	67mm	1	12.95	14.25
DAR068HSW	68mm	1	13.25	14.50
DAR070HSW	70mm	1	13.25	14.50
DAR073HSW	73mm	1	13.25	14.50
DAR075HSW	75mm	1	13.25	14.50
DAR076HSW	76mm	1	13.25	14.50
DAR079HSW	79mm	1	13.50	14.95
DAR083HSW	83mm	1	13.95	15.25
DAR086HSW	86mm	1	14.25	15.75
DAR089HSW	89mm	1	15.25	16.75
DAR092HSW	92mm	1	15.95	17.50
DAR095HSW	95mm	1	16.50	18.25
DAR098HSW	98mm	1	18.25	19.95
DAR100HSW	100mm	1	18.95	20.75
DAR102HSW	102mm	1	18.95	20.95
DAR105HSW	105mm	1	20.75	22.75
DAR108HSW	108mm	1	20.95	22.95
DAR111HSW	111mm	1	26.25	28.95

## H.S.S. Holesaws *continued...*

CODE	Diameter	Unit	2+	1+
DAR114HSW	114mm	1	26.75	29.50
DAR121HSW	121mm	1	30.95	33.95
DAR127HSW	127mm	1	34.25	37.50
DAR133HSW	133mm	1	34.95	38.50
DAR140HSW	140mm	1	38.75	42.50
DAR146HSW	146mm	1	40.75	44.75
DAR152HSW	152mm	1	43.95	48.25
DAR160HSW	160mm	1	44.25	48.75
DAR165HSW	165mm	1	44.95	49.50
DAR168HSW	168mm	1	45.25	49.75
DAR177HSW	177mm	1	48.75	53.50
DAR200HSW	200mm	1	52.95	58.25
DAR210HSW	210mm	1	56.75	62.25

## Pro TCT Circular Saw Woodcutting Blades Alternative Bevel Positive Hook



- Fully hardened body (40-44 Rockwell) with generous sized TCT tips and expansion slots
- General purpose timber cutting blade for portable and static machines.
- Alternate top bevel tooth form with positive rake angle.

CODE	Dia.	Teeth	Bore	1+
P1251612W	125	16	12.7	15.75
P1251620W	125	16	20	15.75
P1301620W	130	16	20	14.50
P1341620W	134	16	20	14.75
P1362410C	136	24	10 (cordless)	20.25
P1401620W	140	16	20	15.00
P1501820W	150	18	20	16.00
P1502410C	150	24	10 (cordless)	21.00
P1503020W	150	30	20	18.00
P1601820W	160	18	20	17.75
P1603020W	160	30	20	19.50
P1605020W	160	50	20	23.25
P1651830W	165	18	30	18.75
P1652410C	165	24	10 (cordless)	23.25
P1653030W	165	30	30	20.50
P1655020W	165	50	20	24.25
P1803016W	180	30	16	21.75
P1803030W	180	30	30	21.75
P1842416W	184	24	16	21.00
P1842430W	184	24	30	21.00
P1844016W	184	40	16	24.25
P1844030W	184	40	30	24.25
P1846016W	184	60	16	30.00
P1846030W	184	60	30	30.00
P1902016W	190	20	16	21.75
P1902030W	190	20	30	21.75
P1904016W	190	40	16	25.75
P1904030W	190	40	30	25.75
P2002016W	200	20	16	25.50

## Pro TCT Circular Saw Woodcutting Blades Alternative Bevel Positive Hook *continued...*

CODE	Dia.	Teeth	Bore	1+
P2002030W	200	20	30	25.50
P2004016W	200	40	16	30.00
P2004030W	200	40	30	30.00
P2104030W	210	40	30	32.00
P2302030W	230	20	30	27.00
P2304030W	230	40	30	32.25
P2353030W	235	30	30	29.75
P2354030W	235	40	30	32.50
P2356030W	235	60	30	36.50
P2502430W	250	24	30	30.50
P2504030W	250	40	30	33.75
P2506030W	250	60	30	35.75
P2508030W	250	80	30	41.50
P2603030W	260	30	30	36.50
P2606030W	260	60	30	40.50
P3003030W	300	30	30	45.50
P3004030W	300	40	30	48.25
P3004830W	300	48	30	49.50
P3006030W	300	60	30	51.25
P3007230W	300	72	30	54.50
P3009630W	300	96	30	61.00
P3153030W	315	30	30	55.00
P3154830W	315	48	30	66.75
P3156030W	315	60	30	70.50
P3158030W	315	80	30	72.25
P3504030W	350	40	30	72.50
P3505430W	350	54	30	81.75
P3508430W	350	84	30	88.00
P4004030W	400	40	30	92.25
P4006030W	400	60	30	101.00

## Pro TCT Circular Saw Woodcutting Chopsaw Blades 0° ATB



- Fully hardened body (40-44 Rockwell) with generous sized TCT tips and expansion slots.
- For use on chopsaws, and with a zero degree rake angle to minimize snatching.
- Alternate top bevel tooth form for woodcutting.

CODE	Dia.	Teeth	Bore	1+
P20524018	205	24 - 0°	18	31.75
P20542018	205	42 - 0°	18	33.00
P21624030	216	24 - 0°	30	24.25
P21648030	216	48 - 0°	30	28.75
P21660030	216	60 - 0°	30	43.00
P25060030	250	60 - 0°	30	35.75
P25080030	250	80 - 0°	30	39.50
P30096030	300	96 - 0°	30	66.25
P30540030	305	40 - 0°	30	50.75
P30560030	305	60 - 0°	30	55.25

## Pro TCT Circular Saw Aluminium Cutting Blades 5° Negative Hook



- Fully hardened body (40-44 Rockwell) with generous sized TCT tips and expansion slots.
- Trapezoidal tooth form (triple chip) with a negative rake angle of -5 degrees, making it ideal for cutting aluminium and non-ferrous materials.
- Also used on laminates, plywood and particle boards.

CODE	Dia.	Teeth	Bore	1+
P1844830A	184	48	30	25.75
P2006030A	200	60	30	35.25
P2164830A	216	48	30	40.75
P2166030A	216	60	30	47.75
P2168030A	216	80	30	51.00
P2508030A	250	80	30	54.75
P3009630A	300	96	30	68.50
P3059630A	305	96T	30	69.00
P3158030A	315	80	30	73.50
P3508430A	350	84	30	85.00

## HSS Cutting Off Circular Blade



- Universal mounting holes fit most machines.
- Steam treated surface for improved performance.
- 250mm diameter. Thickness 2mm x 32mm bore.
- Available with two tooth pitches: 4mm pitch – for steel solid and tube up to 10mm section. 6mm pitch – for steel solid and tube up to 50mm section and non-ferrous up to 30mm section.

CODE	Dia. x Tooth Pitch	Unit	1+
BRK2504CB	250mm x 4mm	1	85.50
BRK2506CB	250mm x 6mm	1	85.50
BRK2706CB	275mm x 6mm	1	118.25
BRK3105CB	315mm x 5mm	1	145.75

### SEE CONSUMABLES

## Cutting Compounds and Fluids



## TCT Planer Blades

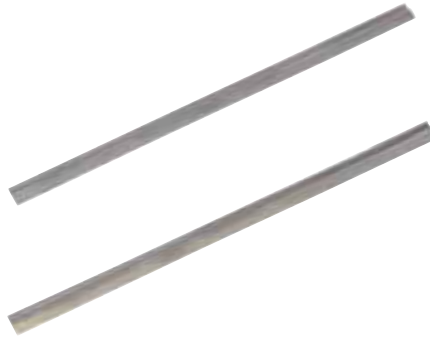

- Reversible solid tungsten carbide blades for long life.
- Excellent performance on solid wood and man-made boards.
- Supplied as a pair.

CODE	Description	Unit	1+
PLB080TCT	80mm	1	12.95
PLB082TCT	82mm	1	12.95

## No. 101A Jigsaw blades Pack of 5



- High quality jigsaw blades with bayonet mount to fit Festool, Bosch, AEG, Hitachi and Makita machines and many others with the same mount.
- Taper ground jigsaw blades No.101A, 50mm long with a pitch of 1.2mm, 20tpi.
- Clean cutting on most woods and boards ideal for curves.

CODE	Description	Unit	4+	1+
JSBT101A0	No. 101A	Pack of 5	6.50	7.25

## No. 111C Jigsaw blades Pack of 5



- High quality jigsaw blades with bayonet mount to fit Festool, Bosch, AEG, Hitachi and Makita machines and many others with the same mount.
- Jigsaw blades No.111C, 75mm long with a pitch of 3mm, 8tpi.
- Coarse cut for hard and softwood below 60mm thick.

CODE	Description	Unit	4+	1+
JSBT111C0	No. 111C	Pack of 5	3.50	3.90

## No. 144D Jigsaw blades Pack of 5



- High quality jigsaw blades with bayonet mount to fit Festool, Bosch, AEG, Hitachi and Makita machines and many others with the same mount.
- Ground tooth jigsaw blades No.144D, 75mm long with a pitch of 4mm, 6tpi.
- Quick cut on hard and softwood and chipboard below 60mm thick.

CODE	Description	Unit	4+	1+
JSBT144D0	No. 144D	Pack of 5	4.95	5.50

## No. 101B Jigsaw blades Pack of 5



- High quality jigsaw blades with bayonet mount to fit Festool, Bosch, AEG, Hitachi and Makita machines and many others with the same mount.
- Taper ground jigsaw blades No.101B, 75mm long with a pitch of 2.5mm, 10tpi.
- Clean cutting on most woods and boards below 30mm thick.

CODE	Description	Unit	4+	1+
JSBT101B0	No. 101B	Pack of 5	6.50	7.25

## No. 101D Jigsaw blades Pack of 5



- High quality jigsaw blades with bayonet mount to fit Festool, Bosch, AEG, Hitachi and Makita machines and many others with the same mount.
- Taper ground jigsaw blades No.101D, 75mm long with a pitch of 4mm, 6tpi.
- Clean cutting on most woods and boards below 60mm thick.

CODE	Description	Unit	4+	1+
JSBT101D0	No. 101D	Pack of 5	6.50	7.25

## No. 118G Jigsaw Blades H.S.S.

Pack of 5



- High quality jigsaw blades with bayonet mount to fit Festool, Bosch, AEG, Hitachi and Makita machines and many others with the same mount.
- Jigsaw blades No.118G, 50mm long with a pitch of 0.7mm, 36tpi.
- For cutting mild steel, aluminium and non-ferrous metals below 2mm thick.
- Use a wood backing when cutting thicknesses below 1mm.

CODE	Description	Unit	4+	1+
JSBT118GO	No. 118G	Pack of 5	7.75	8.50

## No. 118A Jigsaw Blades H.S.S.

Pack of 5



- High quality jigsaw blades with bayonet mount to fit Festool, Bosch, AEG, Hitachi and Makita machines and many others with the same mount.
- Jigsaw blades No.118A, 50mm long with a pitch of 1.2mm, 20tpi.
- For cutting mild steel, aluminium and non-ferrous metals between 1.5mm and 4mm thick.
- Will also cut Acrylic between 1.5mm and 3mm thick.

CODE	Description	Unit	4+	1+
JSBT118AO	No. 118A	Pack of 5	7.50	8.25

## No. 118B Jigsaw Blades H.S.S.

Pack of 5



- High quality jigsaw blades with bayonet mount to fit Festool, Bosch, AEG, Hitachi and Makita machines and many others with the same mount.
- Jigsaw blades No.118B, 50mm long with a pitch of 2mm, 12tpi.
- For cutting mild steel between 3mm and 6mm thick, aluminium and non-ferrous metals between 3mm and 10mm thick.

CODE	Description	Unit	4+	1+
JSBT118BO	No. 118B	Pack of 5	7.50	8.25

## No. 127D Jigsaw Blades H.S.S.

Pack of 5



- High quality jigsaw blades with bayonet mount to fit Festool, Bosch, AEG, Hitachi and Makita machines and many others with the same mount.
- Jigsaw blades No.127D, 75mm long with a pitch of 3mm, 8tpi.
- For cutting mild steel 3-6mm, aluminium and non-ferrous 3-15mm, lead and tin below 20mm, plastics below 30mm.

CODE	Description	Unit	4+	1+
JSBT127DO	No. 127D	Pack of 5	8.75	9.50

## No. 118F Jigsaw Blades H.S.S.

Pack of 5



- High quality jigsaw blades with bayonet mount to fit Festool, Bosch, AEG, Hitachi and Makita machines and many others with the same mount.
- Bi-metal jigsaw blades No.118BF, 50mm long with a pitch of 2mm, 12tpi.
- For cutting mild steel between 3 and 6mm, aluminium and non-ferrous metals between 3mm and 10mm thick, wood with nails and Perspex.

CODE	Description	Unit	4+	1+
JSBT118BF	No. 118F	Pack of 5	11.25	12.25

## Olsen Scroll Saw Blades Plain End

Pack of 6



- The Olson PGT (Precision Ground Tooth) range of power fretsaw (or scrollsaw) blades are the ultimate quality, manufactured in the USA.
- Their razor sharp teeth cut faster, smoother and more accurately in both straight and curved cuts.
- Plain end blade.

CODE	Tpi	Width	Kerf	Unit	1+
OLS45502E	12tpi	.040"	.018"	Pack of 6	6.00
OLS45702E	10tpi	.046"	.018"	Pack of 6	6.00
OLS45902E	8tpi	.048"	.018"	Pack of 6	6.00

## Olsen Scroll Saw Blades Pinned

Pack of 6



- The Olson PGT (Precision Ground Tooth) range of power fretsaw (or scrollsaw) blades are the ultimate quality, manufactured in the USA.
- Their razor sharp teeth cut faster, smoother and more accurately in both straight and curved cuts.
- Pinned blade.

CODE	Tpi	Width	Kerf	Unit	1+
OLS40501P	20	.110"	.018"	Pack of 6	4.75
OLS41101P	15	.110"	.018"	Pack of 6	4.75
OLS41201P	10	.110"	.018"	Pack of 6	4.75
OLS42401P	18.5	.070"	.010"	Pack of 6	4.75

## Olsen Scroll Saw Blades Spiral Plain End

Pack of 12



- The Olson range of easy-to-use power fretsaw (or scrollsaw) spiral blades eliminates the need to rotate the workpiece, which effectively increases the throat depth.
- Available only as a plan end type.

CODE	Tpi	Kerf	Unit	1+
OLS46100S	46	.032"	Pack of 12	7.00
OLS46300S	41	.035"	Pack of 12	7.00
OLS46500S	36	.041"	Pack of 12	7.00

## Scroll Saw Blades

Pack of 10



- Replacement scroll saw (or power fretsaw) blades made in the UK.
- Standard 127mm pinned pattern to suit most power Scroll/Fretsaw machines.
- Available in 25tpi extra fine, 20tpi fine, 15tpi medium and 10tpi regular.

CODE	Description	Unit	10+	4+	1+
SSB025XFN	Extra Fine	Pack of 10	4.10	4.40	4.95
SSB020FNE	Fine	Pack of 10	4.00	4.50	4.75
SSB015MED	Medium	Pack of 10	4.00	4.50	4.75
SSB010REG	Regular	Pack of 10	4.00	4.50	4.75

## Hakansson Silco/Daikin Bandsaw Blades

Carbon steel bandsaws with a hard tooth edge and a flexible back. Suitable for general purpose sawing of wood, metal and plastics. The first line headed "Thin Gauge" is of blades .014" thick, which are suitable for smaller machines with a reduced diameter of drive wheel. The remaining blades have thicknesses of .025" to .035" depending on width.

**FOR SIZES NOT LISTED, PLEASE USE THE PRICING TABLE ON THE FOLLOWING PAGE**

### Thin Gauge

#### 56 1/8" Length (1425.5mm)

CODE	Width	TPI	Unit	4+	1+
XBS05618L14W06TH	1/4"	6	1	<b>10.25</b>	11.25
XBS05618L14W10TH	1/4"	10	1	<b>10.25</b>	11.25
XBS05618L38W06TH	3/8"	6	1	<b>10.75</b>	11.50
XBS05618L38W10TH	3/8"	10	1	<b>10.75</b>	11.50

#### 56 1/2" Length (1435mm)

CODE	Width	TPI	Unit	4+	1+
XBS05612L14W06TH	1/4"	6	1	<b>10.25</b>	11.25
XBS05612L14W10TH	1/4"	10	1	<b>10.25</b>	11.25
XBS05612L38W06TH	3/8"	6	1	<b>10.75</b>	11.50
XBS05612L38W10TH	3/8"	10	1	<b>10.75</b>	11.50

#### 59 1/2" Length (1511mm)

CODE	Width	TPI	Unit	4+	1+
XBS05912L14W06TH	1/4"	6	1	<b>10.25</b>	11.25
XBS05912L14W10TH	1/4"	10	1	<b>10.25</b>	11.25
XBS05912L38W06TH	3/8"	6	1	<b>10.75</b>	11.50
XBS05912L38W10TH	3/8"	10	1	<b>10.75</b>	11.50

#### 70 1/2" Length (1791mm)

CODE	Width	TPI	Unit	4+	1+
XBS07012L14W06TH	1/4"	6	1	<b>10.25</b>	11.25
XBS07012L14W10TH	1/4"	10	1	<b>10.25</b>	11.25
XBS07012L38W06TH	3/8"	6	1	<b>10.75</b>	11.50
XBS07012L38W10TH	3/8"	10	1	<b>10.75</b>	11.50
XBS07012L12W06TH	1/2"	6	1	<b>12.00</b>	13.00

### Hakansson Silco

#### 64 1/2" Length (1638mm)

CODE	Width	TPI	Unit	4+	1+
XBS06412L12W14T	1/2"	14	1	<b>11.50</b>	12.75
XBS06412L12W18T	1/2"	18	1	<b>11.50</b>	12.75

#### 73" Length (1866.9mm)

CODE	Width	TPI	Unit	4+	1+
XBS07300L14W06T	1/4"	6	1	<b>10.00</b>	10.75
XBS07300L14W10T	1/4"	10	1	<b>10.00</b>	10.75
XBS07300L38W06T	3/8"	6	1	<b>10.25</b>	11.25
XBS07300L38W10T	3/8"	10	1	<b>10.25</b>	11.25
XBS07300L12W06T	1/2"	6	1	<b>11.50</b>	12.75

#### 82 1/2" Length (2095.5mm)

CODE	Width	TPI	Unit	4+	1+
XBS08212L14W06T	1/4"	6	1	<b>10.00</b>	10.75
XBS08212L14W10T	1/4"	10	1	<b>10.00</b>	10.75
XBS08212L38W06T	3/8"	6	1	<b>10.25</b>	11.25
XBS08212L38W10T	3/8"	10	1	<b>10.25</b>	11.25
XBS08212L12W04T	1/2"	4	1	<b>11.50</b>	12.75
XBS08212L12W06T	1/2"	6	1	<b>11.50</b>	12.75



• Bi-Metal H.S.S. Blades available on request

### Hakansson Silco

#### 88" Length (2235mm)

CODE	Width	TPI	Unit	4+	1+
XBS08800L14W06T	1/4"	6	1	<b>10.00</b>	10.75
XBS08800L14W10T	1/4"	10	1	<b>10.00</b>	10.75
XBS08800L38W06T	3/8"	6	1	<b>10.25</b>	11.25
XBS08800L38W10T	3/8"	10	1	<b>10.25</b>	11.25
XBS08800L12W04T	1/2"	4	1	<b>11.50</b>	12.75
XBS08800L12W06T	1/2"	6	1	<b>11.50</b>	12.75

#### 90 1/2" Length (2299mm)

CODE	Width	TPI	Unit	4+	1+
XBS09012L14W06T	1/4"	6	1	<b>10.00</b>	10.75
XBS09012L14W10T	1/4"	10	1	<b>10.00</b>	10.75
XBS09012L38W06T	3/8"	6	1	<b>10.25</b>	11.25
XBS09012L38W10T	3/8"	10	1	<b>10.25</b>	11.25
XBS09012L12W04T	1/2"	4	1	<b>11.50</b>	12.75
XBS09012L12W06T	1/2"	6	1	<b>11.50</b>	12.75

#### 93" Length (2362mm)

CODE	Width	TPI	Unit	4+	1+
XBS09300L14W06T	1/4"	6	1	<b>10.00</b>	10.75
XBS09300L14W10T	1/4"	10	1	<b>10.00</b>	10.75
XBS09300L38W06T	3/8"	6	1	<b>10.25</b>	11.25
XBS09300L38W10T	3/8"	10	1	<b>10.25</b>	11.25
XBS09300L12W04T	1/2"	4	1	<b>11.50</b>	12.75
XBS09300L12W06T	1/2"	6	1	<b>11.50</b>	12.75

#### 102" Length (2591mm)

CODE	Width	TPI	Unit	4+	1+
XBS10200L14W06T	1/4"	6	1	<b>10.75</b>	11.50
XBS10200L14W10T	1/4"	10	1	<b>10.75</b>	11.50
XBS10200L38W06T	3/8"	6	1	<b>10.75</b>	11.75
XBS10200L38W10T	3/8"	10	1	<b>10.75</b>	11.75
XBS10200L12W04T	1/2"	4	1	<b>12.25</b>	13.25
XBS10200L12W06T	1/2"	6	1	<b>12.25</b>	13.25
XBS10200L58W04T	5/8"	4	1	<b>15.00</b>	16.25

#### 112" Length (2845mm)

CODE	Width	TPI	Unit	4+	1+
XBS11200L14W06T	1/4"	6	1	<b>11.25</b>	12.25
XBS11200L14W10T	1/4"	10	1	<b>11.25</b>	12.25
XBS11200L38W06T	3/8"	6	1	<b>11.50</b>	12.75
XBS11200L38W10T	3/8"	10	1	<b>11.50</b>	12.75
XBS11200L12W04T	1/2"	4	1	<b>13.25</b>	14.50
XBS11200L12W06T	1/2"	6	1	<b>13.25</b>	14.50
XBS11200L12W10T	1/2"	10	1	<b>13.25</b>	14.50
XBS11200L12W14T	1/2"	14	1	<b>13.25</b>	14.50
XBS11200L58W04T	5/8"	4	1	<b>15.75</b>	17.25
XBS11200L58W06T	5/8"	6	1	<b>15.75</b>	17.25
XBS11200L34W03T	3/4"	3	1	<b>16.75</b>	18.25

#### 114" Length (2895mm)

CODE	Width	TPI	Unit	4+	1+
XBS11400L14W06T	1/4"	6	1	<b>11.25</b>	12.25
XBS11400L14W10T	1/4"	10	1	<b>11.25</b>	12.25
XBS11400L38W06T	3/8"	6	1	<b>11.50</b>	12.75
XBS11400L38W10T	3/8"	10	1	<b>11.50</b>	12.75
XBS11400L12W04T	1/2"	4	1	<b>13.25</b>	14.50
XBS11400L12W06T	1/2"	6	1	<b>13.25</b>	14.50
XBS11400L12W10T	1/2"	10	1	<b>13.25</b>	14.50
XBS11400L12W14T	1/2"	14	1	<b>13.25</b>	14.50
XBS11400L58W04T	5/8"	4	1	<b>15.75</b>	17.25
XBS11400L58W06T	5/8"	6	1	<b>15.75</b>	17.25

#### 126" Length (3200mm)

CODE	Width	TPI	Unit	4+	1+
XBS12600L14W06T	1/4"	6	1	<b>12.00</b>	13.00
XBS12600L14W10T	1/4"	10	1	<b>12.00</b>	13.00
XBS12600L38W06T	3/8"	6	1	<b>13.00</b>	14.00
XBS12600L38W10T	3/8"	10	1	<b>13.00</b>	14.00
XBS12600L12W04T	1/2"	4	1	<b>14.00</b>	15.25
XBS12600L12W06T	1/2"	6	1	<b>14.00</b>	15.25
XBS12600L12W10T	1/2"	10	1	<b>14.00</b>	15.25
XBS12600L12W14T	1/2"	14	1	<b>14.00</b>	15.25
XBS12600L58W04T	5/8"	4	1	<b>16.75</b>	18.25

#### 135" Length (3429mm)

CODE	Width	TPI	Unit	4+	1+
XBS13500L38W06T	3/8"	6	1	<b>13.25</b>	14.50
XBS13500L38W10T	3/8"	10	1	<b>13.25</b>	14.50
XBS13500L12W04T	1/2"	4	1	<b>15.00</b>	16.25
XBS13500L12W06T	1/2"	6	1	<b>15.00</b>	16.25
XBS13500L12W10T	1/2"	10	1	<b>15.00</b>	16.25
XBS13500L12W14T	1/2"	14	1	<b>15.00</b>	16.25
XBS13500L58W04T	5/8"	4	1	<b>17.50</b>	19.00

#### 139" Length (3530mm)

CODE	Width	TPI	Unit	4+	1+
XBS13900L14W06T	1/4"	6	1	<b>12.25</b>	13.25
XBS13900L14W10T	1/4"	10	1	<b>12.25</b>	13.25
XBS13900L38W06T	3/8"	6	1	<b>13.25</b>	14.50
XBS13900L38W10T	3/8"	10	1	<b>13.25</b>	14.50
XBS13900L12W04T	1/2"	4	1	<b>15.00</b>	16.25
XBS13900L12W06T	1/2"	6	1	<b>15.00</b>	16.25
XBS13900L12W10T	1/2"	10	1	<b>15.00</b>	16.25
XBS13900L12W14T	1/2"	14	1	<b>15.00</b>	16.25
XBS13900L58W04T	5/8"	4	1	<b>17.50</b>	19.00
XBS13900L58W06T	5/8"	6	1	<b>17.50</b>	19.00
XBS13900L34W04T	3/4"	6	1	<b>18.75</b>	20.50

#### 142" Length (3607mm)

CODE	Width	TPI	Unit	4+	1+
XBS14200L38W06T	3/8"	6	1	<b>13.25</b>	14.50
XBS14200L12W04T	1/2"	4	1	<b>15.00</b>	16.25
XBS14200L12W06T	1/2"	6	1	<b>15.00</b>	16.25
XBS14200L12W10T	1/2"	10	1	<b>15.00</b>	16.25
XBS14200L34W04T	3/4"	4	1	<b>18.75</b>	20.50

#### 144" Length (3658mm)

CODE	Width	TPI	Unit	4+	1+
XBS14400L38W06T	3/8"	6	1	<b>13.25</b>	14.50
XBS14400L12W04T	1/2"	4	1	<b>15.00</b>	16.25
XBS14400L12W06T	1/2"	6	1	<b>15.00</b>	16.25
XBS14400L12W10T	1/2"	10	1	<b>15.00</b>	16.25
XBS14400L34W04T	3/4"	4	1	<b>18.75</b>	20.50

## Hakansson Silco/Daikin Bandsaw Blades

- Carbon steel bandsaws with a hard tooth edge and a flexible back. Suitable for general purpose sawing of wood, metal and plastics. The first line headed "Thin Gauge" is of blades .014" thick, which are suitable for smaller machines with a reduced diameter of drive wheel. The remaining blades have thicknesses of .025" to .035" depending on width.
- The price shown in the table is for one blade. If you require a size outside the range of the widths shown in the table, or need technical information, please telephone us. Due to the numerous combinations of bandsaw sizes we are unable to produce codes to cover these blades. When ordering, please state the exact length of blade in inches or millimetres, then refer to the table to select the desired width. Please also state the pitch required – the TPI available is shown at the bottom of the column.



**NOTE:** As these blades are made to order, they can not be returned or refunded if incorrectly ordered.

**SEE PREVIOUS PAGE FOR THE POPULAR BLADE PRICE TABLE**

### Hakansson/Daikin - 0.025" Thickness.

Width	Length	TPI	Unit	1+
1/4"	Up to 96" (8')	4, 6, 8, 10, 14, 18, 24	1	<b>10.75</b>
1/4"	Up to 108" (9')	4, 6, 8, 10, 14, 18, 24	1	<b>11.50</b>
1/4"	Up to 120" (10')	4, 6, 8, 10, 14, 18, 24	1	<b>12.00</b>
1/4"	Up to 132" (11')	4, 6, 8, 10, 14, 18, 24	1	<b>12.75</b>
1/4"	Up to 144" (12')	4, 6, 8, 10, 14, 18, 24	1	<b>13.50</b>
1/4"	Up to 156" (13')	4, 6, 8, 10, 14, 18, 24	1	<b>14.50</b>
1/4"	Up to 168" (14')	4, 6, 8, 10, 14, 18, 24	1	<b>12.00</b>
1/4"	Up to 180" (15')	4, 6, 8, 10, 14, 18, 24	1	<b>12.75</b>
1/4"	100ft Coil	4, 6, 8, 10, 14, 18, 24	Coil	<b>69.50</b>

Width	Length	TPI	Unit	1+
3/8"	Up to 96" (8')	3, 4, 6, 8, 10, 14, 18, 24	1	<b>11.00</b>
3/8"	Up to 108" (9')	3, 4, 6, 8, 10, 14, 18, 24	1	<b>11.75</b>
3/8"	Up to 120" (10')	3, 4, 6, 8, 10, 14, 18, 24	1	<b>12.25</b>
3/8"	Up to 132" (11')	3, 4, 6, 8, 10, 14, 18, 24	1	<b>13.50</b>
3/8"	Up to 144" (12')	3, 4, 6, 8, 10, 14, 18, 24	1	<b>13.75</b>
3/8"	Up to 156" (13')	3, 4, 6, 8, 10, 14, 18, 24	1	<b>14.50</b>
3/8"	Up to 168" (14')	3, 4, 6, 8, 10, 14, 18, 24	1	<b>15.50</b>
3/8"	Up to 180" (15')	3, 4, 6, 8, 10, 14, 18, 24	1	<b>16.50</b>
3/8"	100ft Coil	3, 4, 6, 8, 10, 14, 18, 24	Coil	<b>75.00</b>

Width	Length	TPI	Unit	1+
1/2"	Up to 96" (8')	3, 4, 6, 8, 10, 14, 18, 24	1	<b>12.25</b>
1/2"	Up to 108" (9')	3, 4, 6, 8, 10, 14, 18, 24	1	<b>12.75</b>
1/2"	Up to 120" (10')	3, 4, 6, 8, 10, 14, 18, 24	1	<b>13.75</b>
1/2"	Up to 132" (11')	3, 4, 6, 8, 10, 14, 18, 24	1	<b>14.50</b>
1/2"	Up to 144" (12')	3, 4, 6, 8, 10, 14, 18, 24	1	<b>15.50</b>
1/2"	Up to 156" (13')	3, 4, 6, 8, 10, 14, 18, 24	1	<b>16.00</b>
1/2"	Up to 168" (14')	3, 4, 6, 8, 10, 14, 18, 24	1	<b>16.75</b>
1/2"	Up to 180" (15')	3, 4, 6, 8, 10, 14, 18, 24	1	<b>17.50</b>
1/2"	100ft Coil	3, 4, 6, 8, 10, 14, 18, 24	Coil	<b>89.50</b>

### Thin Gauge - 0.014" thickness.

Width	Length	TPI	Unit	1+
1/4"	Up to 73"	4, 6, 10, 14, 24	1	<b>11.00</b>
3/8"	Up to 73"	4, 6, 10, 14, 24	1	<b>11.50</b>
1/2"	Up to 73"	4, 6, 14	1	<b>12.50</b>

### Hakansson/Daikin - 0.032" Thickness

Width	Length	TPI	Unit	1+
5/8"	Up to 96" (8')	3, 4, 6, 10, 14	1	<b>15.50</b>
5/8"	Up to 108" (9')	3, 4, 6, 10, 14	1	<b>15.50</b>
5/8"	Up to 120" (10')	3, 4, 6, 10, 14	1	<b>16.50</b>
5/8"	Up to 132" (11')	3, 4, 6, 10, 14	1	<b>17.25</b>
5/8"	Up to 144" (12')	3, 4, 6, 10, 14	1	<b>18.25</b>
5/8"	Up to 156" (13')	3, 4, 6, 10, 14	1	<b>19.00</b>
5/8"	Up to 168" (14')	3, 4, 6, 10, 14	1	<b>20.00</b>
5/8"	Up to 180" (15')	3, 4, 6, 10, 14	1	<b>21.00</b>
5/8"	100ft Coil	3, 4, 6, 10, 14	Coil	<b>105.00</b>

Width	Length	TPI	Unit	1+
3/4"	Up to 96" (8')	3, 4, 6, 10, 14	1	<b>15.25</b>
3/4"	Up to 108" (9')	3, 4, 6, 10, 14	1	<b>16.25</b>
3/4"	Up to 120" (10')	3, 4, 6, 10, 14	1	<b>17.25</b>
3/4"	Up to 132" (11')	3, 4, 6, 10, 14	1	<b>18.00</b>
3/4"	Up to 144" (12')	3, 4, 6, 10, 14	1	<b>19.00</b>
3/4"	Up to 156" (13')	3, 4, 6, 10, 14	1	<b>20.00</b>
3/4"	Up to 168" (14')	3, 4, 6, 10, 14	1	<b>21.00</b>
3/4"	Up to 180" (15')	3, 4, 6, 10, 14	1	<b>22.00</b>
3/4"	100ft Coil	3, 4, 6, 10, 14	Coil	<b>109.50</b>

Width	Length	TPI	Unit	1+
1"	Up to 96" (8')	2, 3, 4, 6, 8, 10, 14	1	<b>18.25</b>
1"	Up to 108" (9')	2, 3, 4, 6, 8, 10, 14	1	<b>19.50</b>
1"	Up to 120" (10')	2, 3, 4, 6, 8, 10, 14	1	<b>20.75</b>
1"	Up to 132" (11')	2, 3, 4, 6, 8, 10, 14	1	<b>21.75</b>
1"	Up to 144" (12')	2, 3, 4, 6, 8, 10, 14	1	<b>23.00</b>
1"	Up to 156" (13')	2, 3, 4, 6, 8, 10, 14	1	<b>24.25</b>
1"	Up to 168" (14')	2, 3, 4, 6, 8, 10, 14	1	<b>25.25</b>
1"	Up to 180" (15')	2, 3, 4, 6, 8, 10, 14	1	<b>26.50</b>
1"	100ft Coil	2, 3, 4, 6, 8, 10, 14	Coil	<b>135.00</b>

## Mortise Chisel and Bit



- These hollow square mortise chisels are precision manufactured, accurately ground to size and ready sharpened to ensure clean and fast cutting.
- Long window to allow easy ejection of waste wood.
- Suitable for use on most mortising machines.
- All chisels have a collar size of 13/16" (20.6mm).

CODE	Description	Unit	1+
<b>MCB140CMP</b>	1/4" x 40mm	1	<b>29.50</b>
<b>MCB380CMP</b>	3/8" x 60mm	1	<b>29.50</b>
<b>MCB120CMP</b>	1/2" x 60mm	1	<b>29.50</b>
<b>MCB580CMP</b>	5/8" x 85mm	1	<b>35.50</b>
<b>MCB340CMP</b>	3/4" x 85mm	1	<b>59.25</b>

## Mortise Chisel Sharpener



- The countersink sharpening tool is supplied with interchangeable pilots to suit 1/4", 5/16", 3/8" and 1/2" mortise chisels.
- The hexagon shank should ideally be used in a cordless drill at a slow speed.
- Supplied with a 6" x 2" diamond stone to remove any burrs.

CODE	Description	Unit	1+
<b>MCS143812</b>	Mortise Chisel Sharpener	1	<b>45.00</b>

## Hakansson M42 Bimetal Bandsaw Blades



These blades consist of an M42 high speed steel cutting edge electron-beam welded to a flexible steel back. This makes them considerably tougher than a carbon steel blade, suitable for cutting difficult materials, such as stainless steel, nickel and titanium, with longer blade life and at faster cutting speeds. They are a heavier gauge for larger machines and only give longer life if used with lubricant/coolant.



Please contact us for pricing.



## Viper Router Cutters

Viper® Router Bits consistently deliver clean, smooth, burn-free cuts.

All sizes are Imperial except where metric symbols are shown.

Strong, durable carbide with a micro-thin cutting edge

Consistently accurate sharpening results in very little to no runout

Smooth, full braze is key to keeping the tip of the bit attached to the body during heavy workloads

Turned from solid steel, not cast. Turned bodies are inherently stronger than cast bodies, capable of flexing further and returning to their original shape without breaking.



Computer-engineered shear and radial relief angles for clean chip removal and greater cutting efficiency, with less chipping and splintering

Full-body, anti-kick design prevents kickback; provides safer cutting

Anti-stick, heat-resistant coating provides safer, cleaner, quieter cutting action and longer cutting life

High-strength Stressproof steel prevents shanks from bending or breaking



## Viper Router Cutter Spiral Bits

### Double Flute Up-Cut - Solid Carbide

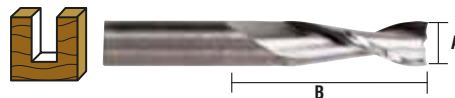

- The spiral on these bits pulls chips up out of the cut as you rout, allowing a faster feed rate than standard straight bits.
- Because of their efficient chip removal, up-cut spiral bits are good for mortise and tenons, grooving, dadoing and slotting.
- Up-cut spiral bits cut faster than down-cut spiral bits, but don't provide as smooth a finish.
- Designed for high production applications requiring fast feed rates.
- Used in portable, mounted and computer numerically controlled (CNC) routers. Overall length of profile 2 - 51mm. Overall length of profile 4 and 8 - 65mm.

CODE	Profile No.	Cutting Dia. (A)	Flute Length (B)	Shank Dia.	Unit	1+
VP1804SUC	2	1/8	1/2	1/4	1	19.50
VP1414SUC	4	1/4	1	1/4	1	29.50
VP0514SUC	8	5mm	19mm	1/4	1	25.95

## Viper Router Cutter Straight Bits

- Straight double flute router bits allow a clean, fast, burn-free plunge cut.
- They are designed for smooth balanced cutting with minimal vibration.

### Straight - 2 Flute



CODE	Profile No.	Cutting Dia. (A)	Flute Length (B)	Shank Dia.	Unit	1+
VP1414DFS	57	1/4	1	1/4	1	8.75
VP5164DFS	58	5/8	1	1/4	1	9.00
VP3814DFS	60	3/8	1	1/4	1	9.25
VP1214DFS	63	1/2	1	1/4	1	10.00
VP3414DFS	66	3/4	3/4	1/4	1	10.50
VP1402DFS	75	1/4	25/32	1/2	1	9.00
VP3802DFS	77	3/8	1	1/2	1	10.50
VP3812DFS	78	3/8	1 1/4	1/2	1	10.75
VP1212DFS	80	1/2	1	1/2	1	11.00
VP1202DFS	81	1/2	1 1/4	1/2	1	11.00
VP1222DFS	83	1/2	2	1/2	1	15.75
VP1242DFS	84	1/2	2 1/2	1/2	1	18.50
VP5802DFS	85	5/8	1 1/4	1/2	1	11.25
VP3402DFS	87	3/4	1 1/4	1/2	1	12.25
VP1002DFS	91	1	1 1/4	1/2	1	16.50
VP0064DFS	92	6mm	20mm	1/4	1	8.50
VP0094DFS	94	9mm	25mm	1/4	1	9.50
VP1014DFS	95	10mm	20mm	1/4	1	9.00
VP0124DFS	96	12mm	25mm	1/4	1	10.00
VP1514DFS	93	15mm	20mm	1/4	1	10.00
VP0182DFS	100	18mm	25mm	1/2	1	11.25
VP2012DFS	101	20mm	30mm	1/2	1	13.50

### Hinge Mortising



- Used to make mortises when the cut is started at the edge of the workpiece.
- The large center slot allows fast chip removal.
- Provides a smooth finish ideal for surfacing operations.

CODE	Profile No.	Cutting Dia. (A)	Flute Length (B)	Shank Dia.	Unit	1+
VP3404HMO	105	3/4	1/2	1/4	1	10.00

## Viper Router Cutter Spiral Bits

### Double Flute Down-Cut - Solid Carbide



- The spiral on these bits pushes the chips down into the cut, which requires the use of a slower feed rate and leaves a smoother cut edge.
- Ideal for plunge cutting.
- Down-cut spiral bits provide a smoother cut than up-cut spiral bits, but they cut more slowly.
- Used in portable, mounted and computer numerically controlled (CNC) routers.

CODE	Profile No.	Cutting Dia. (A)	Flute Length (B)	Shank Dia.	Unit	1+
VP1804SDC	16	1/8	1/2	1/4	1	19.50
VP1404SDC	17	1/4	3/4	1/4	1	29.50
VP0514SDC	21	5mm	20mm	1/4	1	25.95

## Viper Router Ball Nose Carbide Cutter



- A solid carbide cutter specifically manufactured for shaping and profiling.
- Ball nose cutter has a 1/8" radius (1/4" diameter) and a 25mm long cutting edge with a 1/4" shank.
- This is ideally suited for a CNC routing machine due to its long reach having an overall length of 64mm.
- Spiral up-cut ground cutting edge.
- For use in a hand or CNC router.

CODE	Profile No.	Cutting Dia. (A)	Flute Length (B)	Shank Dia.	Unit	1+
VP1404SBN	30	1/4	1	1/4	1	32.50

## Viper Router Engraving Carbide Cutter



- A solid carbide cutter specifically manufactured for engraving lettering and patterns.
- V-cutter with a 20 degree angle having a 17mm long cutting edge (overall length 50mm) and 1/4in shank.
- High quality solid carbide for excellent edge retention and durability.
- For use in hand or CNC router.

CODE	Profile No.	Cutting Angle (A)	Flute Length (B)	Shank Dia.	Unit	1+
VP1404SEG	40	20°	17mm	1/4	1	22.95

## Viper Router Cutter Laminate Trim & Pattern Bits

- Laminate trim bits are primarily used for making flush, trim and edge cuts in laminated surfaces without chipping or splintering. These bits can be used to cut any laminate thickness, and to cut all wood and composition materials.
- Pattern cutting bits have a bearing that is mounted on the shank, above the flutes. The bearing rides along the edge of the template or pattern, and the cutting edge of the bit routs the profile of the pattern on the workpiece.

### Pattern Bits with Top-Mounted Bearing



- Used for template and pattern cutting, plunge cutting and lettering signs.
- For cutting from both above and below the workpiece.

CODE	Profile No.	Cutting Dia. (A)	Flute Length (B)	Shank Dia.	Unit	1+
VP1254FTP	110	1/2	1/2	1/4	1	11.25
VP3402FTP	329	3/4	1	1/2	1	17.50

Replacement Bearings: **VP140B120** - 1/2"  
**VP140B580** - 5/8"  
**VP140B340** - 3/4" (1/4" Shank)

### Laminate Flush Trimming/Pattern Cutting Shearcut

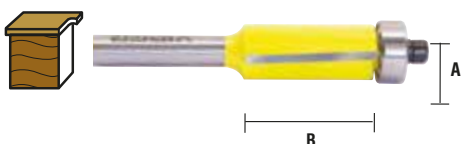

- For chatter-free production flush trimming.

CODE	Profile No.	Cutting Dia. (A)	Flute Length (B)	Shank Dia.	Unit	1+
VP1214LT3	139	1/2	1	1/4	1	14.25
VP1212LT3	143	1/2	1	1/2	1	14.25

Replacement Bearings: **VP316B120**

### 2 Flute Laminate Flush Trimming



- Provides fast, smooth, accurate trim cuts.

CODE	Profile No.	Cutting Dia. (A)	Flute Length (B)	Shank Dia.	Unit	1+
VP1214FLT	130	1/2	1	1/4	1	11.25
VP1224FLT	131	1/2	1 1/4	1/4	1	13.50
VP1222FLT	136	1/2	2	1/2	1	14.75

## Viper Router Cutter Grooving & Joinery Bits

- Grooving router bits, which cut deep or shallow grooves, are generally used for surface cutting work and are sometimes used on edges. These bits cut all wood and composition materials. Grooving bits do not have a pilot, so they are used with a fence, guide or template except when routing freehand. Project uses for these bits include sign making and creating decorative borders.
- Joinery bits are used to create joints, including dovetail, glue, tongue and groove, lock mitre and finger joints.

### Roundnose/Core Box

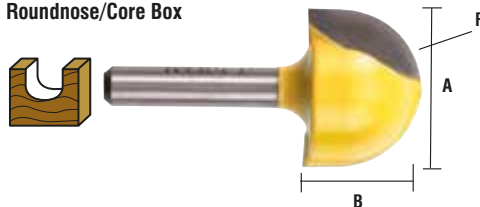

- Uses include fluting, grooving, veining, sign making and routing decorative accents.
- Also makes cove-style edges and joints when used with an edge guide or fence.

CODE	Profile No.	Radius (R)	Cutting Dia. (A)	Flute Length (B)	Shank Dia.	Unit	1+
VP1804RON	214	1/8	1/4	3/8	1/4	1	10.75
VP3164RON	213	3/16	3/8	3/8	1/4	1	11.50
VP1404RON	215	1/4	1/2	3/8	1/4	1	11.50
VP5164RON	216	5/16	5/8	1/2	1/4	1	12.25
VP3804RON	217	3/8	3/4	1/2	1/4	1	13.75
VP1402RON	221	1/4	1/2	3/8	1/2	1	15.00
VP5162RON	222	5/16	5/8	1/2	1/2	1	16.75
VP3802RON	223	3/8	3/4	1/2	1/2	1	20.25

### Beading



- For decorative grooving.
- Can also be used for edge forming.

CODE	Profile No.	Radius (R)	Cutting Dia. (A)	Flute Length (B)	Shank Dia.	Unit	1+
VP1804PBC	288	1/8	3/8	3/8	1/4	1	12.00

### Dovetail



- Used to make blind, through, sliding and variable space dovetail joints.

CODE	Profile No.	Cutting Dia. (A)	Flute Length (B)	Degree (C)	Shank Dia.	Unit	1+
VP1404DTA	194	1/4	3/8	7°	1/4	1	12.00
VP5164DTA	195	5/16	3/8	9°	1/4	1	12.25
VP3804DTA	196	3/8	3/8	8°	1/4	1	12.75
VP1204DTA	197	1/2	1/2	14°	1/2	1	13.50
VP1204DT1	914	1/2	7/8	10°	1/4	1	13.50
VP5804DTA	198	5/8	7/8	7°	1/4	1	13.75
VP3802DTA	203	3/8	3/8	9°	1/2	1	12.75
VP1202DTA	204	1/2	1/2	14°	1/2	1	13.50
VP1202DT1	915	1/2	7/8	8°	1/2	1	13.50
VP5802DTA	205	5/8	7/8	10°	1/2	1	13.75

### V-Groove



- Used for plunge cutting, routing veins, lettering and sign making; also chamfers when used with a fence.
- Available in 90° and 60° angles.

CODE	Profile No.	Cutting Dia. (A)	Flute Length (B)	Degree (C)	Shank Dia.	Unit	1+
VP1404VGR	228	1/4	5/16	90°	1/4	1	9.25
VP1204VGR	230	1/2	1/2	90°	1/4	1	11.50
VP7164VGR	241	7/16	9/16	60°	1/4	1	12.75
VP3402VGR	237	3/4	5/8	90°	1/2	1	15.75

### Lock Miter

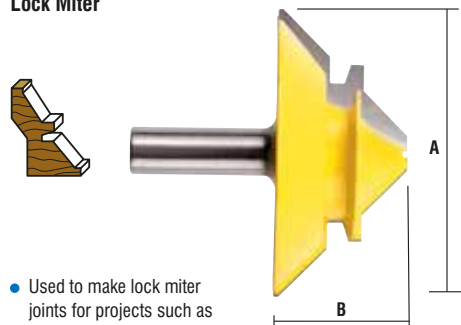

- Used to make lock miter joints for projects such as boxes, frames, beams and face frame corners.
- Makes strong glue joints.

CODE	Profile No.	Cutting Dia. (A)	Flute Length (B)	Shank Dia.	Unit	1+
VP2342LMC	440	2 3/4	1 1/4	1/2	1	40.75

### Tongue & Groove Assembly

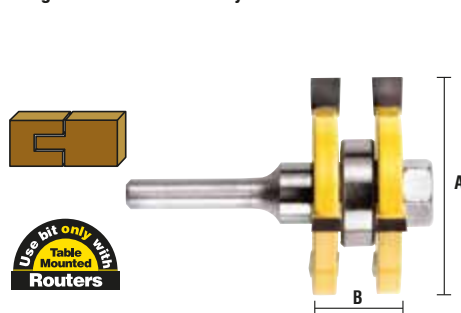

- Used to cut both tongues and grooves in 3/4" stock; remove the top cutter to make the matching groove cut.
- Use a fence to change the depth of the tongue and groove.
- As supplied, this assembly cuts 1/2" depth tongue and groove joints.

CODE	Profile No.	Cutting Dia. (A)	Flute Length (B)	Shank Dia.	Unit	1+
VP1342TGA	328	1 7/8	7/32	1/2	1	37.25

## Viper Multi-Depth Rabbeting Kit

- Edge Forming bits are used to shape the edges of the workpiece. These bits generally have a ball bearing pilot. You can change the cut width of the bit by changing the size of the bearing used.

### Cove

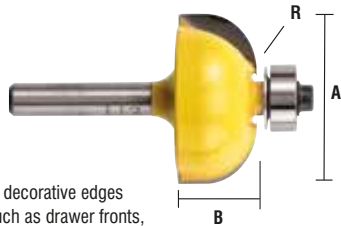

- Used to make decorative edges on projects such as drawer fronts, cabinet doors, moldings, decorative furniture pieces and trim.

CODE	Profile No.	Radius (R)	Cutting Dia. (A)	Flute Length (B)	Shank Dia.	Unit	1+
VP1404COV	341	1/4	1	1/2	1/4	1	17.50
VP3804COV	343	3/8	1 1/4	9/16	1/4	1	18.00
VP1402COV	350	1/4	1	1/2	1/2	1	17.50
VP3802COV	352	3/8	1 1/4	9/16	1/2	1	18.00

Replacement Bearings: **VP316B120**

### Cove & Bead

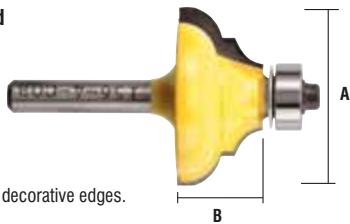

- For forming decorative edges.

CODE	Profile No.	Bead Radius	Cutting Dia. (A)	Flute Length (B)	Shank Dia.	Unit	1+
VP1142COB	403	3/16	1 1/4	9/16	1/2	1	23.50

Replacement Bearings: **VP316B120**

### Roundover

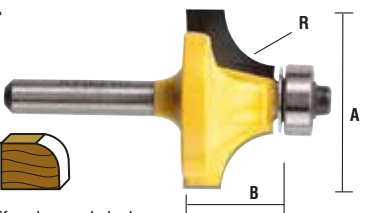

- Makes uniformly rounded edges.
- Flip the workpiece over and make a second pass to produce a half-round edge.
- Switch the bearing on the bit to a 3/8" bearing to make a beading profile.
- Project uses include tables, shelves, moldings, picture frames and stair treads.

CODE	Profile No.	Radius (R)	Cutting Dia. (A)	Flute Length (B)	Shank Dia.	Unit	1+
VP1804ROV	299	1/8	3/4	13/32	1/4	1	14.50
VP3164ROV	300	3/16	7/8	7/16	1/4	1	16.50
VP1404ROV	301	1/4	1	17/32	1/4	1	16.75
VP5164ROV	302	5/16	1 1/8	5/8	1/4	1	17.50
VP3804ROV	303	3/8	1 1/4	21/32	1/4	1	18.00
VP1204ROV	304	1/2	1 1/2	3/4	1/4	1	19.75
VP1402ROV	311	1/4	1	17/32	1/2	1	16.75
VP3802ROV	313	3/8	1 1/4	21/32	1/2	1	18.00
VP1202ROV	314	1/2	1 1/2	1 3/4	1/2	1	19.75
VP5802ROV	315	5/8	1 3/4	7/8	1/2	1	26.50
VP3402ROV	316	3/4	2	1	1/2	1	31.25
VP1012ROV	317	1	2 1/2	1 1/4	1/2	1	35.75

Replacement Bearings: **VP316B120**

## Chamfer

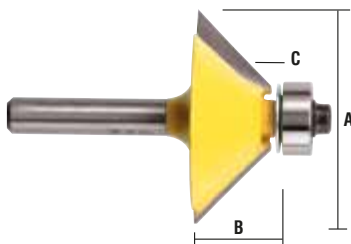

- For edge forming, edge gluing and laminate trimming.
- Adjust the height of the bit to make a variety of chamfers and bevels.

CODE	Profile No.	Cutting Dia. (A)	Flute Length (B)	Degree (C)	Shank Dia.	Unit	1+
VP1144CHM	366	1 1/4	3/8	45°	1/4	1	15.75
VP1122CHM	367	1 1/2	1/2	45°	1/2	1	16.75
VP2002CHM	371	2	3/4	45°	1/2	1	20.75

Replacement Bearing: **VP316B120**

## Ovolo/Beading

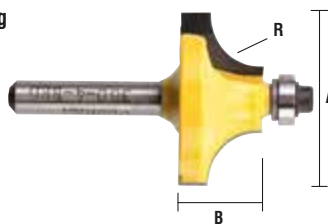

- Used to make decorative edges on projects such as furniture, drawer fronts, chair rails, casements, panelling, trim and cabinets.
- Switch the bearing on the bit to a 1/2" bearing to make a roundover profile.

CODE	Profile No.	Radius (R)	Cutting Dia. (A)	Flute Length (B)	Shank Dia.	Unit	1+
VP1804BED	321	1/8	3/4	13/32	1/4	1	14.50
VP3164BED	322	3/16	7/8	7/16	1/4	1	16.50
VP1404BED	323	1/4	1	17/32	1/4	1	16.75
VP5164BED	324	5/16	1 1/8	5/8	1/4	1	17.75
VP3804BED	325	3/8	1 1/4	21/32	1/4	1	18.00
VP1204BED	326	1/2	1 1/2	3/4	1/4	1	19.75
VP1402BED	332	1/4	1	17/32	1/2	1	16.75
VP3802BED	334	3/8	1 1/4	21/32	1/2	1	18.00
VP1202BED	335	1/2	1 1/2	1 3/4	1/2	1	19.75
VP5802BED	336	5/8	1 3/4	7/8	1/2	1	26.00
VP3402BED	337	3/4	2	1	1/2	1	31.25

Replacement Bearings: **VP316B380**

## Roman Ogee

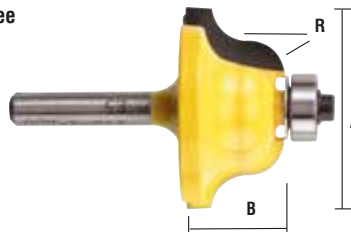

- Used to make decorative edges on projects such as moldings, furniture, signs and plaques.

CODE	Profile No.	Cutting Radius (R)	Cutting Dia. (A)	Flute Length (B)	Shank Dia.	Unit	1+
VP5324ROG	357	5/32	1 1/8	1/2	1/4	1	17.25
VP1404ROG	358	1/4	1 1/2	3/4	1/4	1	21.50
VP5322ROG	361	5/32	1 1/8	1/2	1/2	1	17.25
VP1402ROG	362	1/4	1 1/2	3/4	1/2	1	21.75

Replacement Bearings: **VP316B120**

## Multi-Profile Molding Maker

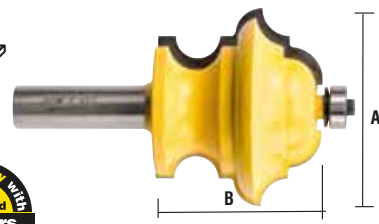

- Makes over 40 different profiles and standard moulding designs.
- Adjust the cutter height and fence position to change profiles.

CODE	Profile No.	Cutting Dia. (A)	Flute Length (B)	Shank Dia.	Unit	1+
VP1122MPC	438	1 1/2	1 1/8	1/2	1	31.25
VP2142MPC	439	2 1/4	1 7/8	1/2	1	42.25

## Edge Beading

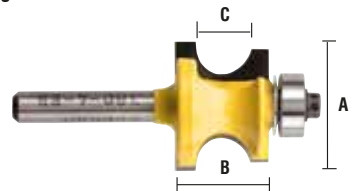

- Used for edge grooving.
- Project uses include forming decorative beads on the edges of projects such as moldings and picture frames.

CODE	Profile No.	Cutting Dia. (A)	Flute Length (B)	Bead Dia. (C)	Shank Dia.	Unit	1+
VP1204EBC	449	1 1/8	7/8	1/2	1/4	1	20.50
VP1404EBC	450	7/8	5/8	1/4	1/4	1	19.00
VP1202EBC	454	1 1/8	7/8	1/2	1/2	1	20.50
VP3802EBC	456	1	3/4	3/8	1/2	1	20.25
VP1402EBC	455	7/8	5/8	1/4	1/2	1	19.00

## Shank Mounted Bearing Guided Intumescent Recesser

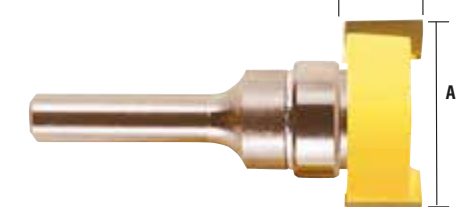

- For either frame or door applications, with standard intumescent strip.
- Neatly cuts 4mm deep grooves on doors or frames to accept Intumescent Strip which enables the formation of effective barriers to both fire and smoke.
- Available in two sizes to suit either 10 or 15mm intumescent strip.

CODE	Profile No.	Cutting Dia. (A)	Flute Length (B)	Shank Dia.	Unit	1+
VP1514ITR	501	24mm	15mm	1/4	1	22.25
VP1012ITR	502	40mm	10mm	1/2	1	27.00
VP1512ITR	503	40mm	15mm	1/2	1	29.00

## Viper Router Cutter Edge Forming Bit

Multi-Depth Rabbeting Kit



- Allows you to use one bit to cut rabbets with a depth of 1/8", 1/4", 5/16", 3/8", 7/16" and 1/2".
- Kit contains one viper rabbeting bit, six bearings and an Allen wrench.

CODE	Cutting Dia. (A)	Flute Length (B)	Shank Dia.	Unit	1+
VP6PCRAB2	1 1/2	3/4	1/2	1	<b>48.25</b>

Replacement Bearing: **VP316B120**

## Viper Router Arbors for Trimmers and Slot Cutters



- The 5/16" diameter arbor for trimmers and slot cutters.

CODE	Profile No.	Spindle Diameter	Shank Diameter	Unit	1+
VP5162ARP	593	5/16	1/2	1	<b>9.00</b>

## Bearings



- Replacement bearings.
- Also used to adjust the depth of slot cutters.

CODE	No.	Outside Dia.	Width	Inside Dia.	Unit	1+
VP316B380	601	3/8	1/8	3/16	1	<b>2.75</b>
VP316B120	602	1/2	5mm	3/16	1	<b>2.75</b>
VP140B120	607	1/2	3/16	1/4	1	<b>2.75</b>
VP140B580	603	5/8	5mm	1/4	1	<b>2.75</b>
VP140B340	604	3/4	9/32	1/4	1	<b>4.95</b>

## Viper Router Cutter 3-Wing Slot Cutters

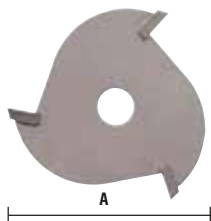

- Used to make rabbets, dados, lap joints, tongue and groove joints.

CODE	Profile No.	Cutting Dia.	Kerf. Thick (in.)	Hole Dia.	Unit	1+
VP1160SL3	505	2	1/16" (1.6mm)	5/16	1	<b>11.25</b>
VP3320SL3	508	2	3/32" (2.4mm)	5/16	1	<b>11.25</b>
VP1800SL3	509	2	1/8" (3.2mm)	5/16	1	<b>11.25</b>
VP5320SL3	510	2	5/32" (4mm)	5/16	1	<b>11.25</b>
VP3160SL3	511	2	3/16" (4.75mm)	5/16	1	<b>11.25</b>
VP1400SL3	512	2	1/4" (6.4mm)	5/16	1	<b>11.25</b>

## TCT Router Cutter Set 12 Piece



- Tungsten carbide tipped router cutter assortment.
- Contains: Straights 8 and 16mm, Core Box R6mm, Grooving 15mm, Dovetail 16mm, Flush Trim 19mm, Chamfer 27mm, Roundover R6 and R10mm, Cove R6 and R10mm, Roman Ogee R6.5mm.
- 1/4" shank.

CODE	Description	Unit	2+	1+
RCS120SET	12 Piece Set	1	<b>29.95</b>	34.95

## Masonry Drills Single or 5 Piece Set



- Roll formed and treated body with a heavy-duty Tungsten Carbide tip.
- Fast spiral for quick waste removal.
- 5 piece set contains:- 5, 5.5, 6, 6.5 and 7mm.

CODE	Description	Unit	4+	1+
MSD005DRL	5mm x 85mm	1	<b>1.50</b>	2.00
MSD055DRL	5.5mm x 100mm	1	<b>1.50</b>	2.00
MSD006DRL	6mm x 100mm	1	<b>1.75</b>	2.25
MSD065DRL	6.5mm x 100mm	1	<b>2.25</b>	2.75
MSD007DRL	7mm x 100mm	1	<b>2.25</b>	2.75
MSD500SET	Masonry Bit Set	5 Piece	<b>12.50</b>	

## SDS Masonry Drills Single or 5 Piece Set



- SDS Plus system enables faster changing of drills.
- Heavy-duty tungsten carbide tip.
- 5pc set contains - 5.5, 6, 7 and 8mm
- Working length 100mm.

CODE	Description	Unit	4+	1+
SDS055DRL	5.5mm	1	<b>3.25</b>	3.95
SDS006DRL	6mm	1	<b>3.00</b>	4.00
SDS007DRL	7mm	1	<b>3.50</b>	4.50
SDS008DRL	8mm	1	<b>3.95</b>	4.95
SDS400SET	Masonry Drill Set	5 Piece	<b>15.95</b>	

## Glass Drill Set 4 Piece



- Four piece set of drills suitable for clean drilling of glass and tiles.
- Tungsten carbide tipped spear shaped point for accurate positioning.

CODE	Description	Unit	1+
GD3568SET	3, 5, 6 and 8mm Set	4 Piece	<b>5.75</b>

## Masonry Drill Set 8 Piece



- High quality masonry drill set with carbide tips.
- Sizes Included:- 3, 4, 5, 6, 7, 8, 9 and 10mm.
- For use in brick, block and concrete.

CODE	Description	Unit	2+	1+
MSD800SET	Drill Set	8 Piece	<b>3.95</b>	4.75



# Machines & Power Tools

---

**Power Tools**  
206-210

---

**3D Printers**  
211

---

**Laser Cutters, Cutting Plotters  
Scanners & Engravers**  
212-215

---

**CNC Equipment**  
217

---

**Extraction**  
218-222

---

**Plastics Machinery**  
223-227

---

**Workshop Machinery**  
228-246

TILGEAR

2023/24 ISSUE 58

## Bosch Pro Cordless Combi Drill 18V 2 x 1.5Ah Batteries



- Bosch Pro Range GSB 18V Combi Drill/Driver with 13mm keyless chuck and LED light.
- 2 speed with variable trigger.
- 2 x 1.5Ah Li-Ion batteries with charge level indicators.
- Supplied with charger and carry case.

CODE	Description	Unit	4+	1+
BSH182CMB	18V Combi	1	115.00	125.00

## Bosch Cordless Drill Easy Drill 18V-40



- Cordless 18V Drill/Driver, compact and ergonomic for easy use.
- Two speed gearbox, 0 – 430 / 1,630 rpm.
- 13mm keyless chuck with 20 torque settings.
- 18V x 2.0Ah battery and charger.

CODE	Size	Unit	2+	1+
BSH180EDR	18V	1	67.95	69.95

## Bosch Corded Drill Impact 700



- Very low weight and compact design make this tool exceptionally easy to handle.
- Keyless chuck with Press&Lock – easy bit changing because the drill spindle is locked at the press of a button.
- Electronic speed preselection and control using setting wheel and trigger switch with forward/reverse rotation.
- Screw driving/Drilling/Impact drilling function switch for material-specific work.
- Powerful 700 watt motor.

CODE	Size	Unit	1+
BSH700HDR	700W	1	67.50

## Bosch Jigsaw PST 700 E



- Compact size, variable speed and low weight ensures perfect control.
- Bosch SDS ensures effortless and safe saw blade changes within seconds – without the need for additional tools.
- Switchable air blast function ensures a clear view of the cutting line at all times.
- Adjustable angle sole plate and dust extraction port.
- 500W, 70mm cutting depth.

CODE	Size	Unit	1+
BSH700PST	500W	1	59.95

## Bosch Orbital Sander PSS 200 A



- A low vibration sander for high-quality surface finishes over large areas.
- Velcro-type fastening for fast and convenient sanding sheet changes.
- Built-in dust extraction element sucks the dust directly into the Microfilter Box, which comes complete with the tool.
- Dust extraction port for connection to an extractor.
- Powerful 200 watt motor and 92 x 182 mm sanding surface.

CODE	Size	Unit	1+
BSH200PSS	200W	1	47.50

## Bosch Random Orbit Sander PEX 220 A



- A random orbit sander for producing an exceptionally fine, high-performance sanding finish and also functions as an effective polisher.
- Velcro-type fastening for fast and convenient sanding sheet changes.
- Built-in dust extraction element sucks the dust directly into the Microfilter Box, which comes complete with the tool.
- Dust extraction port for connection to an extractor.
- 220W, 125mm disc.

CODE	Size	Unit	1+
BSH220PEX	220W	1	50.50

## Bosch Router POF 1200 AE



- Electronic variable speed control.
- Spindle lock for quick cutter change.
- Bosch SDS system enables easy, tool-free insertion of the template guide.
- Supplied with collets 1/4", 6mm and 8mm, chip guard and dust extraction port.
- Powerful 1200 watt motor.

CODE	Size	Unit	1+
BSH120POF	1200W	1	92.50

## Bosch Multi Tool PMF 220 CE



- Continuously variable preselection of the oscillation rate enables you to gear your work towards the material and application.
- Convenient, effortless changing of all accessories thanks to magnetic tool holder with universal screw.
- Precise and gentle plunge cutting due to rounded cutting edges of the plunge cut saw blades with Curved-Tec.
- Supplied with saw blades, sanding plate and sheets, and depth stop.
- 220W Constant Electronic.

CODE	Size	Unit	1+
BSH220PMF	220W	1	75.00

## Bosch Heat Gun Universal Heat 600



- Three temperature settings (50/300/600°C) and a removable heat shield for versatility.
- Heating element (1800W) provides fast heat-up time and even heat distribution.
- On-off switch with three steps for selecting temperature and airflow options (200/300/500 l/min).
- Back of gun has a slip-resistant rubberised surface for standing.
- Variety of task-specific nozzles.

CODE	Size	Unit	1+
BSH600HGN	600W	1	45.00

## Makita Circular Saw No.HS7601



- Dust extraction facility.
- Powerful motor 1200W
- Blade diameter 190mm.
- Depth of cut @ 90° - 66mm, 45° - 46mm.

CODE	Description	Voltage	Unit	1+
MAK760110	Circular Saw	110	1	<a href="#">See Website</a>

## Makita Orbital Action Jigsaw No.4329



- Variable speed control, 240V.
- Dust extraction facility.
- Chip deflector.
- Sturdy adjustable base.
- Max in steel - 6mm.
- Input wattage - 450W.
- Max in wood - 65mm.

CODE	Description	Unit	Unit	1+
MAK4329JS	Orbital Action Jigsaw	1		<a href="#">See Website</a>

## Makita 1/2" Router No.RP2301FC



- 1/2" Collet Capacity.
- 70mm plunge capacity.
- 2100 Watt.
- Speed 9000 - 22000 rpm.
- Weight 6.1kg.

CODE	Description	Voltage	Unit	1+
MAK2301RT	1/2" Router	240	1	<a href="#">See Website</a>
MAK230110	1/2" Router	110	1	<a href="#">See Website</a>

## Makita 1/4" Router No.RP0900X



- 1/4" or 3/8" collet capacity.
- 35mm plunge capacity.
- 1200 Watt.
- Speed 27000rpm.

CODE	Description	Voltage	Unit	1+
MAK900XRT	1/4" Router	240	1	<a href="#">See Website</a>
MAK900110	1/4" Router	110	1	<a href="#">See Website</a>

**Makita**

**New Cordless Range**  
Please contact us for  
your requirements  
[www.tilgear.co.uk](http://www.tilgear.co.uk)

## Makita Biscuit Jointer PJ 7000



- Motor power 700W.
- Rotatable dust nozzle for easy connection to dust extraction.
- 6 preset cutting depths and shaft lock for easy blade change.
- Angle adjustable fence with positive stop at 0°, 45° and 90°.
- Blade diameter 100mm x thickness 4mm.

CODE	Description	Voltage	Unit	1+
MAK7000BJ	Biscuit Jointer	240	1	<a href="#">See Website</a>
MAK700110	Biscuit Jointer	110	1	<a href="#">See Website</a>

## Makita Orbital Action Jigsaw No.4350



- Quick release tool-less blade change.
- 720W variable electronic speed control.
- Sturdy adjustable cutting.
- Made in UK.

CODE	Description	Voltage	Unit	1+
MAK4350JS	Jigsaw - 4350	240	1	<a href="#">See Website</a>
MAK435110	Jigsaw - 4350	110	1	<a href="#">See Website</a>

## Makita Palm Sander No.4555



- 200 Watt.
- 114 x 140mm sheet size.
- Dust bag.

CODE	Description	Voltage	Unit	1+
MAK4555PS	Palm Sander	240	1	<a href="#">See Website</a>
MAK455110	Palm Sander	110	1	<a href="#">See Website</a>

## Bosch Grinder GWS-7115



- 670 Watt.
- Single speed.
- Spindle lock.

CODE	Description	Voltage	Unit	1+
BSH7115AG	Grinder	220v	1	<a href="#">See Website</a>
BSH711110	Grinder	110v	1	<a href="#">See Website</a>

## Dewalt DCK211D2T XR Twin Pack 10.8 Volt



- Twin pack contains a Compact Drill 12V, Impact Driver 12V, Charger and 2 x 12V 2.0Ah Batteries.
- Drill has a 10mm single sleeve keyless chuck with automatic spindle lock for quick and easy bit change.
- Impact Driver has 1/4" bit holder and no load speed of 2450/min.
- Both feature all metal gearing for efficient power transmission and long tool life.
- Supplied in a TSTAK™ V Toolbox.

CODE	Description	Unit	1+
DEW211SET	Combo 12V	Set	<a href="#">See Website</a>

## Dewalt DCD996P2 XR 18V Brushless Combi Drill



- Brushless Motor Premium Hammer Drill Driver has a tough 3 speed all metal transmission.
- Electronic clutch has an 11 position adjustable torque control.
- 13mm ratcheting keyless chuck with automatic spindle lock.
- Supplied XR Charger, Bit Holder, Side Handle, and Heavy-Duty Kit Box.
- 2 battery 18V 5.0Ah.

CODE	Description	Unit	1+
DEW996HDR	18V/5.0Ah	1	<a href="#">See Website</a>

## Dewalt DW331K Jigsaw



- Powerful 700 Watt motor with variable speed - up to 3100 strokes per minute.
- Quick and easy patented keyless blade change system accepts T - shank blades.
- Soft start, 4-position pendulum action and dust blower.
- Full wave electronic speed control with feedback.
- Tapered saw blade roller to control blade deflection.

CODE	Description	Unit	1+
DEW331240	DW331K – 240V	1	<a href="#">See Website</a>
DEW331110	DW331K – 110V	1	<a href="#">See Website</a>

## Dewalt DCF887D2 18V XR Impact Driver



- High power, brushless motor, up to 205Nm of torque.
- 3 motor speeds and torque settings.
- Super lightweight and compact design.
- Supplied with Multi-Voltage XR Charger, Magnetic Bit Holder, Belt Hook and Heavy-Duty Kit Box.
- 2 battery 18V 2.0Ah.

CODE	Description	Unit	1+
DEW887IDR	18V/2.0Ah	1	<a href="#">See Website</a>

Please contact us for your  
**DeWalt requirements**  
[www.tilgear.co.uk](http://www.tilgear.co.uk)

## Dewalt D26500K 4mm Planer



- A powerful planer that copes with a maximum depth of cut.
- Left and right chip ejection and 3 chamfering grooves.
- Front handle depth control in clearly marked 0.1 mm steps.
- Tungsten carbide tipped reversible blades, parallel fences, rebate depth guide and extraction spout.
- Heavy duty carrying case, chip deflector and high capacity collapsible collection container.

CODE	Description	Unit	1+
DEW265240	D26500K – 240V	1	<a href="#">See Website</a>
DEW265110	D26500K – 110V	1	<a href="#">See Website</a>

## Dewalt DCD795M1 18V XR Hammer Drill Driver



- Brushless motor delivers up to 57% more run time.
- High speed transmission delivers 2-speed settings (0-600/0-2,000 RPM).
- Metal keyless 13mm chuck.
- Supplied with Multi-Voltage XR Charger, Magnetic Bit Holder, Belt Hook and Heavy-Duty Kit Box.
- 1 battery 18V 4.0Ah.

CODE	Description	Unit	1+
DEW795HDR	18V/4.0Ah	1	<a href="#">See Website</a>

## Dewalt DW625EK Router 1/2" Collet

- Router with 2300 watts of power to tackle the toughest materials and applications.
- One touch plunge lock with 80mm plunge capacity and variable speed.
- Improved Airlock compatible dust extraction port gives a cleaner safer work environment.
- The DWE625 shares the same base as the DW625 so existing bushes and attachments are compatible.



CODE	Description	Unit	1+
DEW625240	DWE625KT-240V	1	<a href="#">See Website</a>
DEW625110	DWE625KT-110V	1	<a href="#">See Website</a>

## Dewalt DW682K Biscuit Jointer



- Pre-set cutting depths for 0, 10 and 20 biscuit sizes.
- Additional fine adjustment for ultimate accuracy.
- Grooving setting with up to 20mm depth of cut.
- Spindle lock mechanism for quick and easy blade changes.
- Tungsten carbide tipped grooving cutter, collection bag, extraction attachment and case.

CODE	Description	Unit	1+
DEW682240	DW682 – 240V	1	<a href="#">See Website</a>
DEW682110	DW682 – 110V	1	<a href="#">See Website</a>



## Dewalt 1/4 Sheet Palm Sander



- Counterweight design and rubber texture reduces vibration.
- Rubber dust boot to protect switch and 100% sealed ball-bearing construction provides longer life.
- Hook & Loop plate and paper clamps provided for both velcro and conventional abrasives.
- Integral dust collector or locking dust-port system for direct connection to dust collectors.
- Motor 230W with a 180 x 115mm base plate.

CODE	Description	Unit	1+
DEW641240	240V	1	<a href="#">See Website</a>
DEW641110	110V	1	<a href="#">See Website</a>

## Dewalt D26411 1800W Heatgun



- Durable design with added protection for the heating element. Two air flows to maximise control.
- Large stable support stand to ensure safety in stationary applications.
- Cone nozzle and fish tail surface nozzles.

CODE	Description	Unit	1+
DEW264HGN	1800W	1	<a href="#">See Website</a>

## Dewalt DW03050 Laser Distance Measurer



- Calculates area and volume with automatic calculations that make job estimates quick and easy.
- Indirect height measurement uses Pythagoras to measure distances even when point A and/or point B isn't accessible for linear measurement.
- The laser distance measure features a memory unit that stores the last 5 measurements.
- Operating Range of 50m to an accuracy of +/- 1.5mm.
- Durable case which is IP65 water/debris resistant and powered by 2 x AAA batteries.

CODE	Description	Unit	1+
DEW305LDM	DW03050	1	<a href="#">See Website</a>

## Dewalt DWS774 XPS Sliding Mitre Saw



- Head can be locked for trim applications and ease of transportation.
- Integrated positive mitre stops at 15°, 22.5°, 30°, 45° and quick release mitre mechanism up to 50°.
- XPS shadow line cut indicator for accurate alignment of the blade.
- Compact Internal rail design for huge cutting capacity.
- 1400W Saw supplied with: 1 x 216mm CT Blade, 2 x Bench Mounting Bolts, 1 x Blade Spanner and 1 x Material Camp.

CODE	Description	Unit	1+
DEW774240	DWS774 – 240V	1	<a href="#">See Website</a>
DEW774110	DWS774 – 110V	1	<a href="#">See Website</a>

## Dewalt DWS780 Sliding Mitre Saw



- Outstanding cutting performance up to 110 X 303 mm.
- Shadow line cut indicator for accuracy.
- Cam action mitre lock function makes mitre setting faster - between 0° - 50° left and 0° - 60° right.
- Large dual sliding fences gives maximum support.
- Bronze linear guides for precision cutting.

CODE	Description	Unit	1+
DEW780240	DWS780 – 240V	1	<a href="#">See Website</a>
DEW780110	DWS780 – 110V	1	<a href="#">See Website</a>

## Dewalt DWS727 XPS Sliding Compound Mitre Saw



- Double bevel sliding mitre saw with cut line indicator for high accuracy.
- Cam action, mitre lock function, makes mitre setting faster and easier, allowing the user to quickly adjust angles between 0-50 left and 0-60 right.
- Fitted with a large dual sliding fence that provides maximum support when cutting larger materials.
- Input Power: 1,675W, No Load Speed: 4,300/min. Blade: 250 x 30mm Bore.
- Capacity (mm): 90 /90 305 x 77mm, 90 /45 305 x 50mm, 45 /90 210 x 77mm, 45 /45 210 x 50mm

CODE	Description	Unit	1+
DEW727240	230 Volt	1	<a href="#">See Website</a>
DEW727110	110 Volt	1	<a href="#">See Website</a>

## DeWalt DCK699M3T XR Kit 18V Li-Ion 6 Piece



- The Dewalt DCK699M3T XR 6 piece kit contains the following:
  - 1 x 18 Volt Brushless Compact Hammer Drill - 2 speed, 13mm chuck.
  - 1 x 18 Volt Brushless Impact Driver.
  - 1 x 18 Volt SDS Hammer Drill with rotation stop mode.
  - 1 x 18 Volt Jigsaw - keyless blade change and variable speed.
  - 1 x 18 Volt Circular Saw with cutting depth of 55mm.
  - 1 x 18 Volt LED Pivot Light with ratchet lock.
  - 1 x Multi-Voltage Universal Charger.
  - 3 x 18 Volt 4.0Ah XR Li-Ion Batteries.
  - 2 x TSTAK™ Deep Toolboxes.

CODE	Description	Unit	1+
DEW250KIT	DCK699M3T	1	<a href="#">See Website</a>

## Einhell Cordless Drill Driver 18V



- Powerful 18V cordless drill with a 1.5Ah Li-Ion battery.
- Variable speed for powerful screwing and fast drilling, with 21 torque settings.
- Keyless chuck 0-10mm for easy tool change.
- LED lamp to illuminate the working area. Includes a 1 hour charger and 1x 1.5 Ah Li-Ion battery.

CODE	Description	Unit	2+	1+
EIN018CDD	18V/1.5Ah	1	56.25	61.75

## Compact Rotary Tool



- Powerful 230V, 135 watt motor.
- Variable speeds from 15,000 to 35,000 rpm.
- Collet chuck capacity: 2.4mm (3/32") and 3.2mm (1/8").
- Push button spindle lock for tool changing.
- Supplied in a convenient tool case.

CODE	Description	Unit	1+
HSR320CMP	Compact Rotary Tool	1	38.95

## Dremel Fortiflex Hanging Motor and Shaft



- Powerful 300W/230V variable high speed motor (No load speed 0 - 20.000 1/min) also provides high torque at low speeds.
- Heavy duty flexible shaft 1m includes a patented bearing system and attaches to a precision hand piece.
- Variable speed foot pedal allows you to match the speed with the application, hands-free interchangeable hand piece is compatible with other flex shaft tools.

CODE	Description	Unit	1+
DRM910FHM	Fortiflex	1	250.00

Please contact us for your Einhell requirements  
[www.tilgear.co.uk](http://www.tilgear.co.uk)

## Dremel 3000 Multi-Tool Kit 240V



- The 3000 is Dremel's popular all-round Multi-tool, updated with new features.
- Innovative EZ Twist Nose Cap: no wrench required for changing accessories.
- Variable speed - 10.000 - 33.000 RPM.
- Product includes: Dremel 3000, 15 high quality Dremel Accessories, instruction manual, soft bag.
- 130W 240V motor for optimal performance.

CODE	Description	Unit	1+
DRM315SET	3000	1	49.95

## Einhell Heat Gun 2000W



- Dual power heat gun producing temperatures of 350/500°C.
- Air Flow: 300/500 l/min.
- Supplied with colour rasper, fishtail nozzle, reflector nozzle, deflector nozzle, cone nozzle and carry case.
- 2000W 240V.

CODE	Description	Unit	1+
EIN202HGN	Heat Gun	1	27.00

## Dremel 8220 Multi-Tool Kit 12V Li-Ion



- High performance 8220 Li-Ion cordless Multi-Tool with a separate on/off switch to prevent accidentally activation.
- Innovative EZ Twist Nose Cap: no wrench required.
- Variable speed - 5.000 - 35.000 RPM with a motor brake that stops the unit immediately.
- Includes: 45 accessories, detailer's grip attachment, shaping platform, charger, soft bag, 1 x 2.0Ah Li-Ion battery.

CODE	Description	Unit	1+
DRM822SET	8220/45	1	125.00

### MACHINES & POWER TOOLS

## Trend Routers available - please enquire

### Trend 850w Variable Speed Router



### Trend Router T5 230V



### Trend Router T10 230V



## MakerBot Sketch 3D Printer Classroom Bundle



- Classroom bundle of two Sketch Printers includes 12 licenses, two for teachers and ten for students and MakerBot Certification program, MakerBot Cloud™, 6 MakerBot PLA Spools, 4 Build Plates, 2 Spatulas and 2 Snips.
- The software is integrated with TinkerCad, Autodesk Fusion 360, and Onshape. Over 600 lesson plans are currently available through Thingiverse Education for grade levels and common subject curriculum.
- Heated build plate for secure, successful printing and a flexible surface to make removing finished prints a breeze.
- Enclosed chamber with particulate filter so you can place your printers anywhere in the classroom without worrying about curious hands and print with peace of mind with a particulate filter installed in each printer. Build volume 150mm x 150mm x 150mm.

CODE	Description	Unit	1+
MBT202SET	Sketch Bundle	1	<b>1950.00</b>

## UltiMaker Sketch Large 3D Printer Classroom Bundle



- Classroom bundle of two Sketch Printers includes 12 licenses, two for teachers and ten for students and MakerBot Certification program, MakerBot Cloud™, 6 MakerBot PLA Spools, 4 Build Plates, 2 Spatulas and 2 Snips.
- The software is integrated with TinkerCad, Autodesk Fusion 360, and Onshape. Over 600 lesson plans are currently available through Thingiverse Education for grade levels and common subject curriculum.
- Heated build plate for secure, successful printing and a flexible surface to make removing finished prints a breeze.
- Enclosed chamber with particulate filter so you can place your printers anywhere in the classroom without worrying about curious hands and print with peace of mind with a particulate filter installed in each printer
- Build volume 220 x 200 x 250mm.

CODE	Description	Unit	1+
MBT404SET	Classroom Bundle	1	<b>3895.00</b>

## MakerBot Sketch Filaments Single or Pack of 5



- PLA in 1kg reels for the Sketch and Sketch Large.
- A great material for early concept models because it is easy to use, education-friendly.
- A corn-based plastic and is considered biodegradable under industrial processes.
- \*Assorted pack of 5 includes:- Blue, Yellow, Red, Green and Grey.

CODE	Description	Unit	1+
MBT431ORG	Orange	1	<b>56.95</b>
MBT451RED	Red*	1	<b>56.95</b>
MBT461WHT	White	1	<b>56.95</b>
MBT481BLU	Blue*	1	<b>56.95</b>
MBT481BLK	Black	1	<b>56.95</b>
MBT491GRY	Grey*	1	<b>56.95</b>
MBT511YEL	Yellow*	1	<b>56.95</b>
MBT531GRN	Green	1	<b>56.95</b>
MBT551ASS	Assorted	Pack of 5	<b>255.00</b>

## MakerBot Method 3D Printer



- Patented VECT™ 110 Thermal Regulation evenly heats and controls the print environment leading to parts that are 2 x stronger and 2 x more accurate.
- 15 patented technologies combine to control the print environment resulting in superior results from the 25+ tuned materials to limitless 3rd party materials with the LABS GEN 2 Extruder.
- Lab-quality parts made accessible to anyone powered by features like MakerBot CloudPrint™, Auto-Calibration and SmartAssist™ Material Loading to bring industrial power to your desktop.
- Dual extrusion build volume - 152L x 190W x 196H mm.
- Single extrusion build volume - 190L x 190W x 196H mm.

CODE	Description	Unit	1+
MBT900MDX	Method X	1	<b>See Website</b>

## MakerBot Extruders



- High performance extruder with industry-leading Stratasys® designed parts.
- MBT962EXT for the Method when using the tough precision PLA filament.
- MBT963EXT for the Method when using dissolvable PVA filament.

CODE	Description	Unit	1+
MBT962EXT	Extruder PLA	1	<b>270.50</b>
MBT963EXT	Extruder PVA	1	<b>270.50</b>

## MakerBot Tough Precision Filaments



- A tough PLA filament designed for the Method 3D Printer.
- Dimensionally accurate and increased toughness.

CODE	Description	Unit	1+
MBT988SGY	Slate Grey	1	<b>59.50</b>
MBT989BLK	Onyx Black	1	<b>59.50</b>
MBT990WHT	Stone White	1	<b>59.50</b>
MBT991ORG	Safety Orange	1	<b>59.50</b>

## MakerBot Dissolvable PVA Filament



- Dissolvable PVA support filament can also be used for intricate designs.
- Simply immerse in water to remove.

CODE	Description	Unit	1+
MBT998PVA		1	<b>68.25</b>

## Ultimaker 2+ Connect Bundle



- This bundle includes the Ultimaker 2+ Connect and the Air Manager which removes up to 95% of ultrafine particles and shields the print area.
- A reliable single extrusion 3D Printer that builds upon the award-winning benchmark of its predecessor, to add intuitive operation and deeper software connectivity.
- Network connectivity via Wi-Fi or Ethernet enables remote printing over the cloud with added security.
- Easy control with the 2.4-inch colour touchscreen

CODE	Description	Unit	1+
ULT200BND	2+ Bundle	1	<a href="#">See Website</a>

## Ultimaker S3 3D Printer



- An advanced and precise dual extrusion desktop 3D printer with advanced features to ensure a reliable printing experience.
- Combine build materials with water-soluble support to create complex mechanical parts and intricate surfaces – or choose to print with two colours. Ultimaker 3 has a unique auto nozzle-lifting system that ensures a smooth, professional finish with every print, giving you complete design freedom.
- Simple to use thanks to its award-winning touch interface, Wi-Fi, LAN, and NFC connectivity with seamless software integration
- Before every print, the capacitive print head sensor probes the removable heated built plate at multiple points to find microscopic variations in its topology. The tilt angle is then compensated by adjusting the Z-height in the first layers.
- Dual extrusion build volume: 197 x 215 x 200 mm.

CODE	Description	Unit	1+
ULT300PRT	S3 3D Printer	1	<a href="#">See Website</a>

## Ultimaker S7 Pro Bundle



- Every spool is kept below 25% relative humidity, making it easy to realize more 3D printing applications with almost any combination of polymers and abrasive composites.
- Each of the Material Station's material bays have NFC readers and reinforced prefeeders for integration with UltiMaker Cura and Digital Factory.
- Flexible build plate - a unique PEI coating allows quick and easy print removal, without the need for glue. Then snap it securely back in place for a huge increase productivity.
- Inductive sensor probes the build plate with less electrical noise and more accuracy. Now you can truly start a print and walk away – confident in a perfect first layer.
- Integrated Air Manager not only increases the air quality but also boosts print quality thanks to its fully enclosed build chamber and single glass door.

CODE	Description	Unit	1+
ULT700BND	S7 Pro Bundle	1	<a href="#">See Website</a>

## UltiMaker PVA Removal Station



- Dissolves support material quickly and effectively, keeping operator time to a minimum and increasing productivity.
- High-speed water circulation driven by a magnetic rotor removes PVA much faster than motionless water – even from hard-to-reach cavities.
- Use with UltiMaker or 3rd-party PVA. Just add water - no chemicals and no mess.

Specification	
Container volume	13.7 litres
Maximum part size	W 200 x D 230 x H 165 mm
Rotor speed	225 RPM (normal), 100 RPM (low)
Operating sound	< 50 dBA
Dimensions	W 303 x D 325 x H 374 mm W 11.9 x H 12.8 x D 14.7"

CODE	Description	Unit	1+
ULT100WSH	PVA Removal	1	<a href="#">See Website</a>

## ULTIMAKER PLA FILAMENTS

Please see website for **more colours** and **prices**

### PLA Plastic Filaments



- 0.75kg. 2.85mm diameter and approximately 90m long.
- For reliable high-resolution prints with fine details
- Made from renewable sources, so it's biodegradable too.
- When you're casting metal parts through lost PLA casting
- Perfect for printing in education or in the office, thanks to low ultrafine particle emissions
- A heated bed isn't necessary, it works with glue and blue tape as well
- PLA isn't suitable for medium temperature applications (50° C) or long-term outdoor usage.

### Tough PLA Plastic Filaments



- Tough PLA is a technical PLA filament with toughness comparable to Ultimaker ABS.
- Offers the same safe and easy use as regular PLA.
- Tough PLA is less brittle than regular PLA and gives a more matte surface finish quality.
- Heat resistance is similar to standard PLA filaments, so printed parts should not be exposed to temperatures above 60 °C.
- More reliable than ABS for larger prints, with no delamination or warping.
- Ultimaker Tough PLA is also compatible with Ultimaker support materials (PVA and Breakaway) giving full geometric freedom when designing parts.

### Natural PLA Filament



- 750g. 2.85mm diameter and approximately 90m long
- PVA (Polyvinyl Alcohol) is a water-soluble support material for multi-extrusion 3D printing.
- Ideal for printing complex models that require supports for large overhangs, deep internal cavities, and intricate geometries.
- Good thermal stability resulting in better degradation resistance compared to other PVA filaments
- Less moisture sensitive than other PVA filaments and great adhesion to both PLA and Nylon
- Safe dissolution in tap water (no harmful chemicals required) - biodegradable with no hazardous by-products.

## EinScan SE Desktop 3D Scanner



- A cost-effective 3D scanner ideal for educational use, from Primary to Further Education. Uses a visible white light, so no laser to cause eye damage.
- Automatic calibration and easy operation for a high quality scan, compatible with 3D printers.
- Fixed scan with or without turntable – 8 seconds for a single scan or 2 minutes for a 360 degree.
- Auto meshing to watertight 3D data with software functions to smooth, sharpen or fill holes.
- Fixed scan max size: 700 x 700 x 700mm, Auto scan max size: 200 x 200 x 200mm.

CODE	Description	Unit	1+
ESN100WSE	SE Desktop 3D Scanner	1	<a href="#">See Website</a>

## EinScan SP Desktop 3D Scanner



- Expert choice 3D scanner ideal for educational use where high resolution scans are required. Uses a visible white light, so no laser to cause eye damage.
- High accuracy calibration for reverse engineering and design. Fixed scan with or without turntable – 4 seconds for a single scan or 1 minute for a 360 degree.
- Auto meshing to watertight 3D data with software functions to smooth, sharpen or fill holes.
- Fixed scan max size: 1200 x 1200 x 1200mm. Auto scan max size: 200 x 200 x 200mm.

CODE	Description	Unit	1+
ESN200WSP	SP Desktop 3D Scanner	1	<a href="#">See Website</a>

## Berghmann Laser Cutters



### BERGHMANN

Model	BER468LSR	BER690LSR	BER912LSR
<b>Standard Features</b>			
Engraving	✓	✓	✓
Cutting	✓	✓	✓
Fall/Rise Table	✓	✓	✓
Rotary Axis	✓	✓	✓
Red Beam Positioning	✓	✓	✓
Hatch for Larger Material	✓	✓	✓
Outlet Fume Extraction	✓	✓	✓
Water-Cooled Laser Tube	✓	✓	✓
Black Anodised Bed	✓	✓	✓
Honeycomb Work Table	✓	✓	✓
CO2 Laser Safety Glasses	✓	✓	✓
Laser Head Air Assist	✓	✓	✓
USB Connection	✓	✓	✓
<b>Technical details</b>			
Engraving Area (mm)	400x600	600x900	900x1200
Laser Power (W)	80	80	80
Engraving Speed (M/min)	0-60	0-60/80	0-60
Cutting Speed (M/min)	0-40	0-30	0-40
Repos. Accuracy (mm)	0.1	0.1	0.1
Power Supply (V/Hz)	110-220/50	110-220/50	110-220/50
Operating Temperature	5-40°C	5-40°C	5-40°C
Operating Humidity	5-90%	5-90%	5-90%
Dimensions (mm)	1450 x 850 x 950	1450 x 1050 x 950	1850 x 1350 x 950

- The Berghmann Laser Cutter has been sold into the industry for some time but we now have the exclusive distribution in the UK. They are easy to use, compatible with all common drawing packages and the back-up and service levels are excellent. We have included the laser tube replacement (the tubes do have a long life) as an indicator of their commitment to maintenance - so in a number of years time you're not left with a machine that's too expensive to repair.
- Installation, machine set-up and full training are included; the only requirements are a power source and an external outlet for the extraction of fumes (alternatively a Berghmann Laser Fume extractor can be purchased).
- Runs on RD Works which is compatible with most standard CAD packages.
- Cuts all standard materials including wood, acrylic, card, leather, rubber, cork etc.
- Cuts and engraves in same operation.
- Compact design with easy use controls.
- Red dot pointer included as standard.

### Berghmann Laser Tubes

The laser tube can be purchased for self-installation or we can quote for an engineer to fit and calibrate.

### What is included in the price?

- CE Conformity, Rotary Axis, Fall/Rise Table, 2in Lens, Red Dot Pointer, Black Anodised Bed, Hatch for Larger Material, Fume Extraction Outlet and Motor, Water-Cooled Laser Tube, Laser Head Air Assist, USB Connection, CAM Software, Water chiller, Air Pump, CO2 Laser Safety Glasses.
- Commissioning and Training on site included - customer provides electrical power connection.
- 1 year parts warranty, 3 months warranty on laser tube.
- UK delivery included.

CODE	Description	Unit	1+
BER460LSR	400 x 600mm - 80W	1	<a href="#">See Website</a>
BER698LSR	600 x 900mm - 80W	1	<a href="#">See Website</a>
BER912LSR	900 x 1200mm - 80W	1	<a href="#">See Website</a>
BER080RLT	Laser Tube - 80W	1	<a href="#">See Website</a>

### MACHINES & POWER TOOLS

## COMING SOON GCC Lasers

See website [www.tilgear.co.uk](http://www.tilgear.co.uk)



## Flux Laser Cutters

- High resolution precise cutting to 1000 DPI using a laser that's smaller than the width of a human hair and detailed engraving with a 0.05mm layer depth.
- Built-in HD camera for accurate positioning and interlocked cabinet for safety.
- Very easy to install from the box – no engineer required. Connects to the Beam Air for efficient extraction and filtration.
- Includes free Beam Studio software to create and import all types of designs and images. Compatible with many professional design software's, for seamless integration of Adobe Illustrator or to directly import designs from AutoCAD, Inkscape, CorelDraw, Photoshop, and even Microsoft Word – see our website for further details regarding compatibility.

## Flux Beamo Laser Cutter



- A portable 30-watt CO2 laser, which engraves and cuts various laserable materials (up to 5mm acrylic).
- Overall size: 615 x 445 x 177mm, work area: 300 x 210mm, weight 22kg.

## Flux Beambox Laser Cutter



- A compact 40-watt CO2 laser, which engraves and cuts most laserable materials (up to 5mm acrylic).
- Overall size: 830 x 670 x 250mm, work area: 400 x 375mm, weight 40kg.

## Flux Beambox Pro Laser Cutter



- A powerful 50-watt CO2 laser, which engraves and cuts most laserable materials (up to 8mm acrylic).
- Overall size: 1030 x 670 x 250mm, work area: 600 x 375mm (product capacity 640 x 445mm), weight 48kg

CODE	Description	Unit	1+
FLU330BEM	Beamo	1	<b>2075.00</b>
FLU440BBX	Beambox	1	<b>3325.00</b>
FLU650BXP	Beambox Pro	1	<b>4275.00</b>

## Flux Hexa Laser Cutter



- Top of the range fast and powerful 60-watt CO2 laser, which engraves and cuts most laserable materials (up to 10mm acrylic).
- Cortex M4 core chips lets you engrave with a mind-blowing speed of 900mm/s, meaning it has the capability of being 200% faster than other desktop cutters.
- Electric lifting platform with built-in autofocus, and safety auto-stop if the cover is opened.
- Very easy to install from the box – no engineer required. Connects to the Berghmann Laser Cutter Extractor for efficient extraction and filtration.
- Overall size: 1110 x 670 x 273mm, work area: 730 x 410mm, weight 58kg.
- Includes free Beam Studio software to create and import all types of designs and images. Compatible with many professional design software's, for seamless integration of Adobe Illustrator or to directly import designs from AutoCAD, Inkscape, CorelDraw, Photoshop, and even Microsoft Word – see our website for further details regarding compatibility.

CODE	Description	Unit	1+
FLU760HXA	Hexa	1	<b>6330.00</b>

## Flux Beam Air



- Designed to be used with the Beamo, Beambox and Beambox Pro, to suck dust and filter odours.
- Highly effective 4-layer filtration system - pre, main, charcoal and hepa filters.
- Beam Air will turn on and off automatically with the laser cutter, if connected by a USB-B cable.
- Brushless motor with super air intake.
- Overall size: 490 x 490 x 300mm, weight 17kg.

Carriage extra, please see website

CODE	Description	Unit	1+
FLU200AIR	Beam Air	1	<b>917.50</b>

## Graphtec CE7000 Cutting Plotter

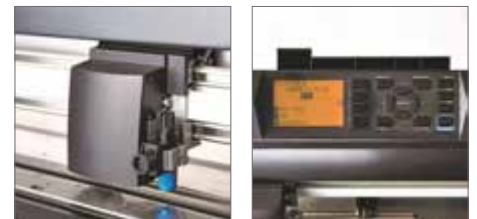

- Rugged "Workhorse" design with a 2 year warranty featuring a large graphic type LCD control panel.
- Includes high quality, easy to use, professional grade Graphtec Pro Studio software which operates either a knife or pen (both included).
- Fast cutting speed of up to 1000mm/s on the 1300mm model and a cutting force of 450g.
- Pre-printed graphics can be cut without user input by using the latest barcode technology.
- Available in widths: 400mm desktop, 600mm with stand and 1300mm with stand.

CODE	Description	Unit	1+
GRT407CPT	400m	1	<b>1445.00</b>
GRT607CPT	600m	1	<b>1765.00</b>
GRT137CPT	1300m	1	<b>4275.00</b>
GRT009BLD	Spare Blade	1	<b>35.95</b>

## Silhouette Portrait 3



- The latest edition of this lightweight portable 8"/200mm wide digital cutting tool with a 2mm depth of cut.
- Wireless Bluetooth connectivity or USB cable, with an AutoDetect Autoblade and new matless cutting mode.
- PixScan Compatibility for print and cut Jobs - compatible with both Windows and MAC systems.
- Includes Pen Adapter for sketch pens, Silhouette Studio Software (Basic Edition), 50 free digital designs, power cable and USB cable.
- Full UK technical support and a 2 Year UK warranty.

CODE	Description	Unit	1+
SLH300PRT	Portrait 3	1	<b>194.95</b>

## Silhouette Cameo 4



- A digital cutting tool with increased speed, capacity and more cutting options, now with Bluetooth wireless connectivity or USB cable.
- Autoblade with inbuilt chip for tool recognition - will cut paper, cardstock, vinyl and fabric up to 300mm/12" wide.
- Built-in roll feeder, crosscutter and upgraded Silhouette software Matless die cutting - tool head is offset therefore carrier sheet not needed for die cutting.
- 3 year warranty and full UK telephone support.

CODE	Description	Unit	1+
SLH404CAM	Cameo 4	1	<b>328.95</b>
SLH333BLD	Replacement Blade	1	<b>17.95</b>

## Silhouette Cameo 4 Pro



- The largest machine in the Silhouette family with a 610mm/24" cutting width and cutter clearance of 3mm.
- The upgraded software enables increased speeds and the Autoblade with inbuilt chip tool recognition - will cut paper, cardstock, vinyl and fabric.
- Built-in roll feeder, vinyl crosscutter and matless die cutting - the tool head is offset therefore a carrier sheet is not needed for die cutting.
- Bluetooth wireless connectivity or USB cable and includes a sketch pen adaptor and 100 free digital designs.
- 2 year warranty and UK technical support.

CODE	Description	Unit	1+
SLH424PRO	Cameo 4 Pro	1	<b>636.95</b>

## Vinyl Sheet Self-Adhesive Single Sheet or Assorted Pack of 12



- A superior quality calendared sign making vinyl for use with cutting plotter, cuts economically in half for use with the Silhouette Cameo.
- 70 micron intermediate grade soft handle face film.
- Advanced acrylic adhesive.
- Internal or external applications onto flat or curved surface.
- Durability is 5 years for black and white, 4 years colours and 3 years for metallics..
- 610mm x 5m roll.

CODE	Description	Unit	3+	1+
VSA400WHT	White	1	<b>17.25</b>	18.75
VSA410BLK	Black	1	<b>17.25</b>	18.75
VSA435BYL	Buttercup	1	<b>17.25</b>	18.75
VSA433ORG	Orange	1	<b>17.25</b>	18.75
VSA443CRD	Cherry	1	<b>17.25</b>	18.75
VSA4520BU	Ocean Blue	1	<b>17.25</b>	18.75
VSA455UBU	Ultramarine Blue	1	<b>17.25</b>	18.75
VSA468MGR	Meadow Green	1	<b>17.25</b>	18.75
VSA482MGT	Magenta	1	<b>17.25</b>	18.75
VSA483PUR	Purple	1	<b>17.25</b>	18.75
VSA490SLV	Silver	1	<b>17.25</b>	18.75
VSA491GLD	Gold	1	<b>17.25</b>	18.75
VSA120ASS	Assorted	Pk 12		<b>189.50</b>

## Denford Duo



Shown with optional universal bench and 2 x computer support extensions (PC's not included).

- A combined introductory CNC Milling and Turning Package, incorporating the Micromill Pro CNC Milling Machine and Microturn Pro CNC Lathe, complete with tooling and software.
- Ideal for proving student designs and for producing small components in materials such as wax, plastic, acrylic and free-cutting alloys.
- Both machines have totally enclosed interlocking guards.
- Variable spindle speeds and feed rates on both the Micromill and Microturn.

CODE	Description	Unit	1+
DEN800DUO	Denford Du0	1	<b>See Website</b>

## Denford Microturn



- A compact 2 axis CNC lathe.
- Fitted with totally enclosed interlocking guards - the ideal introduction to small part CNC manufacture.
- Variable spindle speeds and feedrates make this ideal for cutting resistant materials such as wax, plastic, acrylic, aluminium and free cutting alloys.
- Supplied with software, chuck, faceplate, centres, toolpost and turning tool.
- Overall dimensions 685 x 654 x 688mm, weight 50kg, 1ph.

CODE	Description	Unit	1+
DENMICTRN	Microturn	1	<b>See Website</b>

Specification	
Machine Length (A)	685mm - 26.97in
Machine Depth (B)	654mm - 25.75in
Machine Height (C)	688mm - 27.09in
Machine Weight	80kg - 176.37lbs
Table Size	n/a
Swing Over Bed	90mm - 3.5in
Travel X Axis	50mm - 1.97in
Travel Y Axis	n/a
Travel Z Axis	126mm - 4.96in
Table to Spindle	n/a
Max. Spindle Speed	2500rpm
Max. Feed Rate	600mm/min 23.62in/min
Max. 3D Profiling	n/a
Spindle Motor	75W - 0.1HP
Axes Motors	Stepper
Power Requirements	Single Phas 230V - 8A /110V - 10A
Frequency	50/60Hz

## Denford Micromill



- A compact 3 axis CNC milling machine.
- Fitted with totally enclosed interlocking guards - the ideal introduction to small part CNC manufacture.
- Variable spindle speeds and feedrates make this ideal for cutting resistant materials such as wax, plastic, acrylic, aluminium and free cutting alloys.
- Supplied with software, 1/4" collet, slot drill and clamping kit.
- Overall dimensions 685 x 654 x 688mm, weight 57kg, 1ph.

CODE	Description	Unit	1+
DENMICMLL	Micromill	1	<a href="#">See Website</a>

## Denford CNC Router Compact 1000/1000 PRO



*Shown with optional universal bench and computer support extension. (PC not included).*

- A compact 3 axis CNC Router with totally enclosed interlocking guard.
- Is ideal for cutting a range of resistant materials such as hard and soft wood, plastic, modelling foam, acrylic and prototyping materials.
- X Axis 400mm x Y Axis 240mm x Z Axis 110mm.
- In addition, the Router 1000Pro can cut non-ferrous metals.

CODE	Description	Unit	1+
DEN100RTR	Compact 1000	1	<a href="#">See Website</a>
DEN100PRO	Compact 1000 PRO	1	<a href="#">See Website</a>

## Denford CNC Router 6600/6600 PRO



- A large format, high speed Router, complete with built-in machine bench, offering large machining capacity (table size 1080 x 640mm) at an exceptional price.
- The Router 6600 / 6600 Pro is specifically designed for education and training and is ideal for cutting a range of resistant materials such as hard and soft wood, plastic, modelling foam, acrylic and prototyping material.
- In addition, the Router 6600 Pro can cut non-ferrous metals.
- X Axis 1000 x Y Axis 600 x Z Axis 110mm
- VR CNC Milling Operating Software (PC not included).
- QuickCAM 2D Design software (single seat)
- Aluminium T Slot Table.
- Outlet for Dust Extraction System.
- Workholding Clamps.
- Installation and Instruction Manuals.
- USB Connection.

CODE	Description	Unit	1+
DEN660RTR	Router 6600	1	<a href="#">See Website</a>
DEN660PRO	Router 6600 PRO	1	<a href="#">See Website</a>

## Denford PCB Engraver



- A 3 axis CNC PCB and Engraving Machine with totally enclosed guarding, suitable for all levels of education and training.
- Supplied with operating software incorporating Gerber and DXF import facilities.
- The PCB Engraver is ideal for cutting and engraving a range of materials, including copper board, plastic and acrylic.
- Powerful operating software that is simple to use and allows multiple designs to be made at once.
- High speed spindle motor and floating head technology.
- Basic tools and depth setting device.
- Outlet for dust extraction.
- Installation and Instruction Manuals.
- USB Connection.
- Please Note:  
Dust extraction is essential to allow the machine to function. The DP-50 is ideal- Please enquire.
- X axis 330mm x Y axis 210mm x Z axis 40mm.

CODE	Description	Unit	1+
DENPCBENG	PCB Engraver	1	<a href="#">See Website</a>

## Denford CNC Router 2600/2600 PRO



*Shown with optional universal bench, optional computer support extension and optional integrated Dust Pro 100 (PC not included).*

- A 3 axis CNC Router with totally enclosed interlocking guard suitable for all levels of education and training.
- Ideal for cutting a range of resistant materials such as hard and soft wood, plastic, modelling foam, acrylic and prototyping materials.
- In addition, the Router 2600 Pro can cut non-ferrous metals.
- X Axis 600 x Y Axis 400mm x Z Axis 110mm.
- VR CNC Milling Operating Software (PC not included).
- QuickCAM 2D Design software (single seat). Site/network options available.
- Aluminium T Slot Table.
- Outlet for Dust Extraction System.
- Workholding Clamps.
- Installation and Instruction Manuals.
- USB Connection.

CODE	Description	Unit	1+
DEN260RTR	Router 2600	1	<a href="#">See Website</a>
DEN260PRO	Router 2600 PRO	1	<a href="#">See Website</a>

## Denford CNC Milling Machine VMC 1300/1300 PRO



*Shown with optional universal bench and optional computer support extension. (PC not included).*

- A 3 axis milling machine available either floor standing or for bench mounting, with totally enclosed high visibility interlocking guard, suitable for all levels of education.
- Programmable spindle speeds and feedrates make the VMC 1300 ideal for cutting a range of resistant materials such as wax, plastic, acrylic, free cutting alloys, aluminium and steel.
- The VMC 1300 PRO has a more powerful, higher speed spindle (6000 rpm) for heavy duty cutting.
- VR CNC Milling Operating Software (PC not included).
- QuickCAM 2D Design software (1 seat).
- Power Drawbar with Manual Actuation.
- Workholding Clamps.
- Installation and Instruction Manuals.
- USB Connection.
- X Axis 250mm x X Axis (without ATC) 375mm x Y Axis 160mm x Z Axis 235mm.

CODE	Description	Unit	1+
DEN130VMC	VMC 1300	1	<a href="#">See Website</a>
DEN130PRO	VMC 1300 PRO	1	<a href="#">See Website</a>



## Denford CNC Lathe Turn 270 PRO



- Compact 2 axis CNC Lathe with totally enclosed high-visibility interlocking guard, suitable for all levels of education and training.
- VR CNC Turning Operation Software (PC not included).
- QuickTURN 2D Design software (1seat).
- Quick Change Toolpost and Holder.
- Manual Self Centring 100mm 3 Jaw Chuck.
- Installation and Instruction Manuals.
- USB Connection.
- Swing Over Bed 190mm x Distance Between Centres 270mm x X Axis 150mm x Z Axis 225mm

CODE	Description	Unit	1+
DEN27MPRO	Turn 270 PRO	1	<b>See Website</b>

## Denford CNC Lathe Turn 370 PRO



- High capacity 2 axis CNC Lathe complete with flood coolant and industrial base and totally enclosed high-visibility interlocking guard.
- Programmable spindle speeds and feedrates make the Turn 370 PRO ideal for cutting a range of resistant materials such as wax, plastic, acrylic, free cutting alloys, aluminium and steel.
- VU CNC Turning Operating Software (PC not included).
- QuickTURN 2D Design software (1 seat).
- Flood Coolant and Industrial Cabinet Base.
- Quick Change Toolpost and Holder.
- Manual Self Centring 125mm 3 Jaw Chuck.
- Installation and Instruction Manuals.
- USB Connection.
- Swing Over Bed 260mm x Distance Between Centres 370mm x X Axis 200mm x Z Axis 275mm.

CODE	Description	Unit	1+
DEN37MPRO	Turn 370 PRO	1	<b>See Website</b>

## Boxford 160TCLi Bench Mounted CNC Lathe



- Bench mounted CNC Lathe designed for educational and training purposes.
- Rigid construction allows steel to be cut to close tolerances.
- The Boxford software is an integrated suite of powerful CAD/CAM tools.
- A full 3D simulation of the manufacturing process, including a cycle time.
- Manual Data Input, utilising Industrial Standard Codes, allows programs to be entered using either line by line or conversational programming.
- Drawings from other CAD applications can also be imported and processed.
- The machine rigidity and spindle torque allows a large variety of materials and components to be machined.
- Touch sensitive control panel incorporating illuminated push buttons, operates without a computer.

CODE	Description	Unit	1+
BXF160LTH	Boxford 160TCLi	1	<b>See Website</b>

## Boxford 190VMCxi Bench Mounted Machining Centre



- Vertical Machining Centre designed for educational and training installations, with a rigid construction allowing steel to be cut to close tolerances.
- The Boxford software is an integrated suite of powerful CAD/CAM tools.
- The CAD software provides a variety of drawing tools including text fonts with excellent manipulation routines.
- Excellent Z axis travel for 3D manufacture and rigid machine construction allows the use of high material removal rate.
- Touch sensitive control panel can be operated with a computer. Drawing from other CAD applications can also be imported and processed.
- Full 3D simulation of the manufacturing process, including a cycle time, no need for trail runs.

CODE	Description	Unit	1+
BXF190MLL	Boxford 190VMCxi	1	<b>See Website</b>

**COMING SOON**  
Please contact us for more information

### UNIMAT

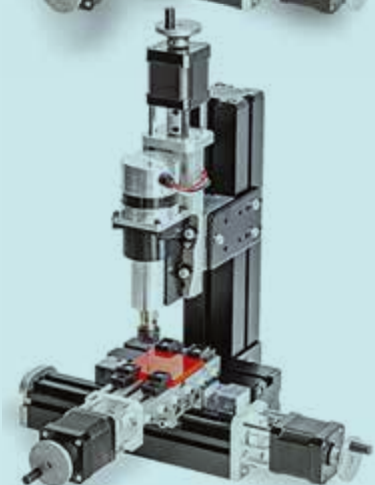
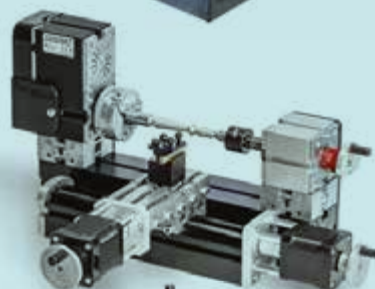

### MEGA



## Berghmann Fume Extractor



### BERGHMANN

- A digital high efficiency fume extractor with three stage filtration (main filter, fine particle filter and fume filter).
- All functions are fully automatic; all the user has to do is set the appropriate airflow on installation.
- Lower energy consumption by using variable speed motors and automatic flow control.
- Increase filter life by using the optimal extraction rate.
- Interface with other equipment eg a laser cutter.
- Maintain a constant extraction rate to prevent fume escape or damage to equipment.

#### System features

- Submicron (HEPA) filter removes 99.997% of particles down to 0.3 microns.
- Activated carbon filtration removes harmful gas.
- Simple to install and quiet in operation.

CODE	Description	Unit	1+
BER300DFE	Fume Extractor	1	<b>1550.00</b>
BER300MNF	Main Filter	1	<b>310.00</b>
BER300PRF	Pre-Filter	1	<b>138.95</b>

## Berghmann Bandsaw Extractor 1ph or 3ph



### BERGHMANN

- A stand-alone extractor which is ideal for use with large band saws and has sufficient performance to provide both bottom and top extraction. Supplied as a single phase or a three phase machine.
- Designed to be low-enough to sit below the bed of the band saw so as to avoid any obstructions.
- Machine Width: 550mm
- Machine Depth: 730mm
- Machine Height: 865mm.
- Capacity of Dust Tray: 18 litres.
- Motor power rating: 0.75w (1hp) 230/1/50 or 400/3/50.

CODE	Description	Unit	1+
BER400BSW	Bandsaw Extractor 1ph	1	<b>See Website</b>
BER403BSW	Bandsaw Extractor 3ph	1	<b>See Website</b>

## Berghmann Underbench Extractor 1ph or 3ph



### BERGHMANN

- A high performance, fully certified extractor, ideal for use with bench mounted fretsaws.
- Conveniently fits beneath a worktop and can be wired to run in conjunction with multiple machines.
- This professional product is fabricated from steel with a painted finish.
- Compact for under- bench housing. Sanders and other bench machines.
- Features a filter performance gauge and key locking door.
- The extractor is designed to be wired in with your machine so that it starts when the machine is turned on. A No Volt Release Starter is available if required, to enable independent start up.
- Not suitable for extracting metal filings.
- Available in either single phase or 3 phase supply.

CODE	Description	Unit	1+
BER200UBE	Under-bench Extractor 1ph	1	<b>See Website</b>
BER203UBE	Under-bench Extractor 3ph	1	<b>See Website</b>

## Berghmann Heavy Duty Under Bench Extractor



- A heavy duty high performance, fully certified extractor for use with all bench mounted machines including fretsaws and sanders. Conveniently fits beneath a worktop and can be wired to run in conjunction with multiple machines.
- The extractor is designed to be wired in with your machine so that it starts when the machine is turned on. A No Volt Release Starter is available if required, to enable independent start up.
- Features a filter performance gauge and key locking door, not suitable for extracting metal filings.
- 4x cartridge filters offering 7.43m2 of filter area, plus HEPPA after filters.
- Available in single or three phase.

CODE	Description	Unit	1+
BER700UBE	H.Duty 1ph	1	<b>See Website</b>
BER703UBE	H.Duty 3ph	1	<b>See Website</b>

## Berghmann Compact Extractor 1ph



### BERGHMANN

- This compact extractor can be made easily portable due to its simple filter design.
- Can be used to extract everything from fine dusts to wood chippings and planer shavings.
- Ideal for fitting in locations where space is tight.
- Multitude of inlet sizes are available (please specify on orders.)
- Machine Width: 500mm.
- Machine Depth: 500mm.
- Machine Height: 685mm (add 60mm for inlet ports on top.).
- Motor power rating: 0.55Kk (0.75hp) 230/1/50.

CODE	Description	Unit	1+
BER100CMP	Compact Extractor 1ph	1	<b>See Website</b>

## Berghmann Circular Saw Extractor 1ph or 3ph



### BERGHMANN

- Specifically designed for use with circular saws.
- Multiple inlets to serve a number of extraction ports that may be fitted to either a planer or a circular saw.
- Fitted with a wooden run off board which is also height adjustable.
- Floor area of unit: 815mm x 1250mm.
- Table height adjustment: 840mm x 940mm.
- Capacity of dust tray: 40 litres.
- Motor power rating: 1.5w (2hp) 400/3/50 or 230/1/50.

CODE	Description	Unit	1+
BER500CSW	Circular Saw Extractor 1ph	1	<b>See Website</b>
BER503CSW	Circular Saw Extractor 3ph	1	<b>See Website</b>

## Berghmann PL16 Planer Thicknesser Extractor

Single Phase or Three Phase



- Designed specifically for use with machines that produce bulk waste, such as planers and wood lathes.
- Versatile design for coarse dusts, hence the large collection bin capacity.
- Low noise for use in the classroom, with a relatively low footprint area for the machine.
- Available in 1ph and 3ph.

CODE	Description	Unit	1+
BER80PL16	PL16 - 1ph	1	<a href="#">See Website</a>
BER83PL16	PL16 - 3ph	1	<a href="#">See Website</a>

## Berghmann Modular Extraction Unit



- Modular industrial Extraction Unit is designed for larger prep room/ work shop extraction.
- Fitted with 144ft<sup>2</sup> of filter area and a vibratory auto-shake system which will provide a long filter life.
- Sound clad as standard and is fitted with 2x 150L collection bins.
- Galvanised Steel and is then painted to add further weather protection.
- Easily modified in the future and can have additional fans fitted to it if necessary.
- Fitted with tubular filters as they are more suited to wood waste applications.
- Manufactured to be fully ATEX compliant.
- Our engineers are fully qualified and trained - NIC EIC registered.

CODE	Description	Unit	1+
BER900MEU	Modular Unit	1	<a href="#">See Website</a>

## Purex CUB3D Extractor



- Designed to remove the toxic fumes generated by 3D printing, but also can be used to extract solder fumes.
- Compact and quiet machine with adjustable airflow for a balanced extraction - 240V.
- Activated carbon filtration removes harmful gas and particles down to 0.3 microns.
- Supplied with a kit comprising: 50mm x 2m flexible hose, bench bracket, connectors, valve, 50mm stainless steel flexible arm and large clear hood cowl.
- L 308 x W294 x H366mm - 12kg.

CODE	Description	Unit	1+
PRX333DEX	CUB3D	1	<a href="#">See Website</a>
PRX110MFL	Main Filter	1	<a href="#">See Website</a>
PRX200PFL	Pre-Filter	Pack of 4	<a href="#">See Website</a>

## Numatic NV750 Extractor



- The Numatic NV750-s vacuum incorporates a "Twinflo" vacuum motor providing more than enough power for most cleaning tasks.
- Complete with a "Permatex" filter giving a filtration level down to 0.5 microns, further enhanced by the included pack of "HEPAFLO" disposable bags.
- Fitted with a 32mm-51mm cyclonic entry suitable for connecting a range of specialist accessories.
- 2.5m vacuum hose with rubber cuss up to 58mm and crevice tool are supplied.
- Twin 1200W 230V motors.

CODE	Description	Unit	1+
NUM750EXT	Extractor 1200W	1	<a href="#">See Website</a>

## Nilfisk Aero 26 Extractor & Vacuum

110V or 240V



- The Nilfisk Aero 26 is a L class 1,250 power tool extractor, wet and dry vacuum with exhaust air blow function.
- Auto power tool take off (up to 1800 watt) provides effective dust extraction from fretsaws, sanders, routers, planers, saws, drills etc.
- Push and clean semi-automatic filter cleaning system maintains the performance for longer life.
- 25l polypropylene canister with lifting handle, weight 9kg.
- Washable PET cartridge filter, fleece filter dust bag.
- 5m (240 Volt) or 7.5m (110 Volt) cable and 3.5m x 36mm diameter suction hose.
- Tool kit comprising: 2 piece stainless steel suction tube, wet and dry floor nozzle, universal nozzle, brush nozzle, crevice tool and power tool adaptor with suction regulator.
- Dimensions: 375 x 390 x 530mm.
- Bags: Unaffected by humidity, moisture or liquids.

CODE	Description	Unit	1+
NLF262VAC	240V	1	<b>199.00</b>
NLF261VAC	110V	1	<b>275.00</b>
NLF265BAG	Bags	Pack of 5	<b>19.95</b>

## Numatic Industrial Vacuum Cleaner



- Powerful Twinflo motor - 620W 230V.
- Tritex filtration with 9l capacity.
- Rewind and storage of 12.5m cable.
- Complete with standard accessories.

CODE	Description	Unit	1+
NUM120VCR	Industrial Vacuum Cleaner	1	<b>145.75</b>
NUM010BAG	Hepa-Flo Bags	Pack of 10	<b>15.75</b>

## Y Joint Connector



- Y – Shape connector.
- For use with 63mm or 100mm extraction systems.
- Available in two options.

CODE	Description	Unit	1+
DEF063YCN	63 x 63 x 63mm	1	<b>9.50</b>
DEF100YCN	100 x 100 x 100mm	1	<b>12.95</b>

## Straight Connector



- Straight connector.
- For use in 100mm diameter workshop dust extraction systems.

CODE	Description	Unit	1+
DEF063SCN	63 x 63mm	1	<b>12.95</b>
DEF100SCN	100 x 100mm	1	<b>4.80</b>

## T Joint Connector



- T-Shape connector.
- For use with 63mm or 100mm extraction systems.

CODE	Description	Unit	1+
DEF063TCN	63 x 63 x 63mm	1	<b>9.50</b>
DEF100TCN	100 x 100 x 100mm	1	<b>12.75</b>

## Elbow Connector 90°



- 90° elbow connector.
- For use with 63mm or 100mm extraction systems.

CODE	Description	Unit	1+
DEF063ECN	63 x 63mm	1	<b>10.95</b>
DEF100ECN	100 x 100mm	1	<b>14.25</b>

## Metal Blast Gate



- Metal blast gate used to close off the suction to a machine when not in use.
- For use with 100mm diameter systems.

CODE	Description	Unit	1+
DEF100MBG	100 x 100mm	1	<b>14.25</b>

## Plastic Blast Gate



- Plastic blast gate used to close off the suction to a machine when not in use.
- For use with 63mm or 100mm extraction systems.

CODE	Description	Unit	1+
DEF063PBG	63 x 63mm	1	<b>6.25</b>
DEF100PBG	100 x 100mm	1	<b>12.75</b>

## Threaded Connector



- Threaded adaptor for hose to fitment.
- For use in 100mm diameter workshop dust extraction systems.

CODE	Description	Unit	1+
DEF100THC	100 x 100mm	1	<b>9.50</b>

## Wire Hose Clamp



- For effectively securing hoses to fittings.

CODE	Description	Unit	1+
DEF038WHC	38mm	1	<b>2.40</b>
DEF065WHC	65mm	1	<b>3.20</b>
DEF100WHC	100mm	1	<b>3.20</b>

## Extractor Adaptors



- Reduces the diameter between hose sizes.
- For use with 63mm or 100mm extraction systems.

CODE	Description	Unit	1+
DEF163APT	100-63mm	1	<b>9.50</b>
DEF633APT	63-38mm	1	<b>7.95</b>

## Heat Shrink Adaptor



- Heat shrink adaptor, ideal for non-standard extraction ports.

CODE	Description	Unit	1+
DEF763HSA	76 - 38mm	1	<b>9.50</b>
DEF150HSA	100 - 50mm	1	<b>9.50</b>

## Dust Extraction Hose



- Right-hand helix clear PU hose.
- Made from tear resistant material.
- Reinforced with strong, flexible steel wire ribbing.

CODE	Description	Unit	1+
DEF382DEH	38mm x 2m	1	<b>25.95</b>
DEF380DEH	38mm x 10m	1	<b>89.95</b>
DEF652DEH	65mm x 2m	1	<b>37.50</b>
DEF650DEH	65mm x 10m	1	<b>131.25</b>
DEF102DEH	100mm x 2m	1	<b>39.95</b>
DEF100DEH	100mm x 10m	1	<b>160.50</b>

## Universal Adaptor



- For the joining of hoses of differing sizes.
- Featuring diameters from 25mm to 150mm.

CODE	Description	Unit	1+
DEF601APT	Universal	1	<b>23.75</b>

## Flared Nozzle



- A 250mm wide rectangular nozzle for collecting dust over.
- Ideal for dust control on woodturning lathes.
- For use with 100mm/4" extraction hose.

CODE	Description	Unit	1+
DEF250FNZ	100-250mm	1	<b>15.75</b>
DEF410FNZ	410 x 320mm	1	<b>39.50</b>

## Auto-switch for Machines and Extractor



- An intelligent controller that switches your extractor on and off automatically - as you use your power tool or small machine.
- Suitable for continuous operation, 220 - 240V 50/60 Hz AC with a resettable circuit breaker.
- Maximum tool or machine load is 2900watts (13A) and maximum extractor power is 1500watts.
- ABS fire retardant housing measures 128mm wide x 177mm high (including fixing tabs) x 56mm deep.
- CE and RoHS approved with IP20 - Class I protection.

CODE	Description	Unit	1+
DEF242AUT	Auto Control	1	<b>79.50</b>

## F-Tech Armour Mobile Welding Extractor



- Portable unit mounted on 4 swivel castors for easy movement around the workshop.
- Robust 3 metre Armoflex suction arm designed for maximum efficiency and high manoeuvrability.
- Filter efficiency 99.5% E12 classification, with usage shown on the digital panel plus a clogged filter alarmSpark arrestor, pre-filter and deep pleated filterUnit warranty 5 years and suction arm 1 year.
- Motor power: 1.1 Kw / 230V.
- Flow rate pressure: 1400 m3/h (at hood).
- Noise levels: 69 dB(A).
- Dimensions: 1010 x 520 x 920 mm.
- Weight: 85 Kg.

CODE	Description	Unit	1+
WEX140FTA	Mobile 230V	1	<b>1365.00</b>

SEE VOCATIONAL PAGES 158-160

## Welding Equipment



## F-Tech Portable Fume Extractor



- Lightweight but rugged portable unit designed to be placed by the working areaIncludes a flexible 50mm hose with a flared nozzle mounted on a magnetic support arm.
- Filter efficiency 99.5% E12 classification with Hourmeter to show usage.
- Spark arrestor, deodoriser carbon filter and cartridge filter.
- Unit warranty 2 years (this doesn't include the suction arm or filters).
- Motor power: 1.1 Kw / 230V.
- Flow rate pressure: 110m3/h.
- Noise levels: 72 dB(A).
- Dimensions: 580 x 300 x 370 mm.
- Weight: 20 Kg.

CODE	Description	Unit	1+
WEX011FTP	Portable 230V	1	<b>2170.00</b>

BenchVent

## BenchVent Filtration Unit BV300S/BV200S



A glue booth complete with spray shield for art, graphics, soldering and crafts. Available in either an A3 size (BV300S) or A2 size (BV200S) - designed predominantly for studio / classroom / workshop cleanliness and for immediate operator protection from airborne contaminants, fumes and particles. (They are not recommended for continual usage, i.e. production applications, particularly in confined and/or badly ventilated areas).

- High quality construction made in the UK, all BenchVent filtration and extraction systems carry a lifetime guarantee and are fully CLEAPSS compliant.
- Quiet in operation and can be assembled in seconds.
- These units can be used in two positions: Reclining position (on back-stand) or in the upright position.
- Filter unit with integral fan(s) has a back stand attached, spray shield, particulate filter and charcoal impregnated fibre filter.
- Available in either A3 or A2 sizes.

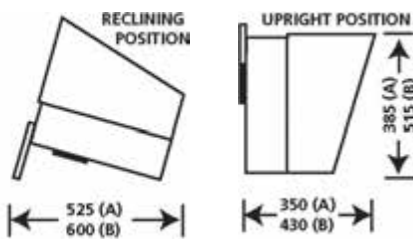
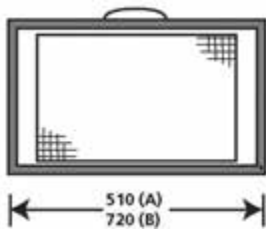

A Dimensions - BV300S B Dimensions - BV200S

CODE	Description	Unit	1+
BVT300SFU	BV300S	1	<b>395.00</b>
BVT200SFU	BV200S	1	<b>455.00</b>

## BenchVent Filtration Cabinet BV200H/BV100H



Hooded Spray Booth to capture, contain and filter potentially harmful substances within art, graphics, design technology areas, crafts and modelling. Ideally suited to applications such as the filtration of Aerosol adhesives (glue booth for Spray Mount), aerosol lacquers and fixatives and airbrush sprays applied to artwork. Drawing boards can be placed into the hoods at an angle for efficient overspray capture.

- High quality construction made in the UK, all BenchVent filtration and extraction systems carry a lifetime guarantee and are fully CLEAPSS compliant.
- Designed to be quiet in operation and can be assembled in seconds.
- Filter unit with integral fan(s) in a hooded enclosure, particulate filter and charcoal impregnated fibre filter.
- The workstation hood also accommodates prototypes, models, ceramic parts, PCB's etc, placed onto the hood base to be sprayed, soldered, cleaned, glued, moulded, sanded etc.
- Available in either A2 or A1 sizes.

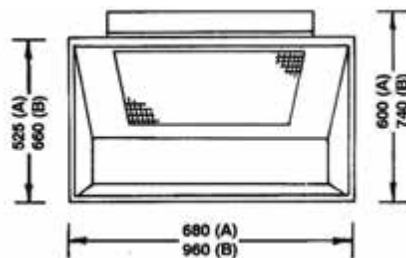
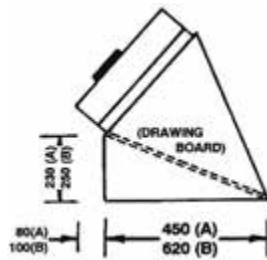

A Dimensions - BV200H B Dimensions - BV100H

CODE	Description	Unit	1+
BVT200HFC	BV200H	1	<b>795.00</b>
BVT100HFC	BV100H	1	<b>1150.00</b>

## BenchVent Extraction Unit BV200H-D/BV100H-D



These cabinets are designed for cleanliness and for immediate operator protection. Large particulates (> 5 microns) are filtered out and 'fine' particulates (<5 microns) together with odours, gases, vapours and fumes within the hood enclosure are exhausted to atmosphere via the flexi-duct(s). Flexi-ducts can be fixed to a standard domestic vent(s) or simply placed through a partially open window. Ideal for applications involving aerosol adhesives, lacquers, airbrush sprays and solder fumes. Drawing boards can be placed into the hood at an angle for efficient overspray capture.

- High quality construction made in the UK, all BenchVent filtration and extraction systems carry a lifetime guarantee and are fully CLEAPSS compliant.
- Quiet in operation and can be assembled in seconds.
- Integral fan(s), particulate filter and 2m hoses.
- The workstation hood also accommodates, models, ceramic parts, PCB's etc, placed onto the hood base to be sprayed, soldered, cleaned, glued, moulded, sanded etc.
- Available in either A2 or A1 sizes.

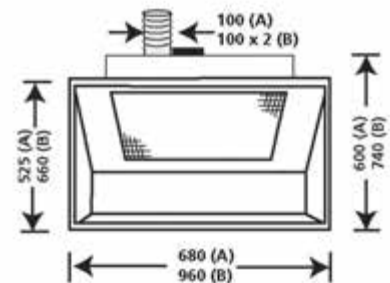
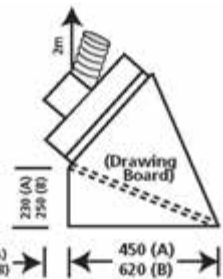

A Dimensions - BV200H-D B Dimensions - BV100H-D

CODE	Description	Unit	1+
BVT200DEC	BV200H-D	1	<b>995.00</b>
BVT100DEC	BV100H-D	1	<b>1350.00</b>

The particulate (intake) filter is a three stage graduated fibre filter with a high 'dust' holding capacity for long life. Filtration to 5 micron particles. NB: Spray particulate sizes vary from 10 to 20 microns. The carbon impregnated fibre filter (behind intake) assists in the reduction of solvent odours. Through the process of filtration, adsorption and dilution, operator exposure to potentially hazardous substances is vastly reduced.

Demonstrating adequate control of the risks to the health of employees, students and the general public, from dusts, powders, mists, fumes and vapours is the fundamental requirement of the Control of Substances Hazardous to Health (CoSHH).

## Strip Heater 500



Please contact us for latest deals

- Strip heater, with a single, guarded heating wire and one power setting.
- Working length is 500mm.
- Suitable for heating materials from 1mm - 5mm in thickness. Calibrated side fences allow easy referencing for accurate and repeatable folding.

CODE	Description	Unit	1+
CRC500SHT	Strip Heater 500	1	<b>439.95</b>

## CR Clarke Hot Wire Strip Heater 600, 1000 or 1500



- These units have two wires which are adjustable for spacing and air gap, allowing materials from 0.5 to 8mm to be processed.
- Hinged upper beam holds the material in position during the heating cycle.
- Calibrated work stop allows the user to accurately set the bend position.
- Fast warm-up and cool-down with a safety switch to de-energise the heating wire when the upper beam is opened.
- Available in three working lengths – 600, 1000 and 1500mm.

CODE	Description	Unit	1+
CRC600SHT	Strip Heater 600	1	<b>625.00</b>
CRC100SHT	Strip Heater 1000	1	<b>979.95</b>
CRC150SHT	Strip Heater 1500	1	<b>1471.25</b>

## CR Clarke Double Hot Wire Strip Heater 600D, 1000D or 1500D



- These units have two wires at the rear of the work table, with a further two mounted in the hinged upper channel, which are adjustable for spacing and air gap, allowing materials from 0.5 to 10mm to be processed.
- Hinged upper beam holds the material in position during the heating cycle.
- Calibrated work stop allows the user to accurately set the bend position.
- Fast warm-up and cool-down with a safety switch to de-energise the heating wire when the upper beam is opened.
- Available in three working lengths – 600, 1000 and 1500mm.

CODE	Description	Unit	1+
CRC600DHT	600D	1	<b>1019.50</b>
CRC100DHT	1000D	1	<b>1374.75</b>
CRC150DHT	1500D	1	<b>1970.00</b>

## CR Clarke Folding Jig 600, 1000 or 1500

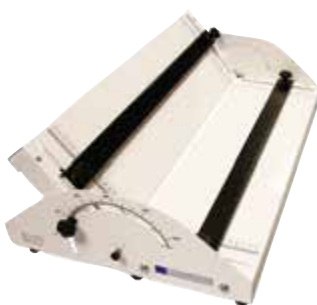

- Folding jigs assist in the quick and accurate setup for any fabrication job.
- Tables are hinged to allow folds from acute to obtuse to be formed, and are calibrated for repeatability.
- Work stops on both tables enable material to be securely located, improving accuracy and consistency.
- Available in three working lengths – 600, 1000 and 1500mm

CODE	Description	Unit	1+
CRC600FDJ	Folding Jig 600	1	<b>178.50</b>
CRC100FDJ	Folding Jig 1000	1	<b>208.75</b>
CRC150FDJ	Folding Jig 1500	1	<b>238.95</b>

## CR Clarke Hot Wire Sculptor/Strip Heater 180

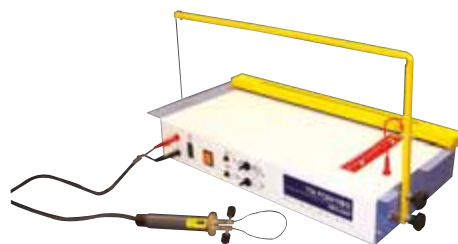

- The 180 is capable of 3 different operations.
- A heated wire on a tensioned bow, ideal for cutting expanded polystyrene models.
- A horizontal wire for strip heating of rigid plastic materials.
- A sculptor tool with wire that can be bent to the required shaped for freehand gouging and channelling work.
- Compact unit, ideal for smaller workshops.

CODE	Description	Unit	1+
CRC180HWS	Sculptor/Strip Heater 180	1	<b>649.50</b>

## Formech Line Bender FLB500



- The FLB 500 has an incoloy heating element over a width of 500mm.
- Easy to use.
- Material clamp to prevent bowing and to aid bend accuracy and temperature regulator.
- Power 250W/240V.
- Sold with a dedicated cooling jig designed to maintain the desired angle of the heat bent plastic whilst cooling.

CODE	Description	Unit	1+
FRM500LBR	FLB500	1	<b>585.00</b>

## Formech Line Bender FLB1000



- The FLB 1000 model has an effective quartz element providing broad spread of heat means strong consistent bends are achieved rapidly.
- Material clamp to prevent bowing and to aid bend accuracy and temperature regulator.
- Timer and alarm for reliably bending batches of the same material.
- Power 750W/240V.
- Sold with a dedicated cooling jig designed to maintain the desired angle of the heat bent plastic whilst cooling.

CODE	Description	Unit	1+
FRM100LBR	FLB1000	1	<b>1395.00</b>

### WORKPLACE

## Heat Resistant Gloves



## Vacuum Former 1210



Please contact us for latest deals

- Simple bench top machine with ceramic heater system and high performance vacuum pump.

Specification	
Sheet size	305 x 228mm
Max. material thickness	6mm
Max. mould height	115mm

CODE	Description	Unit	1+
CRC121VAF	Vacuum Former 1210	1	<b>1999.00</b>
CRC122VAF	1210 Stand/Trolley	1	<b>249.95</b>

## Vacuum Former 725FLB



Please contact us for latest deals

- Multi-zone ceramic heater system.
- Digital timer with audible end of cycle alarm.
- Bench mounted, optional stand with castors.

Specification	
Sheet size	458 x 254mm
Max. material thickness	6mm
Max. mould height	152mm

CODE	Description	Unit	1+
CRC725VCF	Vacuum Former 725FLB	1	<b>3299.00</b>
CRC726VCF	725 Stand/Trolley	1	<b>278.50</b>

## Vacuum Former 750



Please contact us for latest deals

- Maximum mould height 150mm.
- Four zone ceramic heater system.
- High flow vacuum pump.
- Digital timer with audible alarm.
- Comes complete with stand with locking castors.

Specification	
Sheet size	508 x 458mm
Max. material thickness	6mm
Max. mould height	152mm

CODE	Description	Unit	1+
CRC750VAF	Vacuum Former 750	1	<b>5495.00</b>

## Formech Compac Mini Vacuum Former



Please contact us for latest deals

- Energy efficient Quartz heaters ensure the Compact Mini is ready for action within a few minutes.
- Formech's interlocking feature prevents the table being raised whilst in the forward position.
- Compac Mini Trolley optional.

Specification	
Material size	300 x 250mm
Forming area	280 x 230mm
Max. depth of draw	130mm
Max. material thickness	4mm
Zones	1
Heaters	Quartz
Dimensions W x H x D	490 x 427 x 810mm
Weight	33kg
Electrical specifications	230V, 0.75kW
Phase	Single

CODE	Description	Unit	1+
FRM200VAF	Vacuum Former Compac	1	<b>2060.00</b>
FRM200TLY	Compac Stand/Trolley	1	<b>310.00</b>

## Formech 450DT Vacuum Former



Please contact us for latest deals

- The 450DT (which replaces the 300XQ) features a high resolution digital PLC and touchscreen for convenient and precise control.
- Graphically driven display with easy to understand icons provide intuitive control whilst a 20-program memory allows user to conveniently store and recall projects.
- A world's best-seller, Formech's 300XQ has built an unmatched reputation for professional performance at an affordable price.
- Evolution to the 450DT offers today's students, designers and inventors the latest user experience with industry standard control technology.

### Key Features

- Quartz Heaters with Variable Standby, 4 Independently Controllable Heating Zones, Vacuum and Release with a Vacuum Gauge.

CODE	Description	Unit	1+
FRM450VAF	Vacuum Former 450DT	1	<b>3305.00</b>
FRM450TLY	450 Stand/Trolley	1	<b>330.00</b>

## Formech 508DT Vacuum Former



Please contact us for latest deals

- Featuring the very latest vacuum forming technologies, Formech's highly capable 508 series features a level of specification typically reserved for much larger, more expensive machines.
- Intuitive touch-screen, Programmable Logic Control (PLC) with multiple memory function provides incredible convenience and rapid adaptation.
- The unique touch-screen graphics offer a truly bespoke user experience.
- A depth of draw up to 290mm makes the 508 series applicable to the most challenging applications.

Specification	
Material size	508 x 457mm
Forming area	482 x 432mm
Max. depth of draw	185mm
Max. material thickness	6mm
Zones	1
Heaters	Quartz
Dimensions W x H x D	597 x 560 x 1100mm
Weight	100kg
Electrical specifications	230V, 2.3kW
Phase	Single

CODE	Description	Unit	1+
FRM508VAF	Vacuum Former 508DT	1	<b>5280.00</b>
FRM508TLY	508DT Stand/Trolley	1	<b>335.00</b>



## Gerbil Vacuum Form Trimming 2010



Please contact us for latest deals

- 0.07kw motor, 230V/1ph/50Hz, 1380rpm.
- 400 x 455mm MDF table top.
- Tungsten carbide abrasive disc for vacuum form trimming- safe to touch even while running.
- Tool height adjustment facility with multiple tool arbor.
- No-volt release switch.

CODE	Description	Unit	1+
GER201STD	2010	1	<a href="#">See Website</a>

## Gerbil Vacuum Form Trimming 2020



Please contact us for latest deals

- As for the Gerbil 2010 plus these additional features.
- Adjustable 0° to 10° metal tilting table.
- Adjustable guide fence.
- Large diameter hand wheel for tool height adjustment. Dust extracting fence incorporating tool guard.
- A Full Tool Kit featuring the following:
  - Tungsten carbide abrasive disc and holder
  - Tungsten carbide and cutter
  - Two flap wheels for general de-burring
  - Finishing and polishing mops and compounds.

CODE	Description	Unit	1+
GER202PLS	2020	1	<a href="#">See Website</a>

## Gerbil Vacuum Form Trimming 2030



Please contact us for latest deals

- As for the Gerbil 2020 PLUS
- Gerbil Trolley featuring: 360° swivel castors, 2 with breaks, rimmed top surface with non-slip mat.
  - Robust metal design with shelving to hold and store tools and equipment.
  - A Drum Sander with template, for creating draft angles on wooden vacuum form moulds.

CODE	Description	Unit	1+
GER203PRO	2030	1	<a href="#">See Website</a>

## Profile Cutter 145

Please contact us for latest deals



- Trims light gauge vacuum forming up to 3mm thick easily, safely and quickly.
- Combined adjustable and robust fence/guard for trimming fine details with flanges from 0 to 6 mm without changing tooling.
- Industrial single phase, balanced and fan cooled motor.
- Swarf collection duct for connection to an existing extraction unit (not essential to operation).
- Angled work support table.
- Foot switch operated for safety, allowing both hands to control the work during cutting.

CODE	Description	Unit	1+
CRC145PFC	Profile Cutter 145	1	<b>889.00</b>

## C R Clarke Hot Wire Sculptor 280



- The 280 has a fine heating wire capable of cutting expanded polystyrene materials up to 250mm in thickness.
- Variable power to the wire is supplied from the low voltage transformer housed in the base of the machine.
- The sculptor tool with wire that can be bent to the required shaped for freehand gouging and channelling work.
- The machine must always be used in a well ventilated area, but a foot pedal switch minimising any fumes, removing the need for dedicated extraction.

CODE	Description	Unit	1+
CRC280HWS	Hot Wire Sculptor 280	1	<b>737.50</b>

## Fan Circulated Oven 200FD

Please contact us for latest deals



- Ideal for heating materials prior to dip coating, dome blowing, press forming and thermoforming.
- Also suitable for pre-drying materials prior to vacuum forming.
- Capable of heating materials up to 300°C.
- Fitted with digital temperature controllers and high quality insulation for optimum energy efficiency.

CODE	Description	Unit	1+
CRC200OVN	Fan Circulated Oven	1	<b>1729.00</b>
CRC201OVN	Stand for Oven	1	<b>307.95</b>

## CR Clarke Schredder Plastic Granulator R25 Single or 3 Phase



- Industrial plastic granulator for recycling materials such as PP, HIPS, ABS and LDPE.
- Combination of static and rotating blades gradually chops the material until it's small enough to pass out through a mesh filter into the collection bin.
- A separate Sheet Press is required to form the granules into a sheet for use.
- Available in 1ph or 3ph.

CODE	Description	Unit	1+
CRC251SCH	R25 Single Phase	1	<b>6225.00</b>
CRC253SCH	R25 3 Phase	1	<b>5757.50</b>

## CR Clarke Schred Sheet Press R30



- Converts granulated thermoplastic material into a usable form using heat and pressure.
- The resultant flat plastic sheet can typically be used for vacuum forming, laser cutting, line bending etc.
- Removable material cassette is loaded with granules, which is clamped firmly between two temperature controlled aluminium hotplates to soften and fuse the sheet.
- Produces a sheet size that is suitable for the 725FLB Vacuum Former.
- Other sizes of material can be produced using separately available heating trays.

CODE	Description	Unit	1+
CRC301SPR	Sheet Press R30	1	<b>4060.00</b>
CRC301STN	Stand	1	<b>475.00</b>

## CR Clarke Plastic Dip Coating Kit 120K



Please contact us for latest deals

- Kit comprises Blower Unit 120, Large Fluidising Bath300, Small Fluidising Bath150 and Trolley 300S.
- The CR Clarke Dip Coating system comprises of a variable speed low pressure blower unit, large dip tank, small dip tank and a mobile stand.
- The larger bath has internal dimensions of 300 x 300 x 600mm.
- For smaller objects or separate colours, the 150 bath can be clamped directly to the top of the 300, giving a 150 x 150 250mm tank.
- All mounted on a mobile stand.

CODE	Model	Unit	1+
CRC120KIT	Dip Coating Kit	1	<b>1325.00</b>

## CR Clarke Dip Coating 150 Fluidised Bath



- A smaller fluidising bath designed to be clamped to the top of the 300 as an additional bath. dipping smaller items or if a different colour coating is required.
- Ideal for dipping smaller items or when a different colour coating is required.
- Maximum object size: 125 x 125 x 175mm.

CODE	Model	Unit	1+
CRC150FBH	Fluidised Bath 150	1	<b>179.50</b>

## CR Clarke Dip Coating 300 Fluidised Bath



- The porous membrane in the floor of the bath allows low-pressure, high-volume air to be blown into the powder in the tank to aerate the powder.
- Membranes have a protective mesh in case a hot metal item is dropped in the Bath.
- Manufactured from powder coated steel.
- Maximum object size: 270 x 270 x 350mm.
- Overall dimensions: 300 x 300 x 500mm.

CODE	Description	Unit	1+
CRC300FBH	Dip Coating 300	1	<b>327.50</b>

## CR Clarke Dip Coating 120 Blower/Suction Unit



- Incorporates a high-flow, low-pressure blower which is ideal for use with the 300 and 150R Fluidised Baths.
- Manufactured from powder coated steel.
- Inlet and outlet stubs 25mm, allowing it to be used for both vacuum and pressure.
- 230V/5A.

CODE	Model	Unit	1+
CRC120UNT	Dip Coating 120	1	<b>669.95</b>

## CR Clarke Dip Coating 150 Freestanding Fluidised Bath



- Freestanding Fluidised Bath that has a multi-size air inlet in the base.
- Allows for the incoming air to be supplied from the 120 Blower Unit or the pressure outlet from a C R Clarke Vacuum Forming Machine. Alternatively a compressed air line fitted with suitable pressure and flow restrictions.
- Built-in flow adjustment allows fine control of the aeration of the powder.
- Maximum object size: 125 x 125 x 175mm.
- Overall dimensions: 245 x 200 x 365mm.

CODE	Model	Unit	1+
CRC150RFB	Fluidised Bath 150	1	<b>179.50</b>

## CR Clarke Dip Coating 300S Stand



- A trolley which will take the individual dip coating equipment units.
- Manufactured from powder coated steel with two wheels for mobility

CODE	Description	Unit	1+
CRC300TLY	Dip Coating 300S	1	<b>179.50</b>

### MACHINES & POWER TOOLS

#### Dip Coating Powder

Dip Coating Powder in 5kg and 20kg - phone for details



## Injection Moulder 25

Please contact us for latest deals



- Provides a clear demonstration of injection moulding principles, whilst producing dense, production quality.
- Mouldings up to 20 grams in weight.
- Temperature controlled heating barrel.
- Rack and pinion ram.
- Supplied with 2kg of Polyethylene granules.

CODE	Description	Unit	1+
CRC025MLD	Injection Moulder 25	1	<b>2229.00</b>

## Thermoforming Centre 911



- Six thermoforming processes in a single machine.
- Two zone ceramic heater system ensures even heating for vacuum forming and also heats the fan circulated oven.
- Rotary switch allows the operator to select the required process.
- Digital timer with audible alarm provides a useful timing guide.
- Dome Blowing - supplied with rings for 305, 225 and 150mm diameter domes.
- Vacuum forming in two sizes: Sheet size 305 x 305mm, aperture size 279 x 279mm and Sheet size 305 x 152mm, aperture size 279 x 127mm. With a maximum mould height 115mm.
- Plastic Dip Coating- a 5 litre tank.
- Injection Moulding- comes complete with two moulds.
- Extrusion- I section nozzle.
- Plastic Welding- Industrial hot air torch.

Please contact us for latest deals

CODE	Description	Unit	1+
CRC911TFC	Thermoforming Centre 911	1	<b>10999.00</b>

### MACHINES & POWER TOOLS

## Moulds and Polyethylene Granules

(red, blue and grey) for Injection Moulders - phone for details.

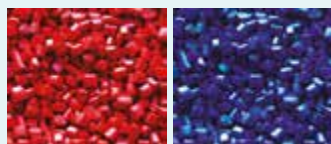

## Proxxon Hot Wire Cutter



- Double wound transformer and insulation to class 2 ensuring electrical safety.
- Cutting wire operates at 10V, 1A.
- Large base with 390 x 280mm table.

CODE	Description	Unit	1+
HWC101THR	Thermocut Hot Wire Cutter	1	<b>115.00</b>
HWC702SWE	Spare Wire Element	1	<b>9.95</b>

## CR Clarke Diamond Edge Polisher 1525



- Converts a sawn edge of plastic material into a high-gloss polish in one operation.
- Uses two diamond cutting tools mounted into a precision balanced steel cutter hub, ensuring minimal vibration even at the maximum cutter speed of 20,000rpm.
- Accommodates thicknesses from 2mm to 25mm.
- Feed rate of 1m per minute.
- Includes an extraction unit beneath the polisher.

CODE	Description	Unit	1+
CRC152DEP	1525	1	<b>11350.00</b>

## Antelope & Deer Bandfacers



Please contact us for latest deals

- Designed to meet strict performance and safety criteria and are ideal for use in school and colleges.
- Suitable for working on wood, acrylic or metal.
- Bench, pedestal or dust extraction mounted.
- Quick action calibrated tilting table for operating positions between 90 and 135 degrees.
- Adjustable protractor guide.
- Supplied with one aluminium oxide abrasive belt.

### Safety Features:

- Fully guarding including adjustable front belt guard for maximum finger protection.
- No-volt overload push-button controls.
- Additional stops on the pedestal and extraction versions.

Specification	
Motor	1.25kw (400V3ph/50Hz) or 0.70kw (230V/1ph/50Hz)
Extractor	0.55kw
Abrasive belt	150 x 1090mm
Belt speed	6.5m/sec
Table	278 x 226mm

CODE	Description	Unit	1+
DER151BNC	Deer Bench 1ph	1	<a href="#">See Website</a>
DER153BNC	Deer Bench 3ph	1	<a href="#">See Website</a>
DER151PED	Deer Pedestal 1ph	1	<a href="#">See Website</a>
DER153PED	Deer Pedestal 3ph	1	<a href="#">See Website</a>
ANT151EXT	Antelope Extraction 1ph	1	<a href="#">See Website</a>
ANT153EXT	Antelope Extraction 3ph	1	<a href="#">See Website</a>

## Holzkratt Wetstone Grinder NTS200



- A low speed grinder with a shatterproof water bath, this enables grinding without the loss of tool hardness.
- Powerful induction motor for quiet and vibration-free working, 120W 240V.
- Grinding stone 200 x 40 mm.
- Supplied with AngleMaster Gauge, Universal Grinding Jig, Leather Honing Wheel and Honing Paste.
- Robust moulded housing with splash proof switch and motor.
- 9.2kg.

CODE	Description	Unit	1+
HLZ200WGR	NTS200	1	<b>159.50</b>

## Holzkratt Wetstone Grinder NTS255



- A professional low speed grinder with a shatterproof water bath. No more over heating cutters and running the temper!
- Powerful induction motor for quiet and vibration-free working, 200W 240V.
- Grinding stone 250 x 50 mm.
- Supplied with AngleMaster Gauge, Universal Grinding Jig, Leather Honing Wheel and Honing Paste.
- Powder coated steel housing with a splash proof switch and motor.
- 17kg.

CODE	Description	Unit	1+
HLZ255WGR	NTS255	1	<b>245.00</b>

## Holzkratt Honing Paste



- For use with the leather honing wheels.
- Produces a highly polished finish for a razor edge.
- Tube of 75ml.

CODE	Description	Unit	1+
HLZ075PST	Honing Paste	1	<b>14.50</b>

## Holzkratt Stone Grader



- Double sided abrasive stone to grade the wetstone.
- The fine side embeds particles in the stone to produce a fine finished edge.
- The coarse side lifts out the fine grit to restore the wheel to its original grade.

CODE	Description	Unit	1+
HLZ820SGR	Stone Grader	1	<b>22.95</b>

## Holzkratt Wetstone Wheel



- Special stone compound containing aluminium oxide for perfect grinding results even with hard steel over 60 HRC (tool steel).
- HLZ200WHL 200 x 40mm with 12mm bore.
- HLZ255WHL 250 x 50mm with 12mm bore.

CODE	Description	Unit	1+
HLZ200WHL	200mm	1	<b>44.95</b>
HLZ255WHL	250mm	1	<b>85.00</b>

## Bear Toolgrinder

Please contact us for latest deals



- Controlled 140rpm wheel speed.
- Force-fed recirculation coolant system with anti-spill tray.
- Tool holder for chisels and plane blades up to 60mm wide.
- Centre swivel arm with vernier adjustment to ensure square and even contact between the tool and the wheel.
- Supplied with one Aluminium Oxide A80 grinding wheel.

**Safety features:**

- No-volt overload push-button starter.

Specification	
Motor	0.18kw (400V/3ph/50Hz) or 0.25kw (230V/1ph/50Hz)
Grinding wheel	406Ø x 32mm

CODE	Description	Unit	1+
BEA401GRD	Bear Toolgrinder 1ph	1	<a href="#">See Website</a>
BEA403GRD	Bear Toolgrinder 3ph	1	<a href="#">See Website</a>

## Optimum Drill Sharpener GQ-D13



- Robust plastic housing with non-slip feet.
- Diamond grinding stone for durability.
- Sharpens drills from 3mm to 13mm.

Specification	
Motor	80W/230V
Dimensions L x W x H	200 x 200 x 160mm

CODE	Description	Unit	1+
OPT150DSH	Drill Sharpener	1	<b>79.50</b>
OPT150WHL	Replacement Wheel	1	<b>22.95</b>

## Chamois Polisher

Extraction



Pedestal



Bench

- Designed to meet strict performance and safety criteria and is ideal for use in schools and colleges.
- Bench, pedestal or dust extraction mounted.
- Taper adaptors for use with polishing mops, finishing wheels or wire brushes.
- Heavy duty adjustable polycarbonate eye shields.
- Supplied with two mops - one loose leaf and one stitched calico.
- 1500rpm suitable for plastics

**Safety features:**

- No-volt overload push-button controls.
- Motor thermal overload protection.
- Additional stops on the pedestal and extraction version.

Specification	
Motor	1.5 (400V/3ph/50Hz) or 0.75kw (230V/1ph/50Hz)
Extractor	0.55kw
Mops	200 x 25mm

CODE	Description	Unit	1+
CHM221PED	Pedestal 1ph	1	<a href="#">See Website</a>
CHM223PED	Pedestal 3ph	1	<a href="#">See Website</a>
CHM221EXT	Extraction 1ph	1	<a href="#">See Website</a>
CHM223EXT	Extraction 3ph	1	<a href="#">See Website</a>
CHM221BNC	Bench 1ph	1	<a href="#">See Website</a>
CHM223BNC	Bench 3ph	1	<a href="#">See Website</a>

## Gryphon Grinder

Please contact us for latest deals



- Designed to meet strict performance and safety criteria, and is ideal for use in schools and colleges.
- Bench, pedestal or dust extraction mounted.
- Adjustable, non-tip cast-iron work rests.
- Spark arrestors.
- Heavy duty adjustable polycarbonate eye shields.
- Supplied with two grinding wheels, one coarse and one fine.

**Safety features:**

- No-volt overload push-button controls.
- Motor thermal overload protection.
- Additional stops on the pedestal and extraction versions.

Specification	
Motor	0.85kw (400V/3ph/50Hz) or 0.70kw (230V/1ph/50Hz)
Grinding wheels	200 x 25 x 20mm

CODE	Description	Unit	1+
GRY201PED	Pedestal 1ph	1	<a href="#">See Website</a>
GRY203PED	Pedestal 3ph	1	<a href="#">See Website</a>
GRY201EXT	Extraction 1ph	1	<a href="#">See Website</a>
GRY203EXT	Extraction 3ph	1	<a href="#">See Website</a>
GRY201BNC	Bench 1ph	1	<a href="#">See Website</a>
GRY203BNC	Bench 3ph	1	<a href="#">See Website</a>

## OPTIMUM Bench grinder



- Heavy duty industrial maintenance-free motor for continuous use.
- Unbreakable extruded aluminium housing.
- Balanced spindle with quality bearings ensuring very smooth running.
- Spark protection guards on each grinding wheel.
- Solid, adjustable work support.
- Vibration-absorbing rubber feet.

Specification	GU 15	GU 20
Electrical Connection	230 V / 1 Ph ~ 50 Hz	230 V or 400V
Motor Power	450 W	600 W
Wheel Dimensions	Ø150 x 20 Ø16 mm	Ø200 x 30 Ø32 mm
Speed	2850 min <sup>-1</sup>	2850 min <sup>-1</sup>
L x W x H	465 x 316 x 302 mm	510 x 354 x 332 mm
Net Weight	10.7kg	18.5kg

CODE	Description	Unit	1+
OPT150BGR	150mm/1ph	1	<b>189.50</b>
OPT201BGR	200mm/1ph	1	<b>259.50</b>
OPT203BGR	200mm/3ph	1	<b>285.00</b>

## Berghmann Bobbin Sander



- Large 370 x 295mm cast iron table for stability and enhanced material support.
- Enables precise finishing of intricate work and includes 6 standing sleeves 13-76mm diameter with matching drum and table inserts.
- On-board storage for all accessories.
- Dust port for connection to extraction system.

CODE	Description	Unit	1+
OCS450SET	Bobbin Sander	1	<b>159.50</b>

### Sanding Sleeves

CODE	Description	Unit	1+
OCS080SLV	80 Grit - Assorted	Pack of 6	<b>14.25</b>
OCS150SLV	150 Grit - Assorted	Pack of 6	<b>14.25</b>
OCS240SLV	240 Grit - Assorted	Pack of 6	<b>14.25</b>

## Berghmann Disc Sander



- For use in educational establishments and manufactured according to CE standard.
- Braking system stops the powerful motor 550W/230V within 10 seconds.
- No-volt release switch positioned on the top of the machine with a latch type emergency stop.
- Sanding disc Ø 305 mm with a robust tilting cast iron table.
- Minimal gap between disc and table with an additional guard on the right-hand quadrant, reducing the disc exposure to zero.
- Dust extraction port 63mm and full disc cover beneath the table.

CODE	Description	Unit	1+
DSD305BMT	Disc Sander	1	<b>425.00</b>

## Optimum Drilling Machine DQ14



- Safety electrics in 24 V DC voltage and front mounted emergency stop.
- Robust table can be rotated and inclined.
- One-piece die-cast aluminium quill lever with soft-grip handles.
- Gates quality V-belt drive - 5 speeds.

Specification	
Motor power	350W (230V/1ph)
Drilling cap. in steel (S235JR)	13mm
Throat depth	104mm
Spindle stroke	52mm
Spindle speeds	700 - 2520 min <sup>-1</sup>
Drilling table	170 x 170mm
Column diameter	46mm
Length x width x height	472 x 283 x 634mm
Net weight	18.5kg
Standard equipment	Keyless chuck 1-13mm

CODE	Description	Unit	1+
OPT140DBD	DQ 14	1	<b>255.00</b>

SEE WORKHOLDING PAGES 170-171

## Drilling Machine Vices



## Optimum Drilling Machine DQ18



- Safety electrics in 24 V DC voltage and front mounted emergency stop..
- Robust table can be rotated and inclined - with t-slots.
- One-piece die-cast aluminium quill lever with soft-grip handles.
- Gates quality V-belt drive - 5 speeds.

Specification	
Motor power	450W (230V/1ph)
Drilling cap. in steel (S235JR)	16mm
Throat depth	127mm
Spindle stroke	65mm
Spindle speeds	600 - 2400 min <sup>-1</sup>
Drilling table	200 x 200mm
Column diameter	60mm
Length x width x height	568 x 319 x 849mm
Net weight	28.5kg
Standard equipment	Keyless chuck 1-16mm

CODE	Description	Unit	1+
OPT180DBD	DQ 18	1	<b>450.00</b>

## Optimum Drilling Machine D17 Pro

- Full educational specification with interlocked drill guard, micro switched V-belt cover, no-volt release switching, emergency stop button.
- Integrated display showing both the speed and drilling depth.
- One-piece aluminium handwheel with soft gripped handles.



Specification	
Motor power	500W (230V/1ph)
Drilling cap. in steel (S235JR)	16mm
Throat depth	152mm
Spindle stroke	65mm
Spindle speeds (5)	680 - 2700min <sup>-1</sup>
Drilling table	235 x 220mm
Column diameter	60mm
Length x width x height	565 x 275 x 840mm
Weight	39.50kg
Standard equipment	Keyless chuck 1-16mm

CODE	Description	Unit	1+
OPT170DBD	D17/1ph	1	<b>675.00</b>

## Optimum Drilling Machine D23 Pro

- Full educational specification with interlocked drill guard, micro switched V-belt cover, no-volt release switching, emergency stop button.
- Integrated display showing both the speed and drilling depth.
- One-piece aluminium handwheel with soft gripped handles.



Specification	
Motor power	750W
Drilling cap. in steel (S235JR)	25mm
Throat depth	180mm
Spindle stroke	80mm
Spindle speeds (5)	200 - 2440min <sup>-1</sup>
Drilling table	280 x 245mm
Column diameter	73mm
Length x width x height	615 x 330 x 1015mm
Weight	58kg
Standard equipment	Keyless chuck 1-16mm

CODE	Description	Unit	1+
OPT231DBD	D23/1ph	1	<b>895.00</b>
OPT233DBD	D23/3ph	1	<b>950.00</b>

## Optimum Drilling Machine D26 Pro

- Full educational specification with interlocked drill guard, micro switched V-belt cover, no-volt release switching, emergency stop button and foot stop.
- Integrated display showing both the speed and drilling depth.
- One-piece aluminium handwheel with soft gripped handles.



Specification	
Motor power	750W
Drilling cap. in steel (S235JR)	25mm
Throat depth	210mm
Spindle stroke	85mm
Spindle speeds (5)	200 - 2440min <sup>-1</sup>
Drilling table	330 x 290mm
Column diameter	73mm
Length x width x height	670 x 355 x 1640mm
Weight	85kg
Standard equipment	Keyless chuck 1-16mm

CODE	Description	Unit	1+
OPT261DFD	D26/1ph	1	<b>1095.00</b>
OPT263DFD	D26/3ph	1	<b>1150.00</b>

## Optimum Drilling Machine D33 Pro

- Full educational specification with interlocked drill guard, micro switched V-belt cover, no-volt release switching, emergency stop button and foot stop.
- Integrated display showing both the speed and drilling depth.
- One-piece aluminium handwheel with soft gripped handles.



Specification	
Motor power	1100W
Drilling cap. in steel (S235JR)	30mm
Throat depth	254mm
Spindle stroke	120mm
Spindle speeds (5)	120 - 1810min <sup>-1</sup>
Drilling table	475 x 425mm
Column diameter	92mm
Length x width x height	755 x 440 x 1705mm
Weight	132kg
Standard equipment	Keyless chuck 1-16mm

CODE	Description	Unit	1+
OPT333DFD	D33/3ph	1	<b>1595.00</b>

## Optimum Precision Drilling Machine DX15V



- Infinitely variable speed 100 - 3,000rpm with digital display.
- Drill spindle with precision ball bearings and guaranteed concentricity accuracy  $\leq 0.03$  mm.
- Prominent stop switch and interlocked height-adjustable guard.
- High quality keyless chuck with 2MT fitting.

Specification	
Motor	0.85kW 230V/1ph
Drilling capacity in steel	15mm
Dimensions L x W x H	481 x 475 x 980mm
Weight	66kg

CODE	Description	Unit	1+
OPT150VTD	DX15V	1	<b>1495.00</b>
OPT160BAS	Machine Base	1	<b>220.00</b>

## Optimum Precision Tapping and Drilling Machine DX17V



- Automatically sets the optimum speed for the working modes of drilling and tapping when specifying the drill diameter and the material - variable speeds 50 - 4,000rpm.
- Drill spindle with precision ball bearings and guaranteed concentricity accuracy  $\leq 0.03$  mm.
- Prominent stop switch and interlocked height-adjustable guard.
- High quality keyless chuck with B16 fitting.

Specification	
Motor	1.1kW 230V/1ph
Drilling capacity in steel	16mm
Tapping up to	M8
Dimensions L x W x H	425 x 475 x 980mm
Weight	73kg

CODE	Description	Unit	1+
OPT170VTD	DX17V	1	<b>2335.00</b>

## Meddings Compact 16 Drilling Machines



Please contact us for latest deals



- Supplied complete with chuck and chuck guard as shown.
- Floorstanding model has a integral stop switch in the base casting.

Specification	COMPACT 16 Bench	COMPACT 16 Floor
Drilling capacity in mild steel	16mm	
Motor	0.37kW	
Spindle	2 MT	
Drive	Belt, stepped pulleys	
Spindle speeds rpm 50Hz	500-900-1430-2230-3800	
Spindle travel	100mm	
Throat depth	194mm	
Column diameter	70mm	
Table - working surface	235 x 295mm	
Table - slots width & centres	14 x 150mm	
Base - overall	235 x 409mm	
Base - working surface	235 x 295mm	
Base - slots width & centres	14 x 150mm	
Max distance chuck to table	n/a	1077mm
Max distance chuck to base	294mm	1258mm
Overall height	815mm	1577mm
Overall width		372mm
Overall depth		627mm
Approx nett weight	46kg	61kg
Electrics		1 phase

CODE	Description	Unit	1+
MED160BND	Compact 16 Bench	1	<b>See Website</b>
MED160FSD	Compact 16 Floor	1	<b>See Website</b>

## Meddings L1 and L2 Drilling Machines



Please contact us for latest deals



- Industrially rated drilling machines developed over many years to give reliable use.
- L2 models featuring a two speed motor to extend the available speed range.
- Rack and pinion table adjustment.
- 2 MT spindles with increased drilling capacities.
- Floor standing machine are fitted with integral stop switches.
- All machines are supplied complete with chuck guards as illustrated. Chucks are extra.

Specification	LB1/V Bench	LF1/V Floor	LB2/III Bench	LF2/III Floor
Drilling capacity in mild steel	18mm	18mm	23mm	23mm
Motor	0.45kW		0.45/0.75kW (2 speed)	
Spindle	2 MT			
Drive	Belt, stepped pulleys			
Spindle speeds rpm 50Hz	400-700-1200-2100-3600		200-350-400-600-700-1050-1200-1800-2100-3600	
Spindle travel	75mm			
Throat depth	185mm			
Column diameter	70mm			
Table - working surface	250x164mm			
Table - slots width & centres	13x125mm			
Base - overall	240x360mm	357x523mm	240x360mm	357x523mm
Base - working surface	n/a			
Base - slots width & centres	n/a			
Max distance chuck to table	330mm	740mm	330mm	740mm
Max distance chuck to base	n/a			
Overall height	865mm	1710mm	865mm	1710mm
Overall width	280mm			
Overall depth	600mm			
Approx nett weight	77kg	133kg	84kg	140kg
Electrics	1 phase		3 phase	

CODE	Description	Unit	1+
MED181BND	L1 Bench	1	<b>See Website</b>
MED181FSD	L1 Floor Standing	1	<b>See Website</b>
MED232BND	Meddings LB2/III*	1	<b>See Website</b>
MED232FSD	Meddings LF2/III**†	1	<b>See Website</b>

\* (chuck not included) † (floor standing)



## Baileigh Industrail Drill Press 1000VS



- Variable Speed 1000 VS.
- An industrial Drill Press with variable speeds and very rigid due to heavy duty casting.
- Inverter driven head allows the operator to run tooling at exact running speeds, extending tool life and reducing breakage.
- Complete with a coolant system, safety guarding and a halogen light.

Specification	
Motor	1.5kW, 220v 1-ph
Drilling capacity in steel	25mm
Spindle speed	1000VS: 185 - 2500 rpm
Tapping	Auto-reverse

CODE	Description	Unit	1+
BAL100DPV	1000 VS	1	<b>3350.00</b>

## Baileigh Industrail Drill Press 1250VS 1250VS-HS



- Variable Speed 2500VS and High Speed 1250VS-HS.
- An industrial range of Drill Press with variable speeds and very rigid due to the heavy duty castings. Available in two models with the HS having a variable high speed of 0 - 4000rpm.
- Inverter driven head allows the operator to run tooling at exact running speeds, extending tool life and reducing breakages.
- Complete with a coolant system, safety guarding and a halogen light.

Specification	12500VS	1250VS-HS
Motor	1.5W 220V 1-ph	
Drilling capacity	25mm	
Spindle speed	High range 245 - 2000 rpm Low range 65 - 540 rpm	0 - 4000 rpm
Tapping	Auto-reverse	

CODE	Description	Unit	1+
BAL125DPV	1250 VS	1	<b>4250.00</b>
BAL125DPH	1250 VS-HS	1	<b>4700.00</b>

## Sedgwick Mortiser 571



Please contact us for latest deals



- Cast iron base, column, table and slideways provides a rigid and durable mainframe.
- 1" chisel capacity via 1.5Hp industrial rated motor.
- Fully guarded ½" adjustable chuck for holding the bit.
- Single hand wheel control to longitudinal and lateral table movements.
- All slide movements are easily adjusted by a single dovetail slide for ease of maintenance.
- Switchgear has no-volt release, thermal overload, and a mushroom headed stop button.

Specification	
Timber capacity H x W	255 x 180mm
Stroke of chisel head	125mm

CODE	Description	Unit	1+
SDG571SNP	Mortiser 571 1ph	1	<b>See Website</b>
SDG571THP	Mortiser 571 3ph	1	<b>See Website</b>

## Bench Mounted Machinery Unit



- Complete unit that incorporates a bench and dust extraction.
- The most common unit are the Fretsaw Units which are very competitively priced- these can include any model of fretsaw including Hegner.
- Strong steel framed bench has a purpose built extraction system which features an automatic switching function - extraction unit switches in unison with the bench mounted machine.
- High quality components manufactured in the UK for Tilgear.
- Options such as additional emergency stops, castors, steel tops are all available on request.
- Please contact us for a competitive quote.

## Berghmann Scroll Saw Pro



- Heavy duty cast iron construction to minimise vibration and the double arm parallel action gives a clean vertical cut.
- Fitted with a variable speed NVR starter, eye shield and work hold down foot with a finely ground large cast iron table that can be tilted to 45°.
- Takes pinned or plain end blades with a 65mm depth of cut.
- Articulated hose provides a dust free cutting area, plus an extractor port below the table.
- A powerful 120W induction motor runs quietly with variable speeds of 400 to 1,400 strokes per minute.

CODE	Description	Unit	1+	1+
SRS650PRO	120W	1	<b>575.00</b>	595.00

## Scroll Saw Blade Clamp Pair



- Blade clamps for holding un-pinned blades, suitable for most scroll saws.
- Available with a slot size of either 0.5mm (for fine blades) or 0.7mm (for general use).
- Supplied as a pair.

CODE	Description	Unit	1+
SRS005CLM	0.5mm	Pair	<b>7.95</b>
SRS007CLM	0.7mm	Pair	<b>7.95</b>

## Holzstar 504 Scroll Saw



- Robustly constructed with a variable speed control.
- Work table tilts from 0 to 45 degrees.
- Flexible LED light and integral blower.
- Includes a high speed rotary tool attachment.
- Dust extraction port.

Specification	
Max cutting height	52mm
Number of strokes	550 - 1600 per min
Motor power	90W / 230V
Weight	12kg

CODE	Description	Unit	1+
SRS504VAR	504	1	<b>199.00</b>

Bandsaws

## Holzkratt Industrial Bandsaw HBS 533



- Heavy professional for maximum rigidity.
- Large cast iron table with a polished surface.
- Precise saw blade roller guiding.
- Large grey cast iron parallel fence.
- Rapid and precise adjustment of cutting height via hand wheel.
- Interlock switches on the door.
- Mitre guide included.

Specification	HLZ533PBS
Working table dimensions	750 x 530 mm
Cutting speeds	1400 m/min
Flywheel Ø	530mm
Max. cutting height	350mm
Max. cutting width with stop	465mm
Max cutting width without stop	510mm
Saw belt length	4190mm
Precision guiding 3 rolls	Top / Bottom
Saw bench inclination	0 - +45°*
Motor power	3.75kW/3ph
Weight	305kg
Dimensions L x W x D	1000 x 720 x 2040mm
Suction nozzle diameter	2 x 100mm

CODE	Description	Unit	1+
HLZ533PBS	Industrial Bandsaw	1	<b>2950.00</b>

## Holzkratt Pro Bandsaw HBS 351/HBS 431/HBS 433



- Smooth and precise running due to accurate machining.
- Large cast iron table which is precisely ground and polished surface.
- Laser unit for guiding the cut.
- With two speeds as standard.
- Precise 3-roller saw guide.
- Rapid adjustment of the cutting height via rotary knob.
- Smoothly running aluminium parallel stop with eccentric quick-action clamp.
- Mitre guide included.
- Interlock switches on the doors.

Specification	HLZ351PBS	HLZ431PBS	HLZ433PBS
Working table dimensions	495 x 356mm	610 x 431mm	
Cutting speeds	650/400m/min	900/450m/min	
Flywheel Ø	356mm	430mm	
Max. cutting height	200mm	270mm	
Max. cutting width with stop	321mm	370mm	
Max cutting width without stop	346mm	410mm	
Saw belt length	2562mm	3345mm	
Precision guiding 3 rolls	Top / Bottom		
Saw bench inclination	-10° - +45°*		
Motor power	550W 230V/1ph	1.5kW 230V/1ph	1.5kW 400V/3ph
Weight	80kg	130kg	
Dimensions L x W x D	610 x 445 x 1753mm	768 x 512 x 2048mm	
Suction nozzle diameter	100mm	2 x 100 mm	

CODE	Description	Unit	1+
HLZ351PBS	351/1ph	1	<b>1295.00</b>
HLZ431PBS	431/1ph	1	<b>2375.00</b>
HLZ433PBS	433/3ph	1	<b>2395.00</b>

## ACM Education Bandsaw Range 1 Phase or 3 Phase



- A special series of band saws made in Italy, designed and engineered to give technicians and students maximum security combined with the traditional solidity and quality.
- Professional Laguna ceramic upper and lower roller blade guides and a tilting table 0° to 45°.
- Self-releasing kick stop, electro-mechanical motor brake and solid cast wheels with crowned bonded rubber.
- Key locked security system on doors and isolator.
- Available in 3 sizes see website for specification.
- 3ph has a 2 speed motor.

CODE	Description	Unit	1+
BSW441EDU	440 - 1ph	1	<b>See website</b>
BSW442EDU	442 - 3ph	1	<b>See website</b>
BSW541EDU	540 - 1ph	1	<b>See website</b>
BSW542EDU	542 - 3ph	1	<b>See website</b>
BSW642EDU	642 - 3ph	1	<b>See website</b>

## Felder Bandsaw FB 510



- Electronically balanced, solid cast iron wheels.
- Upper and lower blade guides with saw blade tension indicator.
- Cast iron bandsaw table, tiltable up to 45°.
- Optional X-Life® Ceramic bandsaw blade guide system.
- Quality and precision from Austria, CE certified – see website for specification

CODE	Description	Unit	1+
FLD510BSW	FB 510	1	<b>Call for Price</b>

## Hammer Planer/Thicknesser A3 41A



- Long, heavily ribbed cast iron planer tables offer precision and stability (spindle moulder can be disconnected).
- 3 knife quick-change, self-setting cutterblock system.
- Large capacity for planing and thickening.
- Optional Silent-POWER® spiral cutterblock for sensationally quietly planing.
- Quality and precision from Austria, CE certified – see website for specification.

CODE	Description	Unit	1+
HMM341PTH	A3 41A	1	<b>Call for Price</b>

## Felder Planer/Thicknesser A941



- Advanced and innovative design to produce perfectly planed surfaces.
- The Felder planer guard for highest safety with maximum user comfort.
- Easy to read scale, optimally integrated into the machine chassis.
- Optional Silent-POWER® spiral cutterblock for sensationally quietly planing.
- Quality and precision from Austria, CE certified – see website for specification

CODE	Description	Unit	1+
FLD941PTH	A941	1	<b>Call for Price</b>

## Hammer Bandsaw Range N2-35



- A quality made bandsaw with a 235 mm cutting height and a powerful motor.
- Swivelling, heavy grey cast iron machine table with solid cast aluminium wheels.
- Precise rip fence with fine adjusted upper and lower saw blade guide for optimum performance. Optional base unit and mitre fence available.
- Quality and precision from Austria, CE certified – see website for specification.
- Optional base unit for the Hammer N2-35.

CODE	Description	Unit	1+
HMM235BSW	N2-35	1	<b>Call for Price</b>
HMM235BSU	Base Unit	1	<b>Call for Price</b>

## Push Stick



- Push sticks are vital accessories for any wood machining shop.
- Sturdy 420mm (16½") long plastic sticks which will not damage cutters.

CODE	Description	Unit	4+	1+
PHS420PLS	420mm	1	<b>3.50</b>	3.95

## Hammer Bandsaw Range N3800



- High quality bandsaw with easy to change blades and rack and pinion blade guide adjustment.
- Precision ground solid grey cast iron table with reinforced, low-vibration machine base-frame, ensuring maximum stability.
- Available in 2 different sized options.
- Optional X-Life® Ceramic bandsaw blade guide system.
- Quality and precision from Austria, CE certified – see website for specification

CODE	Description	Unit	1+
HMM380BSW	N3800	1	<b>Call for Price</b>

## Hammer Bandsaw Range N4400



- High quality bandsaw with easy to change blades.
- Precision ground solid grey cast iron table with reinforced, low-vibration machine base-frame, ensuring maximum stability.
- Available in 2 different sized options.
- Optional X-Life® Ceramic bandsaw blade guide system.
- Quality and precision from Austria, CE certified – see website for specification

CODE	Description	Unit	1+
HMM440BSW	N4400	1	<b>Call for Price</b>

## Hammer Panel Saw K3 Winner or K3 Winner Comfort



- Precision circular saw for exact rip cut and precise cross cuts using the format sliding table.
- Heavy bar for secure rip fence adjustments.
- Available as either the Winner or Winner Comfort which has the 2000mm sliding table and outrigger table with mitre index.
- Quality and precision from Austria, CE certified – see website for specification.

CODE	Description	Unit	1+
HMM300PSW	K3 Winner	1	<b>Call for Price</b>
HMM300CMF	K3 Winner Comfort	1	<b>Call for Price</b>

## Hammer Combination Machine C3 41 or C3 41 Comfort



- Precision combination machine for multiple function - circular saw, planer, thickener, spindle moulder, and optional horizontal mortiser (spindle moulder can be disconnected).
- Compact design, but professional quality.
- Available as either the standard machine or the Comfort edition which has the 2000mm sliding table and outrigger table with mitre index.
- Quality and precision from Austria, CE certified – see website for specification

CODE	Description	Unit	1+
HMM341CMB	C3 41	1	<b>Call for Price</b>
HMM341CMF	C3 41 Comfort	1	<b>Call for Price</b>

## Holzstar Table Saw TKS254E



- Large machine table made of steel, with extension table as standard.
- Height adjustment of the saw blade via hand wheel.
- Powerful motor equipped with thermal overload protection.
- Large central suction connection Ø 100mm with connection to the saw blade guard.

Specification	
Cutting width with rip fence	680mm
Max. Cutting width to the left of the saw blade	650mm
Saw blade tilt	45-90°
Max. cutting height 45°/90°	58 / 80mm
Diameter saw blade	254mm
Sliding table length	400mm
Motor	1.5kW / 1ph
Dimensions L x W x H	1430 x 1000 x 1030mm
Weight	105kg

CODE	Description	Unit	1+
HLZ254CST	TKS254E	1	<b>1395.00</b>

## Sedgwick TA315 Tilting Arbor Sawbench



- Powerful, accurate, reliable, simple and safe to operate.
- Cast iron 620mm cross-cut table is designed for cutting mitres and compound angles, end trimming, squaring, dividing and trimming.
- Rip fence is aluminium section fence, for ripping and angled ripping and for movement.
- Fence is fixed to a heavy duty cast iron mounting bracket for rigidity, with an integral micro adjustment.
- Assembly runs on a nylon roller, gliding easily across the beds, and is supported by a 30/40mm diameter solid steel bar.
- Sealed for life' bearings mounted in a cast iron housing.
- Rise and fall and tilt mechanisms are easily accessible.
- Blade changing does not require the guard to be removed.
- Thermal overload no-volt release protection.
- Lock off emergency stop and foot stop.

CODE	Description	Unit	1+
SDG315SNP	Sawbench 315 1ph	1	<b>See Website</b>
SDG315THP	Sawbench 315 3ph	1	<b>See Website</b>

## Sedgwick PT Planer Thickener



Please contact us for latest deals

- Designed and built for precision, long life and minimum maintenance.
- The rigid mainframe assembly give exceptional stability, and accurately house the feed and cutter block bearings, and the infeed and thickening tables.
- For long term accuracy, and to avoid time consuming mode changes, the surfacing tables remain in place when thickening, utilising the dual function chip collection hood.
- Cutter block is guarded at the rear by a fixed guard attached to the fence, and at the front by a bridge type guard.
- Cast iron base, side frames, and fixed outfeed table.
- Bearings are 'sealed for life' for minimum maintenance.
- The cast iron thickening table is mounted on a large diameter precision ground pillar to ensure precise and parallel positioning .
- The generously proportioned cast iron fence is then mounted off the table on a cast iron bracket and can be tilted between 90° - 45°.
- Adjustable Shaw guards for rebating are also supplied.
- Emergency stop can be fitted on request.

Specification	
Surface Capacity	255mm
Thickening Width	255mm
Thickening Depth	180mm
Rebate Depth	13mm
Surface Table Length	1200mm
Infeed Table Length	600mm
Surface Table Height	830mm
Thickening Table Length	600mm
Cutterblock Diameter	80mm
Cutterblock Knives	2
Feed Roller Diameter	40mm
Feed Speed	5.5m/min
Fence Size	550 x 90mm
Cutter Block Motor	1.5kW
Nett Weight	195kg
Dust Extraction Outlet Dia.	125mm
Dimensions L x W x H	1400 x 800 x 1160mm

CODE	Description	Unit	1+
SDG251PTN	Planer Thickener 1ph	1	<b>See Website</b>
SDG253PTN	Planer Thickener 3ph	1	<b>See Website</b>

## Holzstar Woodturning Lathe DB 450



- Made of grey cast iron for vibration-free running.
- Tailstock with revolving center point.

Specifications	
Max. turning diameter	254mm
Distance between centres	450mm
Spindle head thread	M33 x 3.5
Speeds	680, 1000, 1400, 2000, 2800 min-1
Speed steps (v-belt)	5
Motor	370W/ 230V/1ph
Tailstock taper:	2MT
Weight	35kg
Dimension L x W x H	820 x 300 x 430mm

CODE	Description	Unit	1+
HLZ450WTL	Small Woodturning	1	<b>395.00</b>

## Holzstar Woodturning Lathe DB 900



- Woodturning lathe with variable speed and digital display.
- Grey cast iron machine bed and tailstock and headstock.
- Wide, easily adjustable tool rest.
- Tailstock with quick release lever and hand wheel with revolving centre point.
- The headstock can be rotated by 180° for turning large diameter.

Specifications	
Max. Turning diameter	306mm
Distance between centres	900mm
Spindle head thread	M 33 x 3.5
Speed (variable)	500 - 2000 1min-1
Engine power motor	550W / 230V / 1ph
Machine tapers	2MT
Weight	80kg
Dimensions L x W x H	1380 x 330 x 370mm

CODE	Description	Unit	1+
HLZ900WTL	DB900	1	<b>795.00</b>

## Holzstar Woodturning Lathe DB 1100



- Woodturning lathe with variable speed and digital display.
- Grey cast iron machine bed and tailstock and headstock.
- Wide, easily adjustable tool rest.
- Tailstock with quick release lever and hand wheel with revolving centre point.
- The headstock can be rotated by 180° for turning large diameter.

Specifications	
Max. Turning diameter	358mm
Distance between centres	1100mm
Spindle head thread	M 33 x 3.5
Speed (variable)	500 - 2000 1min-2
Motor	750W/ 230V/ 1ph
Machine tapers	2MT
Weight	92kg
Dimensions L x W x H	1620 x 340 x 430mm

CODE	Description	Unit	1+
HLZ110WTL	DB110	1	<b>1125.00</b>

## Holzstar Woodturning Lathe DB 1202



- Heavy duty Woodturning lathe and stand with infinitely variable speed control.
- Robust cast iron machine bed ensures vibration-free running.
- Headstock can be moved freely along the machine bed.
- Tailstock and headstock are also made of rigid grey cast iron.
- Tailstock quick release lever and hand wheel with revolving centre.

Specifications	
Max. Turning diameter	460mm
Distance between centres	1185mm
Spindle head thread	M 33 x 3.5
Speeds (variable)	0-3,200 min-1
Engine power	1500W / 230 / 1ph
Machine tapers	2MT
Weight	185kg
Dimensions L x W x H	2060 x 500 x 1200mm

CODE	Description	Unit	1+
HLZ120WTL	DB1202	1	<b>2795.00</b>

## Standard Scroll Chuck 100mm



- 4-jaw self-centring scroll chuck set, diameter 100mm.
- Thread size M33 x 3.5.
- Clamping Range outside: 51mm - 78mm.
- Clamping range inside: 40mm - 63mm.
- Screw chuck insert.

CODE	Description	Unit	1+
CHK100STD	Standard	1	<b>82.95</b>

## Pro Scroll Chuck 100mm



- 4-jaw self-centring scroll , diameter 100mm.
- Thread size M33 x 3.5.
- Clamping range outside: 50mm - 90mm.
- Clamping range inside: 38mm - 73mm.
- Two sets of jaws and screw chuck insert.

CODE	Description	Unit	1+
CHK100PRO	Pro	1	<b>122.95</b>

## Independent 4 Jaw Chuck 150mm



- Independent 4-jaw chuck, diameter 150mm (not self-centring).
- Clamping range inside: 22mm - 59mm.
- Clamping range reverse: 42mm - 157mm.
- Mount M33 thread.
- Lining clamps up to 157mm.
- Individually tensioned jaws.

CODE	Description	Unit	1+
CHK154JAW	Independent	1	<b>42.95</b>

## Woodturning Centre

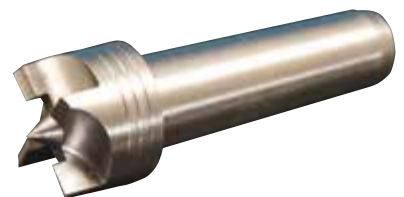

- Superior quality drive centres.
- Made from high quality carbon steel.
- 4 prong 1" diameter head.

CODE	Shank	Unit	1+
WLP1MT4DC	1MT	1	<b>21.95</b>
WLP2MT4DC	2MT	1	<b>22.50</b>

## Colchester Student 2500 / Harrison M300 Lathes



- We offer both brands as customer may wish to match their existing machines, although the Student 2500 and M300 are identical.
- Available in two bed lengths: 635mm and 1000mm between centres.
- Covered by the manufactures' parts and labour warranty.
- Induction hardened bed ways and quick change universal gearbox.

### Standard Equipment

- 3 Jaw Chuck - 160mm diameter..
- Quick Change Toolpost with 4 standard and 1 bore holder.
- Accuracy Chart.
- Covered Leadscrew.
- Machine Worklight.
- Electric Coolant Pump, Tank and Fittings.
- Full Length Foot Brake.
- Instruction and Spare Parts Manual.
- Interlocked Chuck Guard.
- Machine Toolkit.
- Splash Guard and saddle mounted chip guard.
- Thread Dial Indicator.

Specification	
Swing Over Bed	330 mm
Centre Height	167 mm
Swing Over Cross Slide	210 mm
Swing in Gap	480 mm
Spindle Nose	(Camlock) D1-4
Spindle Bore	40mm
Weight	710kg/790kg
Motor	2.2kW (3ph)

CODE	Description	Unit	1+
COL253STD	2500/635mm/3ph	1	<b>Call for Price</b>
COL253LNG	2500/1000mm/3ph	1	<b>Call for Price</b>
HAR303STD	300/635mm/3ph	1	<b>Call for Price</b>
HAR303LNG	300/1000mm/3ph	1	<b>Call for Price</b>

## OPTturn TU 1503V



- The smallest lathe with electronically adjustable speed and DC motor.
- Prism bed made of grey cast iron, hardened and ground.
- Concentricity of the spindle nose less than 0.015mm.
- Chuck guard with interlock switching.
- Three-jaw lathe chuck Ø 80mm and double tool holder.
- Fixed centre point 1MT and gear set.

Specifications	
Motor	450 W/230V / IPH
Spindle taper	1MT
Tooling size	8mm
Centre height / Turning dia.	75/150mm
Distance between centres	265mm
Spindle speeds	120-3,000rpm
Dimensions L x W x H	570 x 340 x 300mm
Net Weight	23kg

CODE	Description	Unit	1+
OPT150LTH	TU1503V	1	<b>995.00</b>

## OPTturn TU 2004V



- Modelling lathe with electronically adjustable speed and digital speed display.
- Heavily ribbed prism bed made of cast steel, induction hardened and precision ground.
- Hardened and ground Z-axis guideway.
- Three- jaw chuck Ø 100mm.
- Guaranteed concentricity of the spindle nose, less than 0.009mm.
- Automatic longitudinal / lead screw drive. Switchable right /left rotation.
- Chuck guard with interlock switching.
- 4 position tool holder and gear set.

Specifications	
Motor	600W/230V/1Ph
Spindle taper	3MT
Tooling size	12mm
Centre height / Turning dia.	300mm
Spindle speeds	150-2500rpm
Dimensions L x W x H	830 x 425 x 360mm
Net Weight	61kg

CODE	Description	Unit	1+
OPT200LTH	TU2004V	1	<b>1495.00</b>

## Optimum Lathe TU2406V

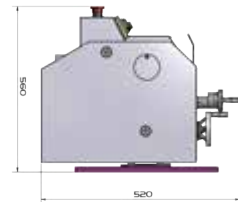
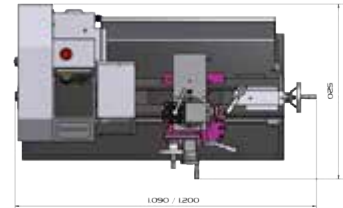

- Hardened and ground bed guideways.
- Guaranteed true running accuracy of the spindle nose less than 0.009mm.
- True running accuracy - Lathe chuck less than 0.05mm.
- Powered spindle for threading or automatic longitudinal turning.
- Emergency-stop push button.
- Forward and reverse switching.
- Powerful motor with constant torque at variable speeds.
- Interlocked chuck guard.
- Toolpost shield.
- Leadscrew covered with telescopic guard.
- Additional kickstop.

### Standard equipment

- Three-jaw chuck Ø 125mm.
- Tailstock centre 2MT.
- Spindle centre 3MT.
- Splash guard.
- Chip tray.
- 4 Station tool holder.
- Gear kit.

Specification	TU2406V
Power	230 V / 1 Ph
Spindle speed	150 - 2'500 min <sup>-1</sup>
Motor	1.1kW/230V/1Ph
Spindle taper	3 MT
Spindle hole	Ø 21mm
Tool holder cap	14 x 14mm
Centre height/ Turning dia.	125mm / 250mm
Distance between centres	550mm
Tailstock taper	2MT
Length x width x height	1,310 x 520 x 560mm
Net weight	125kg

CODE	Description	Unit	1+
OPT241VLH	TU2406 1ph	1	<b>2295.00</b>
OPT241BAS	Machine Base	1	<b>625.00</b>

## Baileigh Lathe PL-1236E-DRO



Specification	BAL126LTD
Distance between centres	914mm
Swing Over Bed	305mm
Spindle Speed	10(70-1400 rpm)
Spindle Bore	38mm
Max. Tool Selection	16mm x 16mm
Power	220 volt single phase
Weight	560kg
Dimensions	1701 x 787 x 1524

- All ways are ground and hardened to ensure long life.
- Industrial grade digital readout system for improved accuracy and efficiency.
- Features include, digital read out, three and four jaw chucks, steady rest, follow rest, face plate, live centre, foot break, coolant system and halogen work light.

CODE	Description	Unit	1+
BAL126LTD	PL-1236E DRO	1	<b>6250.00</b>

## Baileigh Precision Lathe PL-1340



Specification	BAL134PCN
Distance between centres	1016mm
Swing Over Bed	330mm
Spindle Speed	8(70-2000rpm)
Spindle Bore	38mm
Max. Tool Selection	16mm x 16mm
Power	2hp/220V/1ph
Weight	740g
Dimensions	2006 x 838 x 1500mm

- High precision lathe.
- Mitutoyo 2-axis DRO-standard.
- 175mm spindle speed.
- 203mm three jaw chuck.
- Integrated coolant system.
- Chuck guard.
- Lead screw cover.
- Headstock chuck guard with micro switch cutout.
- 4-way quick change tool post with guard.
- Capacity 330mm swing over bed, 1016mm between centers.
- Metric thread cutting (Imperial available).

Please contact us for latest deals

CODE	Description	Unit	1+
BAL134PCN	PL-1340	1	<b>14200.00</b>

## OPTImill MH 20V



- Milling machine with electronically infinitely variable drive.
  - Feed spindles adjustable without backlash.
  - Precision ground dovetail guide with adjustment.
  - Double-row angular bearings in the spindles, adjustable without backlash.
  - Safety electronics in 24 Volt version.
  - Forward/reverse operation.
  - Drilling and milling head can be tilted by  $\pm 90$ , for milling and drilling work in any position.
  - Machine lamp.
  - Height-adjustable guard with interlock switching.
  - Easy to read speed display and depth display, switchable mm/inch.
  - Emergency stop impact switch.
  - High concentricity  $\leq 0.0015$ mm measured in the quill.
- Standard equipment**
- Three jaw self-centring chucks  $\varnothing 160$ mm camlock mount.
  - Reducing bush MT5/ MT3.
  - Fixed centres 3MT and 5MT.
  - Steady rest.

Specification	OPT020MLM
Power dive motor	850W/230V/1ph
End mill size max	20mm
Spindle taper	2 MT
Spindle speed (variable)	100 - 3'000 min-1
T-slot size	12mm
X-axis manual	280mm
Y-axis manual	175mm
Z-axis manual	210mm
Length x width x height	750 x 650 x 820mm
Net weight	71kg

CODE	Description	Unit	1+
OPT020MLM	MH 20V	1	<b>1950.00</b>

## Baileigh Lathe PL-1340E



Specification	BAL134LTD
Distance Between centres	1016mm
Swing Over Bed	330mm
Spindle Speed	8 (70-2000 rpm)
Spindle Bore	38mm
Max. Tool Selection	16mm x 16mm
Power	220 volt single phase
Weight	650kg
Dimensions	2007 x 838 x 1500mm

- Industrial gear head metal lathes with precision ground and hardened ways.
- Many features digital read out, three and four jaw chucks, steady rest, follow rest. Face plate, live centre, foot break, coolant system, halogen work light, quick change tool post.

CODE	Description	Unit	1+
BAL134LTD	PL-1340E	1	<b>8900.00</b>

## Baileigh Precision Lathe PL-1640



Specification	BAL164PCN
Distance between centres	1016mm
Swing Over Bed	407mm
Spindle Speed	12(30-2000rpm)
Spindle Bore	52mm
Max. Tool Selection	16mm x 16mm
Power	7.5hp/400V/3ph
Weight	2000kg
Dimensions	2311 x 1118 x 1651mm

- High precision lathe.
- Mitutoyo 2-axis DRO-standard.
- 12-step spindle speed.
- 203mm three jaw chuck.
- Integrated coolant system.
- Chuck guard.
- Lead screw cover.
- Headstock chuck guard with micro switch cutout.
- 4-way quick change tool post with guard.
- Capacity 407mm swing over bed, 1016mm between centres.
- 400V 3-phase 50hz.

CODE	Description	Unit	1+
BAL164PCN	PL-164	1	<b>24000.00</b>

## Optimum Milling Machines MH 25SV



- Infinitely variable speed control.
- Feed spindles adjustable by re-adjustable spindle nuts.
- All guideways are ground.
- Variable feed in all axis.
- Rapid feed X-/Y-axis for rapid positioning.
- Digital speed display DRO 5.

Power	
Total connected load	2kW
Milling spindle	
Driving motor	1.5kW
Drilling capacity in steel (S235JR)	Ø 25mm
Milling head dimension max.	Ø 50mm
End mill dimension max.	Ø 25mm
Spindle seat	BT30
Throat	185mm
Drawbar thread	M12
Swivel range	45°
Spindle speeds	200 - 4,000min <sup>-1</sup>
Distance spindle - table	305mm
Table length x width	620 x 180mm
X axis travel	autom. 400mm*
Y axis travel	autom. 210mm*
Z axis travel	autom. 270mm*
X axis min./max.	150 / 930mm/min.
Y axis min./max.	100 / 580mm/min.
Z axis min./max.	80 / 450mm/min.
Length x width x height	914 x 844 x 1,119mm
Weight	200kg

CODE	Description	Unit	1+
OPT025MLM	MH25SV	1	<b>5695.00</b>

## Milling Machine Base



- Base for the Optimum Milling Machine MH 25SV.

CODE	Description	Unit	1+
OPT025BAS	Machine Base	1	<b>580.00</b>

## Optimum Milling Machine MT50



- Heavy, solid type made of high-grade grey cast iron.
- X-axis adjustable either by manual handwheel or by automatic feed equipment.
- Used as either vertical or horizontal mill.

### Standard equipment

- Coolant equipment.
- Interlocked safety guarding.
- Integrated control panel with easy-to-operate position display.
- Optimum gear rim drill chuck Ø 1 - 16mm / B18.
- Arbor for drilling chuck ISO40/B18.
- Adapter ISO40/3MT.
- Adapter ISO40/2MT.
- Milling cutter collets Ø 4 - V16mm.
- Machine lamp.

Model	MT50
Item No	3336005
Connection	400V / 3Ph ~50Hz
Overall connected load	4.5kW
Power of the coolant pump	40W
Drilling capacity in steel (S235JR)	Ø 30mm
Continuous drilling capacity in steel (S235JR)	Ø 25mm
Driving motor	1.1 / 2.2kW
Spindle seat	ISO 40 DIN 2080
Spindle stroke	120mm
Throat depth	240 - 650mm
Spindle speeds	115 - 1'750min <sup>-1</sup>
Gear speeds	8 gear stage
Driving motor	1.5 W
Spindle seat	ISO 40 DIN 2080
Throat	0 - 185mm
Spindle speeds	60 - 1'350min <sup>-1</sup>
Gear speeds	9 gear stage
Table length x width	1'000 x 240mm
Load of cross table max.	160kg
T-slot size / number	14mm / 4
X axis automatic	380mm
Table feed X-axis (8 steps)	24 - 720mm/min
Y axis manual	200mm
Z axis manual	340mm
Length x width x height	2,270 x 1,500 x 2,100mm
Total weight	900 kg

CODE	Description	Unit	1+
OPT050MLM	MT50	1	<b>11995.00</b>

## Baileigh Vertical Mill VM-942



- 3-axis DRO as standard.
- ISO 40 spindle taper.
- Power feed on X, Y and Z axis.
- Turcite B coated ways and guides for extreme durability.
- Meehanite casting for superior rigidity.
- Standard draw bar.
- Way covers and chip tray included.
- Adjustable work height.
- Supplied with interlocked guarding for educational use.

Please contact us for latest deals

CODE	Description	Unit	1+
BAL942VML	Vertical Mill VM-942	1	<b>16995.00</b>

## Clausing Vertical Mill 2VS



- Hardened and ground X, Y & Z ways.
- Hardened and ground table surface with T-slots.
- Double nut leadscrew for backlash compensation.
- Coolant system w/pump and switch.
- 7/16" imperial drawbar (2VS, 3VS).
- AC rapid vertical drive (4VSQ).
- Variable speed drive.
- Articulating head for compound angles.
- Worm gear angular positioning of head in two directions.
- Lever-operated manual rapid quill movement.
- Adjustable automatic feed disengagement for quill feed.
- Micrometre depth stop.
- Reversing switch for clockwise or counter clockwise operation.
- Halogen work light.

See website for specification

CODE	Description	Unit	1+
CLG200VML	2V3/3ph	1	<b>Call for Price</b>



## Baileigh Metal Cutting Bandsaw BSV-12 / BSV 16



- Baileigh Metal Cutting Bandsaw BSV-12.
- Table pivots left and right, forward and back for chamfer cuts.
- Tungsten carbide blade guides.
- 4-speed gear-driven transmission.
- 220V 1phase 50hz.

Please contact us for latest deals

Specification	BSV-12
Throat Depth	289mm
Maximum Thickness	196mm
Motor	1/2hp
Blade Length	2550mm
Blade Width	6mm-13mm
Blade Thickness	0.8mm
Slant of Table	10°F/Rear, 15° L/R
Table Size	501 x 501mm
Variable Blade Speed (4)	80, 133, 191, 319rpm
Butt-Welder Capacity (Blade width)	13mm
Service Requirements	220V 1-phase 50hz
Shipping Dimensions (LxWxH)	914 x 686 x 1549mm
Shipping Weight	200kgs

CODE	Description	Unit	1+
BAL120MCB	BSV-12	1	<b>4100.00</b>

### SEE CUTTING TOOLS

### Bandsaw Blades



## Metallkraft Bench Dry Saw No.356



- Features a brushless 3.5kW/230V motor, for low-burr sawing of profiles and tubes made of steel, iron, copper, brass, aluminium, plastics and composites, without coolant.
- Four speeds selectable at the push of a button, with a soft start motor.
- Digital display with indication of selected speed and current power in Watt.
- Supplied with a 355mm TCT metal cutting blade.
- Cutting capacity 0° (round) pipe - 130mm, Cutting capacity 0° (square) pipe - 125 x 125mm and Cutting capacity 0° (rectangle) pipe - 170 x 110mm.

#### Specification

Motor power:	230 V / 50 Hz 3.5 kW
Saw blade diameter	Ø: 355 mm.
Weight	25 kg.

CODE	Description	Unit	1+
MKT356BDS	Dry Saw	1	<b>595.00</b>
MTK357TCT	Spare TCT Blade	1	<b>145.00</b>

## Metallkraft Bench Cold Saw 250



- Double vice, angles from -45° to +45° with quick action clamping.
- Scope of delivery:
- Coolant equipment.
- Length stop 500mm.
- Include H.S.S blade and machine base.
- Cutting capacity 70 x 95mm

#### Specification

Motor power:	50Hz
Speeds:	40min-1
Saw blade diameter	Ø 250mm
Footprint in mm	800 x 830 x 755mm
Weight	83kg

CODE	Description	Unit	1+
MTK251CSW	250mm	1	<b>1575.00</b>

## Optimum Bandsaw SP13



Push button "Manual saw band running".

- Bench mounted bandsaw with high cutting precision, particularly low-noise and infinity variable saw belt speed.
- Sawing arc adjustable from 0° to +60°.
- High grade bi-metal blade supplied.
- Adjustable material stop.

#### Specification

Cutting capacity	125 x 125mm
Speed (variable)	30 - 80m/min
Length	1440mm
Net weight	19.5kg

CODE	Description	Unit	1+
OPT013BSW	SP13V	1	<b>650.00</b>

## Optimum Bandsaw SP131GH



- Quick-action vice for rapid workpiece clamping.
- Supplied with bi-metal HSS blade.
- Includes machine base and material stop.

#### Specification

Cutting capacity	100 x 150mm
Motor power	1.1kW / 230V / 1Ph
Saw band speed	22 / 31 / 55m/min
Blade length	1638mm
Weight	81kg

CODE	Description	Unit	1+
OPT131BSW	SP131GH	1	<b>1275.00</b>

## Roller Table 2m



- Robustly constructed roller table that can be used for infeed or outfeed.
- Ideally suited for metal band saws, cold saws, mitre and radial arm saws.

### Dimensions

Length x width	2'000 x 440mm
Height H version	660 - 1050mm
Net weight	58 / 61kg
Diameter of support rollers	60mm
Static table load	700kg

CODE	Description	Unit	1+
OPT207RLT	Roller Table 2m	1	<b>480.00</b>



Please contact us for your Baileigh requirements  
[www.tilgear.co.uk](http://www.tilgear.co.uk)

SEE STORAGE PAGE 299

## Multi-Height Sheet Rack



## Vertical Bar Rack

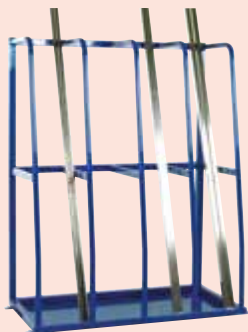

## Sheet Metal Shears Floor Standing



- Solid and robust welding construction.
- Suitable to cut metals, paper and other materials.
- Rubberised material holding down clamp to prevent the work piece from slipping away.
- The holding down clamp is at the same time a finger guard, maximum distance from the holding down clamp to the working table.
- Adjustable angular stop with millimetre scale.
- Back gauge is 500 mm.
- Type Item No: FTBS 1050-10 377 2910.
- Working width: 1050mm.
- Sheet thickness\*: 1,00mm.
- Back gauge: 500mm.
- Motor power 400V/50Hz.
- Weight: 275kg.

### Specification

Type / Item No	FTBS 1050-10 / 377 2910
Working width	1050mm
Sheet thickness*	1.00mm
Back gauge	500mm
Motor power	400V/50Hz
Weight	275kg

CODE	Description	Unit	1+
MTK105FTS	1050mm Foot Operated	1	<b>2475.00</b>

## Mataikraft TBS Sheet Metal Shears.



- To cut metal, paper, plastic material and other materials.
- With mitre stop at the front.
- Hardened high carbon steel cutter.
- Rear limit stop with scale.

Specification	MTK650TBS	MTK105TBS
Type / Item No	TBS 650-12 T / 377 6165	TBS 1050-10 T / 377 6111
Working width max.	650mm	1050mm
Sheet thickness*	1.25mm	1.00mm
Rear limit stop range	0-500mm	
Weight	100kg	160kg
Dimensions	970 x 470 x 540mm	1370 x 480 x 580mm

CODE	Description	Unit	1+
MTK650TBS	650mm TBS	1	<b>950.00</b>
MTK105TBS	1050mm TBS	1	<b>1360.00</b>

## Metalkraft Metal Shear Electric 1050mm



- Adjustable angular stop.
- Guard.
- Foot pedal.

### Specification

Type / Item No	MTBS 1050-10 / 377 2915
Working width	1050mm
Sheet thickness*	1.00mm
Back gauge	500mm
Motor power	400V/50Hz / 0.75kW
Weight	238kg

CODE	Description	Unit	1+
MTK105MTS	1050mm Electric	1	<b>2995.00</b>

## Magnetic Box & Pan Brake BB-4816M



- 1219mm x 16-gauge mild steel capacity.
- Magnetic clamping brake.
- Unlimited box depth.
- Bending stop included.
- 220V 1-phase 50hz.

Please contact us for latest deals

Specification	
Length	1219mm
Thickness (SS)	1.6mm (1mm)
Bend Angle	0-180°
Clamping Force	6 Ton
Max. Clamping Bar Lift (magnet)	unlimited
Box Depth	unlimited
Power Requirements	220V 1-phase 50hz
Shipping Dimensions (LxWxH)	1448 x 1118 x 864mm
Shipping Weight	210kgs

CODE	Description	Unit	1+
BAL481BPB	BB-4816M	1	<b>2250.00</b>

## XL5+ Power Bender



- The XL5+ Power Bender packs in 5+ functions - Bends in a single pull of a lever upto 60° angles in 12mm thick material and upto 90° angles in material beyond 12mm and upto 16mm thick. Unique design allows a wide range of steel profiles to be bent progressively in order to curve steel into complex shapes.
- Shears effortlessly up to 25mm x 8mm / 40mm x 6mm Flat, 10mm square and 12mm round.
- Rolls arches, curves and rings in flat and square bars max 50mm x 6mm / 40mm x 8mm flat and 16mm square.
- Punches up to 6mm diameter in 6mm steel, rivets up 6mm diameter and includes a measuring bar device for accurate and repeatable punching and shearing.
- L 110mm x W 430mm x H 360mm with a 720mm handle.

CODE	Description	Unit	1+
MCR732PBR	XLS5+	1	<b>1080.00</b>

## Master Punch / Shear Tool



- A robust, dual purpose steel guillotine and hole punching tool for the easy cutting 25mm x 5mm (flat strip), 6mm (square bar), 6mm (round bar/wire) and punching of mild steel strip and bar up to a maximum of 6mm thickness.
- The metal punch tool easily punches holes in steel by using a punch block and pin which is specially machined and hardened for the task.
- Accurate positioning along the centre of different widths of bar, the adjustable platform is used to ensure consistent results.
- Complete with three punch and dies - 3mm (up to 3mm thickness), 5mm (up to 5mm thickness) and 6mm (up to 3mm thickness).
- L 60mm x W 285mm x H 155mm with a 450mm handle.

CODE	Description	Unit	1+
MCR015MPS	Practical P/S	1	<b>295.00</b>

## Riveting, Bending & Rolling Tool



- One of the most versatile hand metal working tools, without the need of power or heat.
- Special rivet posts fitted to provide a secure, strong and authentic looking joint - 3mm rivet diameter.
- Metal bender for angles up to 90 degrees - 20mm x 3mm (flat strip), 5mm (round), 4mm (square bar).
- Special winding handle attachment to roll curves and circles 20mm x 3mm (flat strip), 5mm (round), 4mm (square bar), which turns it into the perfect metal shaping tool for school metalwork classes.
- L 165mm x W 150mm x H 60mm with a 300mm handle.

CODE	Description	Unit	1+
MCR014RBR	Practical RBR	1	<b>174.50</b>

## Master Riveting, Bending & Rolling Tool



- The Master Riveting, Bending & Rolling is the ultimate wrought iron bender and metal shaping tool and is supplied with the new Micro Bender.
- Riveting (up to 5mm dia.), standard bender - 25mm x 5mm (flat strip) 10mm (round), 10mm (square bar), micro bender - 20mm x 3mm (flat strip) 6mm (round), 6mm (square) and rolling - 25mm x 6mm or 30mm x 5mm (flat strip), 10mm (round), 10mm (square bar).
- Micro bender enables tight bends, radiused bends and free form progressive bending.
- L 165mm x W 290mm x H 115mm with a 440mm handle.

CODE	Description	Unit	1+
MCR016MRB	Master RBR	1	<b>415.00</b>

## Mk 1/2 Scroll Former



- The Mk 1/2 Scroll Former is the smallest in the range of scroll bending tools.
- Produces consistent small ornamental scrolls up to 76mm across, using smaller material up to 13mm x 2mm.
- Draws the steel around inner its central segment to create the initial part of the scroll and you then drop in the outer segment to make the scroll bigger if required.
- By using a marker to use the point at which you stop, you can make repeated identical scrolls.
- L 100mm x W 100mm x H 45mm

CODE	Description	Unit	1+
MCR017SRF	Mk 1/2	1	<b>37.50</b>

## Mk 2/3 Scroll Former plus Tube Bending



- A combined larger scroll maker with a couple of special tube bending components.
- Special pressure guide roller, with a maximum scroll material capacity of 20mm x 3mm and maximum size of 127mm.
- The larger tube former is cleverly designed to fit underneath and be driven by the scrollers handle capstan and centre segment.
- Maximum tube material dimensions of 10mm outer diameter with a wall thickness 1.2mm and the inner tube former bend of 49.7mm diameter.
- L 150mm x W 230mm x H 120mm x 210mm working handle radius

CODE	Description	Unit	1+
MCR029SFB	Mk 2/3	1	<b>165.00</b>

## Practical Punch / Shear Tool



- A two-in-one guillotine for steel strip cutting - 20mm x 3mm (flat strip), 5mm (square bar), 5mm (round bar/wire) and a metal punch tool – up to 3mm diameter holes in steel strip up to 3mm thickness.
- Simply push the handle away from you to produce a neat cut in complete safety.
- Supplied with a special measuring bar to enable accurate cut lengths and consistently spaced punched holes.
- L 50mm (930mm with measuring bar fitted) x W 175mm x H 130mm with a 340mm handle.

CODE	Description	Unit	1+
MCR013PST	Practical P/S	1	<b>182.50</b>

## Metalcrafter Bench



- The Metalcrafter bench can accommodate all the tools of a Practical Pro Workshop or Master Workshop plus optional Master Twister.
- Strong, easy to assemble bolt-less workbench.
- Both shelves are made from Qmark Exterior Plywood.
- L 1235mm x W 775mm x H 925mm.

CODE	Description	Unit	1+
MCR123BNC	Bench	1	<b>174.95</b>

## Practical Workshop



- The Practical Workshop is a good entry point for work with material sizes from 10mm x 1.6mm up to 20mm x 3mm.
- Contains: Riveting, Bending & Rolling Tool, Practical Punch/Shear Tool (with Spare Punch Pin), Mk 1/2 Scroll Former and Mk 2/2 (H) Scroll Former.
- Supplied with Metalcraft User Guide and Design & Ideas Booklets, and scroll profile drawings and magnetic markers.
- Includes tape measuring device.

CODE	Description	Unit	1+
MCR003PWS	Practical	1	<b>407.50</b>

## Practical Pro Workshop



- Top of the Practical range of workshops and represents terrific value, works with material sizes from 10mm x 1.6mm up to 20mm x 3mm.
- Contains: Riveting, bending & rolling tool, practical punch/shear tool (with spare punch pin), Mk 1/2 scroll former, Mk 2/3 Scroll Former with Tube Bending components and practical twisting tool comes with adapter.
- Supplied with Metalcraft User Guide and Design & Ideas Booklets, and scroll profile drawings and magnetic markers.
- Includes tape measuring device.

CODE	Description	Unit	1+
MCR005PRW	Pro	1	<b>582.50</b>

## Flat Bar Bright Annealed Mild Steel

Packs of 30, 35 or 50



- Bright Annealed material which has specially softened during manufacture to make it perfect for bending and shaping.
- Clean, bright and shiny finish - easy to work.
- Suitable for use with all Metalcraft tools.
- 914mm length.

CODE	Description	Unit	1+
MCR101BAS	10 x 1.6mm	Pack 30	<b>29.95</b>
MCR122BAS	12 x 2mm	Pack 50	<b>45.95</b>
MCR153BAS	15 x 3mm	Pack 35	<b>55.95</b>

## Traditional Rivets

Pack of 120



- Traditional steel rivets with a 3mm diameter shank
- Guide for rivet length: 2-3mm protruding if up to 3mm combined thickness and 3-5mm if greater than 3mm.
- Available in four different lengths.

CODE	Description	Unit	1+
MCR306RVT	3 x 6mm	Pack of 120	<b>4.95</b>
MCR308RVT	3 x 8mm	Pack of 120	<b>4.95</b>
MCR310RVT	3 x 10mm	Pack of 120	<b>4.95</b>
MCR312RVT	3 x 12mm	Pack of 120	<b>4.95</b>

## Master Workshop



- The Master Workshop works with steel sizes up to 25mm x 5mm, for the more advanced educational/training establishments.
- Contains: Master RBR tool with micro bender, master punch/shear tool (comes with interchangeable 3mm, 5mm and 6mm punch pins and blocks).
- Mk 2/3 and Mk 3/3 Scroll Formers complete with tube forming components.
- Supplied with Metalcraft User Guide and Design & Ideas Booklets, and scroll profile drawings and magnetic markers."
- Includes tape measuring device

CODE	Description	Unit	1+
MCR004MWS	Master	1	<b>1195.00</b>

## XL Workshop



- The flagship kit aimed at engineering training establishments looking for powerful and versatile metalworking tools.
- Contains: XL5+ Power Bender complete with all of its 5 options packs, XL twisting tool complete with basket maker and Mk 3/4 scroll former complete with tube bending components.
- Includes User Guide and Design & Ideas Booklets.

CODE	Description	Unit	1+
MCR007XLW	XL	1	<b>2395.00</b>

## Tea Light Holder

Pack of 120



- Height 20mm, diameter outer- (max) 50.5mm, inner- 39.5mm, thickness 1mm.

CODE	Description	Unit	10+	1+
MCR120TLU	Unpunched	1	<b>0.75</b>	0.80
MCR121TLP	Punched	1	<b>0.80</b>	0.85

## Chunky Candle Tray

76mm or 125mm



- Pre-punched with a central 3mm diameter hole to allow fixing to metalwork.
- Diameter 76mm or 125mm

CODE	Description	Unit	10+	1+
MCR076CDT	76mm	1	<b>1.10</b>	1.25
MCR125CDT	125mm	1	<b>1.50</b>	1.75

## Gabro Box Pan Brakes



Please contact us for latest deals

- As a box pan folder, a unique feature of the BF series for forming box ends is the use of standard steel angle cut as required for work clamping rather than conventional segments. A narrow bed assures that return bends are made with the work piece suspended inside the folder. Even boxes or pans with sloping sides are easily fabricated.
- Folds sheets of 18ga. Mild steel as wide as the folder. Patented Gabro featured is the selective bending ability, completing partial or interrupted folds easily and quickly.
- Can fabricate louvers, scrolls and cylindrical shapes.
- Minimum Box Size: 12 x 12 x 6mm deep
- Maximum Box Size: 250 x 250 x 180mm deep or 600 x 575 x 12mm deep

Material Thickness		Maximum length of bend (2g radius)
Mild Steel	Soft Aluminium	
1.2mm	1.5mm	620mm
1.6mm	2.0mm	475mm
2.0mm	2.6mm	300mm
2.6mm	3.2mm	200mm
3.2mm	4.0mm	100mm
5.0mm	6.0mm	25mm

Specification	Stand Mount	Bench Mount
Width	750mm	750mm
Depth	579mm	579mm
Height	1283mm	546mm
Weight	109kg	95kg

CODE	Description	Unit	1+
GAB620BPB	Box Pan Brakes	1	<a href="#">See Website</a>
GAB621BPB	Stand	1	<a href="#">See Website</a>

## Gabro Sheet Folder



Please contact us for latest deals

- The SF600 can fold nearly two feet of 22ga. Mild steel or one foot of 18 ga.
- It is extremely economical for general metalforming applications.

Specification	Model SF600	
Folding Capacity	(Max Thickness for Given Widths)	
Width of Bend	300mm	600mm
Max. Thickness	Mild Steel 1.25mm	Mild Steel 0.8mm
	Aluminium 2.0mm	Mild Steel 1.25mm
Dimensions	752mm W x 300mm D x 130mm H	
Weight	11kg	

CODE	Description	Unit	1+
GAB600SHF	Sheet Folder	1	<a href="#">See Website</a>
GAB601SHF	Stand	1	<a href="#">See Website</a>

## Gabro Shear Notcher



Please contact us for latest deals

- Conventional shears have a scissors action that results in distortion of one or both of the cut pieces. Gabro has a better way. By using a blade and a die, a thin strip of material is blanked out. Both sections are left entirely undistorted and free from sharp edges. The clearance between the blade and the die is readily adjustable for the thickness of the material.
- Progressive cutting action allows sheet of unlimited length to be cut.
- Stainless steel, cut mild steel and non-ferrous metals, perforated and expanded metals, hardboard, laminates and plastics.
- Side fence can be clamped anywhere along the front of the table with fine adjustment.
- Convenient angle guide and backstop are provided.

Specification	2M2	3M2
Max - Mild Steel	1.6mm	3.2mm
Max - Stainless Steel	1.4mm	1.8mm
Max - Non-Ferrous Metals	3.2mm	4.0mm
Without die adjustment	0.25mm	0.3mm
Blade/die clearance each side	0.05mm	0.08mm
Standard blade thickness	3.3mm	4.5mm
Max. length of cut - one stroke	70mm	108mm
Table size - width x depth	480 x 370mm	859 x 560mm
Floor space with stand W x D	460 x 810mm	890 x 970mm
Table height with stand	810mm	810mm
Height with stand (handle up)	1619mm	1950mm
Height with stand (handle down)	1012mm	1040mm
Weight without stand	12.0kg	46.0kg
Weight with stand	21.0kg	67.0kg

CODE	Model	Unit	1+
GAB202SHN	2M2	1	<a href="#">See Website</a>
GAB302SHN	3M2	1	<a href="#">See Website</a>
GAB312SHN	3M2 Wheeled Stand	1	<a href="#">See Website</a>

## Professional Vacuum Bagpress System



- The Bagpress System is ideal for single and dual bag veneering and laminating operations. It can also be used for vacuum clamping and vacuum template routing.
- 8m3 per hour dry running rotary vane pump developing 85% vacuum giving a pressure of 8.5 tonnes per square metre at sea level.
- Lacquered plywood frame with integral handle.
- Built-in vacuum gauge.
- 300mm x 210mm x 245mm (w x d x h).
- Weight 13kg.

### Kit Includes

- Pump assembly with single 8mm vacuum port.
- 1300mm x 2500mm 300 micron seamless polyurethane bag.
- Two 1350mm sealing strips.
- Heavy duty footswitch.
- Breather fabric.
- 8mm polyurethane air hose.
- Bag connector and 8mm pushfit connector.

Please contact us for latest deals

### Warranty

- Three years parts and labour against mechanical and material failure.

CODE	Description	Unit	1+
BGP800SET	Pro Vacuum Press System	1	<b>899.00</b>

## Bagpress MiniPress Kit MkII



- This simple but effective vacuum press uses a sealable bag into which materials are placed, sealed and then a vacuum applied. The uniformity of pressure available with this vacuum press can't be applied by mechanical clamping.
- As atmospheric pressure is about 10 tonnes per square metre, this means that a pressure of 8.5 tonnes per square metre is being exerted on everything inside the bag.
- Kit comes complete with an 800mm x 1300mm, 200 micron, polyurethane bag; 2 sets of closure strips; bag connector and push-fit adaptor.
- The pump itself is supplied in a plywood storage box with breather fabric so, basically, everything you need to start vacuum pressing.

CODE	Description	Unit	1+
BGP200SET	Extruder	1	<b>399.00</b>

Flamefast

## Forge & Hearth DS 4305



Please contact us for latest deals

- Complies with British Gas Standards and is a fully fail safe system.
- The system has a whisper quiet air fan, push-button no-volt release starter and non-return gas valves.

### Forging - Standard Equipment

- Ceramic hearth.
- Full manual control of hearth conditions.
- 12.5Kg of ceramic chippings.
- Side and rear heat shields.
- Rake iron.

### Brazing - Standard Equipment

- 1 asbestos-free heat resistant refractory hearth.
- 2 full size Heat Reflective Blocks.
- 4 half size Heat Reflective Blocks.
- 1 RF 80 brazing torch (twin torch versions available)
- Colour coded reinforced gas and air hoses.
- Push button electronic ignition.

CODE	Description	Unit	1+
FLF430BHF	Chip Forge & Hearth	1	Call for Price

## Flamefast Double Brazing Hearth DS400D



Please contact us for latest deals

- Dual station brazing hearth, which can be fitted with Varivac Hoods.
- Supplied with 2 easy-to-use single valve controlled RF80 torches which allow one hand operation.
- Solid refractory hearth with robust side, central and rear heat shields.
- Complies with British Gas standards and is a fully failsafe system.
- Size (cm) 149 x 74 x 120H.
- Net Weight: 215kg

CODE	Description	Unit	1+
FLF400DBH	DS400D	1	Call for Price
FLF401DBH	LPG	1	Call for Price

## Flamefast Casting System



- Safe method for demonstrating casting and moulding techniques, in a standard classroom, requiring only a standard. 13amp-240V socket.
- Doesn't require any extraction system.
- Unique cooling system keeps the entire case cold to touch.
- Quick set up and ready to use time in just 15 minutes.
- Moulds can be manufactured in vulcanised rubber, cardboard, MDF, wood, and many other materials.
- Maximum mould size is 100 x 30mm; larger sizes can be achieved without using the mould holding device.
- Pre-made moulds can be purchased separately along with Pewter.
- 2.3kg Crucible capacity for Lead
- Free Pewter.
- Thermostatically controlled at either 250° or 150° C.

### Dimensions

- 300mm(H) x 242mm(W) x 280mm(D).
- Weight 10kg.

### Standard supply

- Low Temperature casting unit.
- Mould holder and clip.
- 5 sticks of Lead Free Pewter - approx.1kg.
- 1 MDF mould.
- Spill tray.

Please contact us for latest deals

CODE	Description	Unit	1+
FLF100CSS	Flamefast System	1	885.00

## CM450 Safety Tilt Crucible Furnace



- Easy to use furnace is ideal for fast melts of aluminium.
- Incorporates the 'tilt and pour' principle, leading to safer metal pouring.

### Standard Equipment

- Piezo ignition and flame failure device.
- A10 capacity crucible pot.
- Super-efficient insulation.
- Crucible lid.
- Tilt handle.
- Pouring gauge.
- Degassing plunger.
- Skimming ladle/dross lifter.
- Cut-out prevents burner from operating when the drum is tilted.
- Dimensions: 330mm(H) x 450mm(W) x 330mm(D).

Please contact us for latest deals

CODE	Description	Unit	1+
FLF450CCB	Crucible Furnace	1	Call for Price
FLF128TRY	Sand Tray	1	Call for Price

## Varivac Extractor Hood



- The Varivac is a modular extraction system that can be used in a range of configurations and combinations of either flexible arm or extraction hood units. The unique fume intake configuration of the Varivac captures all fumes and prevents any spillage.
- Electrical interlock prevents the use of any linked equipment before the Varivac is switched ON.
- Can be fitted to existing equipment if required with a choice of low level or high rise exhaust outlets.
- Efficient at-source hood.
- Quiet operation.
- Robust construction.
- Low running costs maintenance Free.
- Improves the environment and complies with COSHH Regulations.

Please contact us for latest deals

CODE	Description	Unit	1+
FLF503EXH	Extractor Hood	1	Call for Price
FLF513EXH	Extractor Hood Double	1	Call for Price

SEE MATERIALS PAGE 23

## Lead Free Pewter





# Art

---

**Sketchbooks**  
248-251

---

**Paper & Card**  
248-253

---

**Paint**  
254-258

---

**Brushes**  
259-260

---

**Art Sundries**  
260-261

---

**Pottery**  
262-263

---

**Enamelling**  
263

---

**Airbrush Equipment**  
263

---

**Lino Printing**  
264-265

---

**Modelling**  
265-269

---

**Drying Racks**  
269

**TILGEAR**

2023/24 ISSUE 58



LET'S CREATE

Carlsson Sketch Books are manufactured in the UK using high quality cartridge paper. Highly versatile ideal for use with a wide range of media.

## Carlsson Black Matt Sketch Book A4

- Carlsson Sketch are manufactured in the UK using a high quality cartridge paper.
- Matt black card cover.
- 100gsm 40 page.



CODE	Description	Unit	20+	10+	1+
CLS104SBK	A4 Portrait	1	1.15	1.20	1.30

## Carlsson Black Laminated Sketch Book A4 and A3

- Carlsson Sketch are manufactured in the UK using a high quality cartridge paper.
- Laminated black cover - easy to wipe clean.
- 140gsm 40 page.



CODE	Description	Unit	20+	10+	1+
CLS144LBK	A4 Portrait	1	1.35	1.45	1.55
CLS143LBK	A3 Portrait	1	3.10	3.20	3.50

## Carlsson Black Laminated Ring Binding A4 and A3

- Carlsson sketchbooks are manufactured in the UK using a high quality cartridge paper.
- Ring bound laminated black cover - easy to wipe clean.
- 140gsm 50 or 60 pages.



CODE	Description	Pages	Unit	20+	10+	1+
CLS144RLB	A4 Landscape	50	1	2.70	2.90	3.10
CLS143RLB	A3 Landscape	50	1	4.90	4.95	5.50
CLS144RPB	A4 Portrait	60	1	3.70	3.90	4.20
CLS143RPB	A3 Portrait	60	1	6.25	6.50	6.95

## Carlsson Hardback Traditional Ring Binding A4 and A3



- Carlsson sketchbooks are manufactured in the UK using a high quality cartridge paper.
- Traditional ring bound hard-backed cover - in black or colours.
- 140gsm 70 page.
- Portrait orientation.

CODE	Description	Unit	20+	10+	1+
CLS144HBK	A4 Black Portrait	1	4.20	4.40	4.80
CLS144HBU	A4 Blue Portrait	1	4.20	4.40	4.80
CLS144HGR	A4 Green Portrait	1	4.20	4.40	4.80
CLS144HRD	A4 Red Portrait	1	4.20	4.40	4.80
CLS143HBK	A3 Black Portrait	1	7.25	7.75	8.25
CLS143HBU	A3 Blue Portrait	1	7.25	7.75	8.25
CLS143HGR	A3 Green Portrait	1	7.25	7.75	8.25
CLS143HRD	A3 Red Portrait	1	7.25	7.75	8.25

## Carlsson Hardback Kraft Cover Ring Binding A4 and A3



- Carlsson sketchbooks are manufactured in the UK using a high quality cartridge paper.
- Ring bound hard-backed kraft cover - students can personalise the cover with their own design.
- 140gsm 70 page.

CODE	Description	Unit	20+	10+	1+
CLS144HKR	A4 Portrait	1	3.80	3.95	4.30
CLS143HKR	A3 Portrait	1	6.75	7.25	8.25

## Carlsson Hardback Jumbo Ring Black A4 and A3



- Carlsson sketchbooks are manufactured in the UK using a high quality cartridge paper.
- Jumbo ring hard-backed cover - extra capacity for work to be inserted.
- 140gsm 80 page.
- Landscape orientation.

CODE	Description	Unit	20+	10+	1+
CLS144JBK	A4 Landscape	1	5.25	5.50	5.95
CLS143JBK	A3 Landscape	1	9.95	10.50	11.25

## Carlsson Hardback Jumbo Ring Kraft Paper A4 and A3



- Manufactured in the UK using a heavy Kraft paper - an alternative and versatile for display or a workbook.
- Jumbo ring hard-backed cover - extra capacity for work to be inserted.
- Kraft 80 page.
- Portrait orientation.

CODE	Description	Unit	20+	10+	1+
CLS144JKR	A4 Portrait	1	5.25	5.50	5.95
CLS143JKR	A3 Portrait	1	7.50	7.75	8.25

## Carlsson Junior Sketch Book A4 Pack of 50



- An inexpensive sketch book for younger years.
- Soft cover A4.
- 90gsm smooth cartridge, 40 page.
- Portrait orientation.
- Pack of 50 books.

CODE	Description	Unit	2+	1+
CLS450JSB	Junior Portrait	Pack of 50	35.50	38.50



### White Drawing Cartridge Paper

Packs of 125 or 250



- A good quality cartridge paper for all media.
- Supplied in three weights - a cost effective 100gsm, the popular 140gsm and a heavy weight 170gsm.
- Available in A4, A3, A2, wrapped in 250's and A1, wrapped in 125's .

CODE	Description	Unit	2+	1+
DRW104WHT	100gsm/A4	Pack of 250	5.50	5.95
DRW103WHT	100gsm/A3	Pack of 250	10.75	11.50
DRW144WHT	140gsm/A4	Pack of 250	7.75	8.50
DRW143WHT	140gsm/A3	Pack of 250	14.50	15.75
DRW142WHT	140gsm/A2	Pack of 250	27.75	29.95
DRW141WHT	140gsm/A1	Pack of 125	27.50	29.75
DRW172WHT	170gsm/A2	Pack of 250	34.50	37.25
DRW171WHT	170gsm/A1	Pack of 125	34.25	36.95

### White Card A3 and A2

Pack of 100



- White Card 230 micron A3 or A2..

CODE	Description	Unit	2+	1+
CRD233WHT	230micron/A3	Pack of 100	9.25	9.95
CRD232WHT	230micron/A2	Pack of 100	16.95	18.50

### Black Card A3 and A2

Pack of 100



- Black Card 180gsm A3 or A2.

CODE	Description	Unit	2+	1+
CRD183BLK	180gsm/A3	Pack of 100	10.75	11.50
CRD182BLK	180gsm/A2	Pack of 100	20.25	21.75
CRD273BLK	270gsm/A3	Pack of 100	15.75	16.95
CRD272BLK	270gsm/A2	Pack of 100	29.95	32.50

### Assorted Pastel & Brite Card

Pack of 200 or 100



- Assorted Pastel and Brite card 230 micron A4, A3 or A2.

CODE	Description	Unit	2+	1+
CRD234ASS	230micron/A4	Pack of 200	9.95	10.75
CRD233ASS	230micron/A3	Pack of 100	9.75	10.50
CRD232ASS	230micron/A2	Pack of 100	18.25	19.75

### White Sugar Paper

Pack of 250



- White Sugar Paper 100gsm A3 and A2 or 140gsm A2

CODE	Description	Unit	2+	1+
SGP103WHT	100gsm/A3	Pack of 250	10.75	11.75
SGP102WHT	100gsm/A2	Pack of 250	20.95	22.75
SGP142WHT	140gsm/A2	Pack of 250	28.25	30.50

### Black Sugar Paper

Pack of 250



- Black Sugar Paper 100gsm A4, A3, A2 and A1 or 140gsm A2.

CODE	Description	Unit	2+	1+
SGP104BLK	100gsm/A4	Pack of 250	5.75	6.25
SGP103BLK	100gsm/A3	Pack of 250	10.75	11.75
SGP102BLK	100gsm/A2	Pack of 250	20.95	22.75
SGP101BLK	100gsm/A1	Pack of 250	40.95	44.25
SGP142BLK	140gsm/A2	Pack of 250	28.25	30.50

### Assorted Sugar Paper

Pack of 250

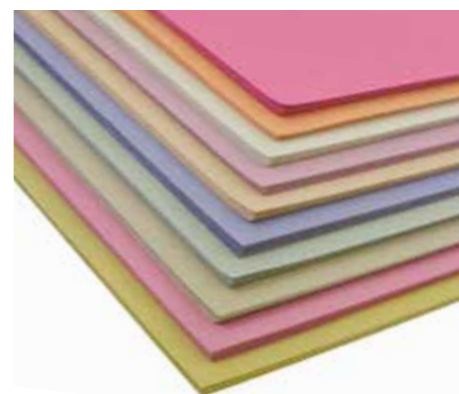

- Sugar Paper 100gsm Assorted Colours A4, A3, A2 and A1.

CODE	Description	Unit	2+	1+
SGP104ASS	100gsm/A4	Pack of 250	5.75	6.25
SGP103ASS	100gsm/A3	Pack of 250	10.75	11.75
SGP102ASS	100gsm/A2	Pack of 250	20.95	22.75
SGP101ASS	100gsm/A1	Pack of 250	40.95	44.25

### Stretched Canvas

6 x 6"



- Mini canvas on a wooden frame. Ideal for use with oil and acrylic paints.
- An economical introduction to painting on canvas for beginners.
- Size 6 x 6" (15cm x 15cm)

CODE	Description	Unit	4+	1+
CVS066PLN	Stretched Canvas 6 x 6	1	1.50	1.65

### Stretched Canvas

10 x 12" or 16 x 24"



- Rectangular canvases are available in three sizes, and are primed and stretched over a wooden frame ready for painting.
- The canvases come complete with wedges to further stretch the frame if necessary.
- The largest size features a centre brace across the frame to increase rigidity.

CODE	Description	Unit	4+	1+
CVS101PLN	Stretched Canvas 10 x 12	1	2.40	2.60
CVS162PLN	Stretched Canvas 16 x 24	1	4.95	5.50

## Apprentice Spiral Sketch Pad A4



- Sketch pad, 90gsm cartridge landscape, spiral bound.
- A4 - 30 sheets.

90gsm				
CODE	Description	Unit	10+	1+
ASS094PAD	A4	1	1.25	1.40

## Acrylic Paint Wiro Pad A3 or A4



- Acrylic painting pad, 240gsm, wiro bound.
- A3 - 12 sheets.

240gsm				
CODE	Description	Unit	5+	1+
AWP244PAD	A4	1	4.50	4.95
AWP243PAD	A3	1	8.25	8.95

## Watercolour Paper Pad A3 or A4



- Features absorbent watercolour paper.
- Great for use with watercolours, pens and brushes.
- 190gsm, acid free, 12 sheets per pad.

190gsm				
CODE	Description	Unit	4+	1+
WCP194PAD	A4	1	3.50	3.75
WCP193PAD	A3	1	5.50	5.95

## Cartridge Spiral Sketch Pad A3 or A4



- Sketch pad, 90gsm cartridge, spiral bound.
- A4 or A3 - 30 sheets.

90gsm				
CODE	Description	Unit	10+	1+
CSS094PAD	A4	1	1.15	1.25
CSS093PAD	A3	1	2.40	2.70

## Oil Painting Wiro Pad A3 or A4



- Oil painting pad, 240gsm, wiro bound.
- A3 or A4 - 12 sheets.

240gsm				
CODE	Description	Unit	5+	1+
OWP244PAD	A4	1	6.25	6.75
OWP243PAD	A3	1	11.75	12.95

## Acrylic Paper Pad A3 or A4



- Features gloss linen textured paper.
- Great for use with acrylics, pens and markers.
- 190gsm, acid free, 12 sheets per pad.

190gsm				
CODE	Description	Unit	4+	1+
ACP194PAD	A4	1	3.50	3.75
ACP193PAD	A3	1	5.50	5.95

## Cartridge Wiro Sketch Pad A2, A3 or A4



- Sketch pad, 135gsm cartridge, spiral bound.
- A2, A3 or A4 - 30 sheets

135gsm				
CODE	Description	Unit	6+	1+
CWS134PAD	A4	1	2.60	2.90
CWS133PAD	A3	1	3.30	3.60
CWS132PAD	A2	1	5.50	5.95

## Watercolour Wiro Pad A3 or A4



- Watercolour pad, 300gsm, wiro bound.
- A3 or A4 - 12 sheets.

300gsm				
CODE	Description	Unit	5+	1+
WWP304PAD	A4	1	6.25	6.75
WWP303PAD	A3	1	10.75	11.75

## Marker Paper Pad A3 or A4



- Features smooth, bleed-proof marker paper.
- For use with markers, technical pens, sketching and drawing pencils.
- 70gsm, acid free, 30 sheets per pad.

70gsm				
CODE	Description	Unit	4+	1+
MKP074PAD	A4	1	2.70	2.85
MKP073PAD	A3	1	5.50	5.95

### Black Paper Pad A3 or A4



- Features smooth, striking black paper.
- Great for use with pens, markers, charcoal, ink, and very effective with white, opaque, metallic and neon colours.
- 135gsm, acid free, 30 sheets per pad.

**135gsm**

CODE	Description	Unit	4+	1+
BKP134PAD	A4	1	<b>3.50</b>	3.75
BKP133PAD	A3	1	<b>5.50</b>	5.95

### Newsprint Paper Pack of 500 Sheets



- A lightweight recycled paper.
- Ideal for economical drawing and sketching.
- 43gsm, 500 sheets per pack.

**Sheet Size 500 x 700mm 43gsm**

CODE	Description	Unit	4+	1+
NPP500PAK	Newsprint	1	<b>28.25</b>	29.95

### Tracedown Graphite Pack of 5 A3 or A4



- A wax-free transfer paper to trace down designs on to most surfaces.
- Clean crisp tracings can be easily erased.
- Great for use on paper, fabric, ceramic, wood and metal.
- Graphite for use on light surfaces.

CODE	Description	Unit	4+	1+
TDS504GPH	Graphite A4	Pack of 5	<b>5.95</b>	6.50
TDS503GPH	Graphite A3	Pack of 5	<b>11.95</b>	12.75

### Mixed Media Pad A3 or A4



- Features an extremely versatile paper which is ideal for use with many mediums.
- For use with acrylic, watercolour, ink, pen, pastels and much more.
- 250gsm, acid free, 30 sheets per pad.

**250gsm**

CODE	Description	Unit	4+	1+
MMP254PAD	A4	1	<b>6.75</b>	7.25
MMP253PAD	A3	1	<b>11.25</b>	11.95

### Tracing Paper Pad A3 or A4



- Highly transparent and superb erasability.
- For use with all types of pens, pencil and drawing inks.
- Available in A4 or A3 - 30 sheets 65gsm.

**65gsm**

CODE	Description	Unit	10+	5+	1+
TRP654PAK	A4	1	<b>2.40</b>	2.50	2.80
TRP653PAK	A3	1	<b>4.90</b>	5.25	5.75

### Drawing Cartridge Paper Roll



- Features smooth, 150gsm white cartridge paper in a wide long length.
- Ideal for drawing and sketching with pencils, charcoal, pens and markers.

**841mm x 10m roll 150gsm**

CODE	Description	Unit	4+	1+
DRW150RLL	Cartridge Roll	1	<b>13.75</b>	14.50

### Calligraphy Paper Pad A4

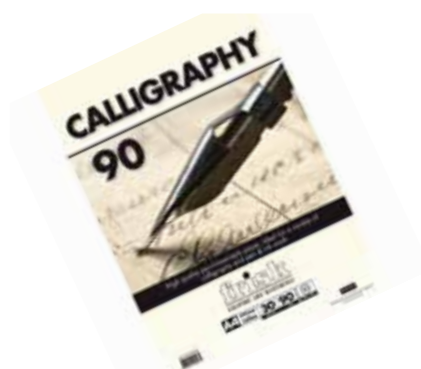

- Features parchment style paper.
- Ideal for use with calligraphy pens and ink.
- 90gsm, acid free, 30 sheets per pad.

**90gsm**

CODE	Description	Unit	4+	1+
CGP094PAD	A4	1	<b>5.50</b>	5.95

### Tracedown White Pack of 5 A3 or A4



- A wax-free transfer paper to trace down designs on to most surfaces.
- Clean crisp tracings can be easily erased.
- Great for use on paper, fabric, ceramic, wood and metal.
- White for use on dark surfaces.

CODE	Description	Unit	4+	1+
TDS504WHT	White A4	Pack of 5	<b>5.95</b>	6.50
TDS503WHT	White A3	Pack of 5	<b>11.95</b>	12.75

### Colour Paper Black, Pastel or Rainbow A3 or A4

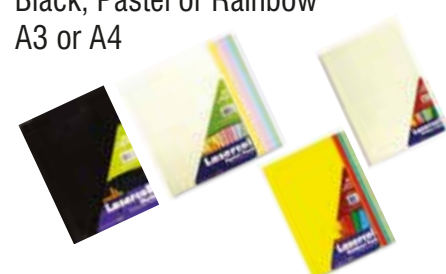

- Black paper, 80gsm. A4 - pack of 50 sheets.
- Pastel paper, 80gsm, in pastel rainbow colours. A4 - pack of 250.
- Rainbow paper, 80gsm, in bright rainbow colours. Available in A4 (Pack of 250) or A3 (Pack of 100).

CODE	Description	Unit	10+	5+	1+
CLP804BLK	A4 Black 80gsm	Pk 50	<b>1.50</b>	1.60	1.75
CLP804PAS	A4 Pastel 80gsm	Pk 250	<b>5.75</b>	5.95	6.75
CLP804RBW	A4 Rainbow 300gsm	Pk 250	<b>7.75</b>	8.25	9.25
CLP803RBW	A3 Rainbow 300gsm	Pk 100	<b>6.75</b>	7.25	7.95

## Card White A2, A3 or A4



- White card 160gsm, for craft and modelling.
- Available in A4 (Pack of 50), A3 (Pack of 50) and A2 (Pack of 25) sizes.

160gsm

CODE	Description	Unit	10+	5+	1+
CRD164WHT	A4	Pack of 50	2.70	2.90	3.20
CRD163WHT	A3	Pack of 50	5.50	5.75	6.50
CRD162WHT	A2	Pack of 25	5.50	5.75	6.50

## Card Black A2, A3 or A4



- Black card 160gsm, for craft and modelling.
- Available in A4 (Pack of 100), A3 (Pack of 20) and A2 (Pack of 20) sizes.

160gsm

CODE	Description	Unit	10+	5+	1+
CRD164BLK	A4	Pack of 100	4.70	4.95	5.50
CRD163BLK	A3	Pack of 20	2.40	2.50	2.80
CRD162BLK	A2	Pack of 20	5.75	5.95	6.75

## Rainbow Bright Card A2, A3 or A4



- Rainbow coloured card 160gsm, for craft and modelling.
- Available in A4 (Pack of 50), A3 (Pack of 50) and A2 (Pack of 25) sizes.

160gsm

CODE	Description	Unit	10+	5+	1+
CRD164RBW	A4	Pack of 50	2.40	2.50	2.80
CRD163RBW	A3	Pack of 50	5.50	5.95	6.50
CRD162RBW	A2	Pack of 25	3.80	3.90	4.10

## Rainbow Pastel Card A4 Assorted Colours



- Pastel rainbow coloured card 160gsm, for craft and modelling.
- A4 - pack of 50.

160gsm

CODE	Description	Unit	10+	5+	1+
CRD164PAS	Assorted	Pack of 50	2.50	2.70	2.95

## Fluorescent Card A2, A3 or A4



- Fluorescent coloured card 155/160gsm, for craft and modelling.
- Available in A4 (Pack of 40), A3 (Pack of 20) and A2 (Pack of 20) sizes.

CODE	Description	Unit	10+	5+	1+
CRD164FLO	A4 160gsm	Pack of 40	3.20	3.40	3.80
CRD153FLO	A3 155gsm	Pack of 20	3.95	4.20	4.70
CRD152FLO	A2 155gsm	Pack of 20	5.25	5.50	5.95

## Heavy Card A4 White, Gold or Silver



- Heavy card 200/210gsm, in white, gold or silver.
- Available in A4 (Pack of 50), A3 (Pack of 25) and A2 (Pack of 25) sizes.

CODE	Description	Unit	10+	5+	1+
CRD204WHT	White A4 200gsm	Pk of 50	5.75	6.25	6.95
CRD214GLD	Gold A4 210gsm	Pk of 25	6.25	6.75	7.50
CRD214SLV	Silver A4 210gsm	Pk of 25	5.50	5.75	6.50

## Special Finish Card A4 Pack of 100



- Extra thick textured white card 300gsm.
- A4 - pack of 100.

300gsm

CODE	Description	Unit	4+	1+
CRD304SMF	Smooth A4	Pack of 100	11.75	12.75
CRD304HAF	Hammer A4	Pack of 100	10.25	10.95
CRD304LNF	Linen A4	Pack of 100	7.95	8.50

## Craft Card A4

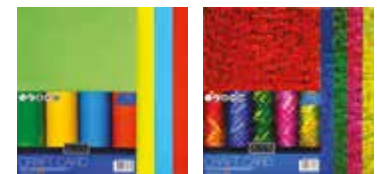
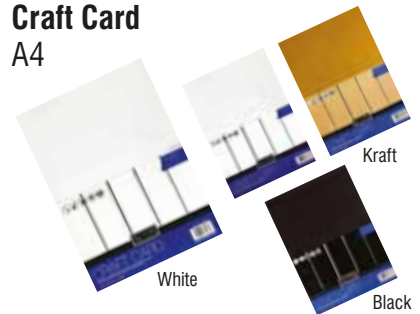

Brights

Holographic

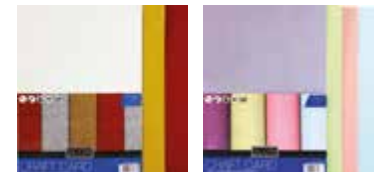

Glitter

Pastels



Mirror

- Craft card 220gsm, in a wide range of different finishes.
- A4 in packs of 8 (Mirror), 10 or 15, and A3 white as a pack of 10.

220gsm

CODE	Description	Unit	12+	6+	1+
CRD224WHT	White A4	Pack of 15	1.30	1.35	1.50
CRD223WHT	White A3	Pack of 10	2.90	3.10	3.50
CRD224BLK	Black A4	Pack of 10	3.90	4.30	4.95
CRD224RBW	Brights A4	Pack of 10	3.60	3.90	4.50
CRD224GTT	Glitter A4	Pack of 10	2.30	2.40	2.70
CRD224HLG	Holog. A4	Pack of 10	1.30	1.35	1.50
CRD224KRF	Kraft A4	Pack of 10	1.15	1.25	1.50
CRD224PAS	Pastel A4	Pack of 10	1.60	1.75	1.95

### Transparent Cellophane Roll



- Clear cellophane for wrapping and decorative use.
- 20m X 700mm Roll.

CODE	Description	Unit	6+	1+
CEL720TRP	Cellophane	1	4.10	4.50

### Tissue Paper Pack of 5



TSP575CRM	Cream
TSP575DGR	Dark Green
TSP575FCH	Fuchsia
TSP575HPK	Hot Pink
TSP575LEM	Lemon
TSP575LGR	Light Green
TSP575LLC	Lilac
TSP575ORG	Orange
TSP575PUR	Purple
TSP575RED	Red

- Coloured tissue paper for crafts.
- Wide range of colours.
- Sheet size 500 x 700mm - Pack of 5

CODE	Description	Unit	10+	5+	1+
TSP575CRM	Cream	Pack of 5	1.50	1.75	1.95
TSP575DGR	Dark Green	Pack of 5	1.50	1.75	1.95
TSP575FCH	Fuchsia	Pack of 5	1.50	1.75	1.95
TSP575HPK	Hot Pink	Pack of 5	1.50	1.75	1.95
TSP575LEM	Lemon	Pack of 5	1.50	1.75	1.95
TSP575LGR	Light Green	Pack of 5	1.50	1.75	1.95
TSP575LLC	Lilac	Pack of 5	1.50	1.75	1.95
TSP575ORG	Orange	Pack of 5	1.50	1.75	1.95
TSP575PUR	Purple	Pack of 5	1.50	1.75	1.95
TSP575RED	Red	Pack of 5	1.50	1.75	1.95

### Crepe Paper



CRP502BBU	Baby Blue
CRP502PNK	Baby Pink
CRP502DAF	Daffodil
CRP502DBU	Dark Blue
CRP502DGR	Dark Green
CRP502GLD	Gold
CRP502LLC	Lilac
CRP502LGR	Lime Green
CRP502ORG	Orange
CRP502RED	Scarlet Red
CRP502WHT	White
CRP502SLV	Silver

- Crepe paper 17gsm, in a useful large size for many craft and art applications.
  - Wide range of colours.
- Sheet size:**  
500mm x 2.5m 17gsm

CODE	Description	Unit	10+	5+	1+
CRP502BBU	Baby Blue	1	0.60	0.65	0.70
CRP502PNK	Baby Pink	1	0.65	0.65	0.75
CRP502BLK	Black	1	0.60	0.65	0.70
CRP502DAF	Daffodil	1	0.60	0.65	0.70
CRP502DBU	Dark Blue	1	0.60	0.65	0.70
CRP502DGR	Dark Green	1	0.60	0.65	0.70
CRP502GLD	Gold	1	1.50	1.60	1.80
CRP502LLC	Lilac	1	0.60	0.65	0.70
CRP502LGR	Lime Green	1	0.55	0.60	0.65
CRP502ORG	Orange	1	0.60	0.65	0.70
CRP502RED	Scarlet Red	1	0.60	0.65	0.70
CRP502WHT	White	1	0.60	0.65	0.70
CRP502SLV	Silver	1	1.50	1.60	1.80

### Crepe Paper Assorted Colours Pack of 10



- Crepe paper 17gsm, in a useful large size for many craft and art applications.
- Wide range of colours.

**500mm x 2.0m per colour 17gsm**

CODE	Description	Unit	5+	1+
CRP502ASS	Assorted	Pack of 10	4.20	4.70

### Felt Roll



- Quality felt in a roll.
- For creative craft use.

**450mm x 5m**

CODE	Description	Unit	5+	1+
FLT455BLK	Black	1	6.75	7.50
FLT455BRN	Brown	1	6.75	7.50
FLT455GRN	Green	1	6.75	7.50
FLT455ORG	Orange	1	6.75	7.50
FLT455PNK	Pink	1	6.75	7.50
FLT455PUR	Purple	1	6.75	7.50
FLT455RED	Red	1	6.75	7.50
FLT455WHT	White	1	6.75	7.50
FLT455YEL	Yellow	1	6.75	7.50

## Dual Mount Black/White A1, A2, A3 or A4



- Double-sided dual finish, with black and white options.
- Perfect for all professional and creative applications.
- 1250 micron, acid free.

CODE	Description	Unit	4+	1+
DMB121BKW	Dual A1	1	<b>3.40</b>	3.50
DMB122BKW	Dual A2	1	<b>1.75</b>	1.85
DMB123BKW	Dual A3	1	<b>0.90</b>	0.95
DMB124BKW	Dual A4	1	<b>0.50</b>	0.55

## Neoprene Sheet Pack of 10



- A pack of 10 neoprene sheets in assorted colours.
- A tactile material that is easy to cut with scissors or a knife.
- Ideal for collage work, modelling and jewellery making.
- Dimensions 25cm x 30cm, thickness approximately 2mm.

CODE	Description	Unit	4+	1+
NSH320SET	Neoprene Sheet	Pack of 10	<b>2.90</b>	3.20

## Can Art Chrome Effect Spray Paint



- Chrome effect spray paint with excellent coverage and fast drying time.
- Available in Gold and Silver.

CODE	Description	Unit	6+	1+
CNA400CGL	Gold 400ml	1	<b>6.75</b>	7.50
CNA400CSV	Silver 400ml	1	<b>6.75</b>	7.50

## Can Art Colours



- Decorative spray paint for use indoor or outdoor.
- Available in a wide range of colours.
- 400ml.

CODE	Description	Unit	6+	1+
CNA400BGE	Beige	1	<b>6.75</b>	7.50
CNA400BVT	Blueberry Violet	1	<b>6.75</b>	7.50
CNA400BRN	Chocolate Brown	1	<b>6.75</b>	7.50
CNA400FGR	Fir Green	1	<b>6.75</b>	7.50
CNA400HVT	Heather Violet	1	<b>6.75</b>	7.50
CNA400JBK	Jet Black	1	<b>6.75</b>	7.50
CNA400LGR	Lutecia Green	1	<b>6.75</b>	7.50
CNA400PWT	Pure White	1	<b>6.75</b>	7.50
CNA400MWT	Pure White Matt	1	<b>6.75</b>	7.50
CNA400PRD	Purple Red	1	<b>6.75</b>	7.50
CNA400MBK	Pure Traffic Matt Black	1	<b>6.75</b>	7.50
CNA400TRD	Pure Traffic Red	1	<b>6.75</b>	7.50
CNA400TRB	Pure True Blue	1	<b>6.75</b>	7.50
CNA400YOR	Pure Yellow/Orange	1	<b>6.75</b>	7.50

## Can Art Colours Metallic Spray Paint 400ml



- Metallic effect spray paint with excellent coverage and fast drying time.
- Available in Gold and Silver.

CODE	Description	Unit	6+	1+
CNA400GLD	Gold 400ml	1	<b>6.75</b>	7.50
CNA400SLV	Silver 400ml	1	<b>6.75</b>	7.50

## Can Art Colours Spray Primer



- Primer for use prior to colour spraying.
- Available in 2 versions - for general use and one for plastics.

CODE	Description	Unit	6+	1+
CNA400PRP	Plastic 400ml	1	<b>5.50</b>	6.25
CNA400PRC	Clear 400ml	1	<b>6.75</b>	7.50

## Can Art Spray Varnish High Gloss or Matt



- Clear varnish, a final coat to protect the surface.
- Available in High Gloss or Matt.

CODE	Description	Unit	6+	1+
CNA400VRG	High Gloss 400ml	1	<b>6.75</b>	7.50
CNA400VRM	Matt 400ml	1	<b>6.75</b>	7.50

### Ready Mixed Poster Paint Assorted Colours Single



- Quality ready mixed paint with fabulous colour lay down.
- Water soluble colour may be used straight from the bottle or diluted.
- Colours are fully inter-mixable with other Artmix or PVA to achieve a glossy finish.
- Dries to a matt finish.
- Non-toxic, safe for children. Wheat, gluten and dairy free.

#### 600ml

CODE	Description	Unit	6+	1+
RMP617SBU	Sky Blue	1	1.25	1.35
RMP620LEM	Lemon	1	1.25	1.35
RMP621BYL	Brilliant Yellow	1	1.25	1.35
RMP622ORG	Orange	1	1.25	1.35
RMP623VER	Vermillion	1	1.25	1.35
RMP624BRD	Brilliant Red	1	1.25	1.35
RMP625CRM	Crimson	1	1.25	1.35
RMP627PUR	Purple	1	1.25	1.35
RMP629BBU	Brilliant Blue	1	1.25	1.35
RMP630CBU	Cobalt Blue	1	1.25	1.35
RMP631PBU	Prussian Blue	1	1.25	1.35
RMP633TUR	Turquoise	1	1.25	1.35
RMP635VRD	Viridian	1	1.25	1.35
RMP636BGR	Brilliant Green	1	1.25	1.35
RMP637LGR	Leaf Green	1	1.25	1.35
RMP638BLK	Black	1	1.25	1.35
RMP639UMB	Burnt Umber	1	1.25	1.35
RMP640BSN	Burnt Sienna	1	1.25	1.35
RMP641YLO	Yellow Ochre	1	1.25	1.35
RMP643WHT	White	1	1.25	1.35
RMP603PNK	Pink	1	1.25	1.35



#### 5 Litres

CODE	Description	Unit	1+
RMP215BYL	Brilliant Yellow	1	7.75
RMP245BRD	Brilliant Red	1	7.75
RMP295BBU	Brilliant Blue	1	7.75
RMP365BGR	Brilliant Green	1	7.75
RMP385BLK	Black	1	7.75
RMP435WHT	White	1	7.75

### Ready Mixed Poster Paint Assorted Colours Pack of 6

- Quality ready mixed paint with fabulous colour lay down.
- Water soluble colour may be used straight from the bottle or diluted.
- Colours are fully inter-mixable with other Artmix or PVA to achieve a glossy finish.
- Dries to a matt finish.
- Non-toxic, safe for children. Wheat, gluten and dairy free



#### 6 x 600ml

CODE	Description	Unit	1+
RMP606ASS	Assorted	Pack of 6	6.95

#### Pack of 12



#### 12 x 600ml

CODE	Description	Unit	1+
RMP612ASS	Assorted	Pack of 12	13.95

#### Pack of 20



#### 20 x 600ml

CODE	Description	Unit	1+
RMP620ASS	Assorted	Pack of 20	21.95

### Metallic Ready Mixed Poster Paint Pack of 6



- Quality ready mixed paint with fabulous colour lay down.
- Water soluble colour may be used straight from the bottle or diluted.
- Colours are fully inter-mixable with other Artmix or PVA to achieve a glossy finish.
- Dries to a matt finish.
- Non-toxic, safe for children. Wheat, gluten and dairy free.

#### 6 x 600ml

CODE	Description	Unit	1+
RMP606MET	Metallics	Pack of 6	11.95

### Fluorescent Ready Mixed Poster Paint Pack of 6



- Quality ready mixed paint with fabulous colour lay down.
- Water soluble colour may be used straight from the bottle or diluted.
- Colours are fully inter-mixable with other Artmix or PVA to achieve a glossy finish.
- Dries to a matt finish.
- Non-toxic, safe for children. Wheat, gluten and dairy free.

#### 6 x 600ml

CODE	Description	Unit	1+
RMP606FLU	Fluorescent	Pack of 6	11.25

#### SEE CONSUMABLES PAGE 58

### Metal Paints



Paint

## 12-Disk Watercolour Set



- 12 ready-mixed watercolour discs in a plastic case with hinged transparent lid.
- Also contains a fine synthetic brush..

CODE	Description	Unit	4+	1+
PBL120SET	12-Block	1	2.30	2.50

## 6-Block Watercolour Palette Size 1



- Sturdy plastic palette containing 6 watercolour blocks.
- Colours include black, white, red, yellow, blue, green.
- Each block is 44mm in diameter, and 16mm thick.

CODE	Description	Unit	4+	1+
PBL644SET	Size 1	1	2.90	3.10

## 6-Block Watercolour Palette Size 2



- Sturdy plastic palette containing 6 watercolour blocks.
- Colours include black, white, red, yellow, blue, green.
- Each block is 58mm in diameter, and 19mm thick.

CODE	Description	Unit	4+	1+
PBL658SET	Size 2	1	3.40	3.70

## Fabric Paint Assorted Colours Pack of 6



- Water based fabric paint which can be painted directly onto fabric.
- All colours are inter-mixable.
- Make permanent by ironing on the reverse.
- Recommend washing new fabric through before using paints on them.
- Non-toxic, safe for children. Wheat, gluten and dairy free.

6 x 300ml

CODE	Description	Unit	1+
FAB306ASS	Assorted	Pack of 6	11.75

## Pearl Fabric Paint Pack of 6



- Water based fabric paint which can be painted directly onto fabric.
- All colours are inter-mixable.
- Make permanent by ironing on the reverse.
- Recommend washing new fabric through before using paints on them.
- Non-toxic, safe for children. Wheat, gluten and dairy free.

6 x 300ml

CODE	Description	Unit	1+
FAB306PRL	Pearl	Pack of 6	13.50

## Fluorescent Fabric Paint Pack of 6



- Water based fabric paint which can be painted directly onto fabric.
- All colours are inter-mixable.
- Make permanent by ironing on the reverse.
- Recommend washing new fabric through before using paints on them.
- Non-toxic, safe for children. Wheat, gluten and dairy free.

6 x 300ml

CODE	Description	Unit	1+
FAB306FLU	Fluo	Pack of 6	13.50

## Pentel Fabric Fun Pastel Dye Sticks Set 15 Piece



- For use on natural, absorbent fabric
- Wash out while still wet, but permanent once dried/ironed.
- 15 assorted colours.

CODE	Description	Unit	12+	1+
FAB015PAS	15 Piece Set	1	5.50	5.95

## Marbling Ink Pack of 6



- Great quality, ready to use and create beautiful unique marbled patterns.
- Easy to use straight from the dropper bottle. Drop the ink onto a tray of clean water, blow or swirl the ink and then lay the paper onto the surface and gently remove.
- Shake bottles well before use, making sure the cap is firmly in place first.
- Full easy to follow instructions on the box.
- Non-toxic, safe for children. Wheat, gluten and dairy free.

6 x 25ml

CODE	Description	Unit	1+
MRB256ASS	Assorted	Pack of 6	6.25

## Glitter Paint Assorted Colours Pack of 6



- High glitter content to add impact to any craft activity.
- Great to use on virtually any surface, paper, card, fabric, ceramic and wood.
- Non-toxic, safe for children. Wheat, gluten and dairy free.

6 x 300ml

CODE	Description	Unit	1+
GPT306ASS	Assorted	Pack of 6	11.75



### 12-Block Watercolour Tin



- Durable metal tin contains 12 ready mixed paint blocks.
- Inside surface of lid is coloured white and contains 5 separate mixing sections.
- Double size white block for colour mixing.
- Paper diagram listing colours.
- Tin dimensions 223 x 54mm.

CODE	Description	Unit	4+	1+
PNT120WTC	12-Block	1	2.30	2.50

### Oil Pastel Set 12 Piece



- Ideal introductory set of oil pastels in 12 strong colours.
- Easy to blend and highly opaque for vivid mark making.
- Approx. 1cm diameter, length 7cm.

CODE	Description	Unit	4+	1+
PNT120OIL	Oil Pastels	12 Piece	2.20	2.40

### Daler Rowney Gouache Set 12 Piece



- A Gouache Set in a range of colours which can be used to paint on all conventional watercolour surfaces
- Formulated to give opaque colours with strong covering power

12 x12ml

CODE	Description	Unit	3+	1+
DLR120GST	Gouache Set	12 Piece	6.75	7.25

### 18-Block Watercolour Tin



- Durable metal tins containing 18 ready mixed watercolour paint blocks.
- Inside surface of lid is coloured white and contains 4 separate mixing sections.
- Paper diagram listing colours.
- Tin dimensions 215 x 95mm.

CODE	Description	Unit	4+	1+
PNT180WTC	18-Block	1	3.90	4.30

### Soft Pastel Set 24 Piece



- Soft pastels in 24 assorted colours.
- 1cm square cross-section allows for a variety of marks to be made, and reduces breakages from pastels rolling off tables.
- Length approx. 6cm.

CODE	Description	Unit	4+	1+
PNT240PST	Pastel Set	24 Piece	5.75	6.25

### Acrylic Paint Single, Packs of 6 or 10



- Scola System Acrylic is premium product using only pure acrylic resin, (many cheaper "school grade" acrylics contain no acrylic or just a cheap co-polymer).
- Thick creamy viscosity which allows easy use of a palette knife for impasto work.
- Retains brush strokes and facilitates colour mixing and blending.
- Can be thinned down for water colour techniques, staining and dry brush work.
- Non-toxic, safe for children. Wheat, gluten and dairy free.
- \*Denotes colours in assorted pack of 6 x 500ml.
- \*Denotes colours in assorted pack of 10 x 500ml.

500ml

CODE	Description	Unit	6+	1+
APT517SKY	Sky Blue	1	2.50	3.25
APT520LEM	Lemon <sup>†</sup>	1	2.50	3.25
APT521BYL	Brilliant Yellow* <sup>†</sup>	1	2.50	3.25
APT522ORG	Orange	1	2.50	3.25
APT524BRD	Brilliant Red* <sup>†</sup>	1	2.50	3.25
APT528VLT	Violet	1	2.50	3.25
APT529BBU	Brilliant Blue* <sup>†</sup>	1	2.50	3.25
APT536BGR	Brilliant Green* <sup>†</sup>	1	2.50	3.25
APT537LFG	Leaf Green	1	2.50	3.25
APT538BLK	Black* <sup>†</sup>	1	2.50	3.25
APT540BSN	Burnt Sienna <sup>†</sup>	1	2.50	3.25
APT543WHT	White*	1	2.50	3.25
APT564DRD	Dark Red	1	2.50	3.25
APT572CYN	Cyan Blue	1	2.50	3.25
APT544MAG	Magenta <sup>†</sup>	1	2.50	3.25
APT506ASS	Assorted	Pack of 6*	14.50	
APT510ASS	Assorted	Pack of 10 <sup>†</sup>	24.25	

### 24-Block Watercolour Tin



- Durable metal tins containing 24 ready mixed watercolour paint blocks.
- Inside surface of lid is coloured white and contains 4 separate mixing sections.
- Paper diagram listing colours.
- Tin dimensions 215 x 95mm.

CODE	Description	Unit	4+	1+
PNT240WTC	24-Block	1	4.10	4.50

### Daler Rowney Aquafine Watercolour Set 18 Piece



- Aquafine offers brilliant, transparent, free-flowing watercolours ideal for students.
- Traditionally manufactured in England, and stem from Daler-Rowney's heritage as a world reference in watercolour since the 19th century.
- Rich, free-flowing transparent colour, with excellent tinting strength and working properties.
- All colours can be used to produce beautiful and delicate washes.

CODE	Description	Unit	3+	1+
DLR180WST	Tin of 18	18 Piece	12.95	13.75

## Daler Rowney Graduate Acrylic Paint



- Daler Rowney's Graduate range have good pigment strength and feature bright and strong colours, including metallic colours.
- Easy to brush onto any paper surface, primed board or canvas.
- Fast-drying, durable and flexible, so paintings will last a long time - can be loosely rolled and stored without fear of cracking.
- Fast drying means artwork can be stored away shortly after an art class has been completed, and will not smudge if water is spilled on the surface of the painting.
- Water-based and contain no solvents. In accordance with EC labelling regulations, all colours are classified as non-dangerous for use.
- Squeezable pot that has a lid with a unique valve mechanism and stay-clean technology to dispense the colour, minimising the waste.

### 500ml

CODE	Description	Unit	3+	1+
DLR011GRA	White	1	8.50	8.95
DLR024GRA	Buff Titanium	1	8.50	8.95
DLR026GRA	Black	1	8.50	8.95
DLR065GRA	Payne's Grey	1	8.50	8.95
DLR110GRA	Cobalt Blue Hue	1	8.50	8.95
DLR123GRA	Ultramarine Blue	1	8.50	8.95
DLR130GRA	Coeruleum Hue	1	8.50	8.95
DLR143GRA	Phthalo Blue	1	8.50	8.95
DLR201GRA	Burnt Sienna	1	8.50	8.95
DLR225GRA	Burnt Umber	1	8.50	8.95
DLR247GRA	Raw Umber	1	8.50	8.95
DLR343GRA	Hooker's Green	1	8.50	8.95
DLR355GRA	Leaf Green	1	8.50	8.95
DLR375GRA	Sap Green	1	8.50	8.95
DLR433GRA	Purple	1	8.50	8.95
DLR500GRA	Cadmium Red Hue	1	8.50	8.95
DLR504GRA	Cadmium Red Deep Hue	1	8.50	8.95
DLR542GRA	Crimson	1	8.50	8.95
DLR588GRA	Vermilion	1	8.50	8.95
DLR605GRA	Cadmium Yellow Hue	1	8.50	8.95
DLR618GRA	Cadmium Yellow Deep Hue	1	8.50	8.95
DLR619GRA	Cadmium Orange Hue	1	8.50	8.95
DLR634GRA	Naples Yellow	1	8.50	8.95
DLR651GRA	Lemon Yellow	1	8.50	8.95
DLR690GRA	Yellow Ochre	1	8.50	8.95
DLR701GRA	Gold Imit	1	8.50	8.95
DLR702GRA	Silver Imit	1	8.50	8.95

## Acrylic Gesso Canvas Primer



- White acrylic Gesso, rich quality canvas primer.
- Fast drying, non-yellowing and flexible.

CODE	Description	Unit	10+	5+	1+
GES500WHT	500ml	1	7.50	7.95	8.75

## Georgian Water Mixable Oil Paint



- Mirrors traditional oil colours and can be used for impasto techniques, or thinned down with water to create a watercolour effect.
- Can be thinned, mixed, and washed using water, ideal for use in a classroom environment.
- High levels of lightfastness, pigment load, and durability.
- Surface-dry between 5 and 7 days, and no colour shift from wet to dry.

### 200ml

CODE	Description	Unit	3+	1+
DLR009GWM	Titanium White	1	10.95	11.95
DLR024GWM	Buff Titanium	1	10.95	11.95
DLR034GWM	Ivory Black	1	10.95	11.95
DLR065GWM	Payne's Grey	1	10.95	11.95
DLR110GWM	Blue Hue	1	10.95	11.95
DLR112GWM	Coeruleum Hue	1	10.95	11.95
DLR123GWM	French Ultramarine	1	10.95	11.95
DLR135GWM	Prussian Blue	1	10.95	11.95
DLR221GWM	Burnt Sienna	1	10.95	11.95
DLR223GWM	Burnt Umber	1	10.95	11.95
DLR247GWM	Raw Umber	1	10.95	11.95
DLR350GWM	Light Hue	1	10.95	11.95
DLR363GWM	Olive Green	1	10.95	11.95
DLR375GWM	Sap Green	1	10.95	11.95
DLR382GWM	Viridian Hue	1	10.95	11.95
DLR503GWM	Red Hue	1	10.95	11.95
DLR515GWM	Alizarin Hue	1	10.95	11.95
DLR561GWM	Rose Madder	1	10.95	11.95
DLR577GWM	Flesh Tint	1	10.95	11.95
DLR617GWM	Pale Hue	1	10.95	11.95
DLR620GWM	Yellow Hue	1	10.95	11.95
DLR635GWM	Naples Yellow	1	10.95	11.95
DLR651GWM	Lemon Yellow	1	10.95	11.95
DLR663GWM	Yellow Ochre	1	10.95	11.95

## Georgian Water Mixable Oil Paint Set 10 Piece



- The viscosity and smooth texture of the colours out of the tube mirror traditional oil colours and can be used for impasto techniques, or thinned down with water they can create wash effects similar to watercolours.
- Can be thinned, mixed, and washed using water, ideal for use in a classroom environment.
- High levels of lightfastness, pigment load, and durability.
- Surface-dry between 5 and 7 days, and no colour shift from wet to dry.

### 10 x 37ml

CODE	Description	Unit	3+	1+
DLR650GWM	Set	10 Piece	32.75	35.50

## Daler Rowney Acrylic Inks



- Lightfastness and fully intermixable colours makes them ideal for the production of pictures for permanent display.
- Colours can be substantially diluted to achieve the most subtle of tones, very similar in character to watercolour.
- Dries to a water-resistant film on virtually all surfaces and successive layers of colour can be laid over.
- Works well through airbrushes and technical pens.

### 29.5ml

CODE	Description	Unit	3+	1+
DLR011ACI	White	1	4.95	5.50
DLR028ACI	Black India	1	4.95	5.50
DLR065ACI	Payne's Grey	1	4.95	5.50
DLR100ACI	Fluorescent Blue	1	4.95	5.50
DLR120ACI	Process Cyan	1	4.95	5.50
DLR134ACI	Prussian Blue Hue	1	4.95	5.50
DLR145ACI	Turquoise	1	4.95	5.50
DLR151ACI	Marine Blue	1	4.95	5.50
DLR222ACI	Antelope Brown	1	4.95	5.50
DLR223ACI	Burnt Umber	1	4.95	5.50
DLR251ACI	Sepia	1	4.95	5.50
DLR335ACI	Emerald Green	1	4.95	5.50
DLR348ACI	Light Green	1	4.95	5.50
DLR349ACI	Fluorescent Green	1	4.95	5.50
DLR363ACI	Olive Green	1	4.95	5.50
DLR412ACI	Process Magenta	1	4.95	5.50
DLR437ACI	Purple Lake	1	4.95	5.50
DLR517ACI	Flame Red	1	4.95	5.50
DLR538ACI	Fluorescent Pink	1	4.95	5.50
DLR544ACI	Fluorescent Red	1	4.95	5.50
DLR567ACI	Scarlet	1	4.95	5.50
DLR651ACI	Lemon Yellow	1	4.95	5.50
DLR653ACI	Fluorescent Orange	1	4.95	5.50
DLR663ACI	Yellow Ochre	1	4.95	5.50
DLR681ACI	Fluorescent Yellow	1	4.95	5.50
DLR701ACI	Gold Imit	1	4.95	5.50
DLR702ACI	Silver Imit	1	4.95	5.50

### Daler Rowney Gold Taklon Brush Set 10 Piece



- Daler-Rowney Gold Taklon brushes that have been specially designed for working with acrylic colours.
- Made with golden Taklon, a synthetic material formulated to exhibit the qualities of the finest hair brushes.
- A variety of shapes and sizes to fit almost any need - includes fan, rounds, flats, rigger, chisel and filbert.
- Supplied in a zip-up fabric case.

CODE	Description	Unit	3+	1+
DLR100GTK	Taklon	10 Piece	<b>10.75</b>	11.75

### Red Synthetic Sable Round and Flat Set of 10



- Set of 10 synthetic sable brushes containing a mixture of round, flat and filbert tip brushes.
- Fine synthetic filaments with sharp edges and a good spring.
- Set contains sizes 5/0, 0, 1, 3, 5 round; sizes 2, 6, 10 flat; sizes 4, 8 filbert.
- Ideal for use with watercolour and acrylic paints.
- Approximate overall lengths 17cm - 19cm.

CODE	Description	Unit	4+	1+
SBR010SET	Red Synthetic Sable Set	10 Piece	<b>5.50</b>	5.95

### Synthetic General Brushes Set of 144



- A set of 144 economical synthetic brushes supplied in a clear plastic cylinder.
- 6 assorted colours and shapes.
- Approximate brush length 17.5cm.

CODE	Description	Unit	4+	1+
GBR144SET	Synthetic Brushes Set	144 Piece	<b>12.95</b>	13.95

### Hog Short Flat Pack of 30



- Hog Bristle Brushes with a flat tip and a short lacquered handle.
- The hair is firm and durable and suitable for use with most kinds of paints.
- The split end characteristics of bristle enable large amounts of paint to be held on the brush.
- Set of 30 contains:- 10 each of sizes 8, 14 and 18.

CODE	Description	Unit	4+	1+
BRH030FLT	Hog Short Flat	Pack of 30	<b>9.95</b>	10.75

### Hog Long Flat Pack of 60



- Hog Bristle Brushes with a flat tip and a long lacquered handle.
- The hair is firm and durable and suitable for use with most kinds of paints.
- The split end characteristics of bristle enable large amounts of paint to be held on the brush.
- Approximate overall length 29cm - 34cm, depending on size.
- Set of 60 contains 10 each of sizes 4, 6, 8, 10, 14 and 18.

CODE	Description	Unit	4+	1+
BRH060FLT	Hog Long Flat	Pack of 60	<b>21.25</b>	22.95

### Hog Brush Pack of 30



- Set of 30 short handle round tip bristle brushes with coloured handles.
- Set of 30 contains 10 each of sizes 8, 12, and 18 with coloured handles.

CODE	Description	Unit	4+	1+
BRH030SRD	Hog S R (8/12/18)	Pack of 30	<b>11.50</b>	12.50

### Hog Brush Pack of 30



- Hog Bristle Brushes with a round tip and a long lacquered handle.
- The hair is firm and durable and suitable for use with most kinds of paints.
- The split end characteristics of bristle enable large amounts of paint to be held on the brush.
- Set of 30 contains 10 each of sizes 8, 12 and 18.

CODE	Description	Unit	4+	1+
BRH030LRD	Hog L R (8/12/18)	Pack of 30	<b>11.95</b>	12.95

### Soft Hair with Yellow Handle Pack of 50



- Soft natural brushes best used with watercolour paints.
- Ideal for shading, softening edges and painting backgrounds.
- Available as a boxed set of 50 containing sizes 2, 4, 6, 8 and 10.
- Approximate overall length 18cm - 21cm, depending on size.

CODE	Description	Unit	4+	1+
SHB050PAK	Soft Hair	Pack of 50	<b>20.25</b>	22.25

### Sable Substitute Brush Packs of 10 and Pack of 50 Assorted



- The synthetic sable (also called sable substitute) brushes are suitable for water-colour, oil and acrylic paints.
- They combine a traditional spring with a fine flexible point and are used for a variety of painting techniques, including glass, silk, and pottery painting.
- Approximate overall length 17.5cm - 20.5cm, depending on size.

CODE	Description	Unit	4+	1+
SBR210PAK	Size 2	Pack of 10	<b>3.60</b>	3.95
SBR410PAK	Size 4	Pack of 10	<b>4.60</b>	4.95
SBR610PAK	Size 6	Pack of 10	<b>5.75</b>	6.25
SBR810PAK	Size 8	Pack of 10	<b>7.95</b>	8.75
SBR100PAK	Size 10	Pack of 10	<b>10.75</b>	11.75
SBR050PAK	Assorted	Pack of 50	<b>19.95</b>	21.75

## Flat Synthetic Sable Brushes Set of 3



- The synthetic sable (also called sable substitute) brushes are suitable for water-colour, oil and acrylic paints.
- They combine a traditional spring with a fine flexible point and are used for a variety of painting techniques, including glass, silk, and pottery painting.
- Set of 3 contains one each of ¼", ½" and ¾" brushes.

CODE	Description	Unit	4+	1+
SBR003SET	Flat Synthetic Set	3 Piece	3.50	3.80

## One Stroke Wash Brush 1½"



- Superior quality synthetic Wash Brushes.
- Used for painting, blending and smoothing.
- Ideal for painting backgrounds.
- Soft, flat bristles ensure that no bristle marks appear.
- Brush width 1.5" (38mm).

CODE	Description	Unit	4+	1+
BRU112WSH	One Stroke Wash Brush 1½"	1	2.30	2.50

## Black Paste Brush Pack of 10



- A ¼" flat tip black hog bristle paste brush.
- Approximate overall length 175mm.
- Ideal for use with paste and glue.

CODE	Description	Unit	4+	1+
DBR140P10	Black Paste Brush ¼" Pack of 10		2.90	3.20

## Daler Rowney Table Easel



- Daler Rowney's Table Easel is a simple and practical bench mounted design.
- Wooden table easel with adjustable support.
- Takes canvas up to 560mm (22in) in height.

CODE	Description	Unit	3+	1+
ESL010TBL	Table	1	20.25	22.00

## Daler Rowney Exeter Radial Easel



- Daler Rowney's Exeter Easel is the popular 'H' frame Radial studio design.
- Precision-made beechwood, fully adjustable to numerous positions.
- Extra large locking wing nut and easily foldable.
- Maximum canvas height: 1880mm.
- Folded size: 1560x190x190mm.
- Weight: 7.25kg.

CODE	Description	Unit	3+	1+
ESL003EXR	Exeter	1	84.50	90.00

## Daler Rowney Lyra Easel



- Daler Rowney's Lyra Easel is a traditional wooden 'A' frame design.
- High side-poles and adjustable bottom canvas holder.
- Maximum canvas height: 1250mm.
- Weight: 7kg.

CODE	Description	Unit	3+	1+
ESL728LYR	Lyra	1	56.25	62.00

## Aluminium Folding Table Easel



- Convenient folding table easel, competitively priced, ideal for class groups.
- Made of aluminium with a fixed hind leg.
- Folds flat - 500mm length when closed.

CODE	Description	Unit	10+	4+	1+
FTE500ALU	Folding Easel	1	8.25	8.50	9.00

## Single Inking Tray



- A simple 25cm x 20cm light and sturdy inking tray for ink rollers and sponge rollers.
- Also ideal for mixing paint.

CODE	Description	Unit	4+	1+
TRA252WHT	Single Inking Tray	1	1.95	2.10

## 6 Well Economy Palette



- A 23cm x 15cm flexible, competitively priced paint palette.
- Palettes stack for storage and include 2 stacking-holes.

CODE	Description	Unit	4+	1+
PPL600WHT	6 Well Economy Palette	1	0.85	0.90

### Plastic Palette Knives Pack of 4



- A selection of white plastic palette knives available in 4 shapes.
- Suitable for spreading paint, paste and glue, and also for light scraping.
- Durable yet flexible plastic.
- Approximate length 19cm.
- See enlarged photo for individual product codes.

CODE	Description	Unit	4+	1+
PPK400PLS	Plastic Palette Knives	Pack of 4	1.70	1.90

### Plastic Tablecloth



- Durable plastic splash mat printed with an art and craft design.
- Protects tables and floors from spillages and stains.

152 x 152cm

CODE	Description	Unit	4+	1+
PTM150PLS	1.5 x 1.5m	1	4.10	4.50

### Wax Melting Pot



- 230V electric wax melting pot with 0.3 litre capacity. Features an aluminium melting cup with non-drip rim, and graded temperature control in a sturdy plastic casing.
- Maximum temperature 135°C with overheat protection.
- Height 100mm, diameter 200mm.
- Safety tested and CE marked.
- 230V AC / 50Hz / 300W.

CODE	Description	Unit	1+
WMP003ELC	Wax Melting Pot 230V/300W	1	129.95

### Steel Palette Knives Pack of 5



- A set of 5 stainless steel palette knives suitable for painting and scraping.
- Spring steel provides flexibility and elastic durability.
- Approximate length 20cm - 22cm.

CODE	Description	Unit	4+	1+
SPK500STL	Steel Palette Knives	Pack of 5	8.95	9.75

### Protective Craft Mats Set 5 Piece

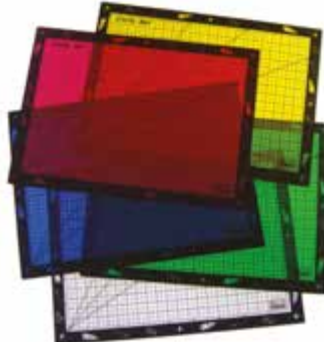

- Set of 5 assorted colour easy-to-clean translucent polypropylene mats for protecting work surfaces from stains and spills.
- Hard-wearing and flexible.
- Dimensions 50 x 36cm, thickness 0.5mm.

CODE	Description	Unit	4+	1+
PCM500SET	Protective Craft Mats Set	5 Piece	8.95	9.75

### Tjanting Tool



- A traditional tjanting tool used to apply wax to fabric for batik work.
- The bowl has a 35mm diameter, with a 1.0mm diameter spout.
- The brass bowl and spout help retain the heat and keep the wax flowing.
- Overall length approximately 240mm.
- See also the batik frames.

CODE	Size	Unit	4+	1+
TJT351BRS	Tjanting Tool 35mm/1mm Spout	1	7.75	8.50

### Standard Water Pot Pack of 10



- Set of 10 translucent water pots with lids and stoppers.
- Approximate height 8cm, diameter 7cm.

CODE	Description	Unit	4+	1+
WPT010SET	Standard Water Pot	Pack of 10	7.25	7.95

### Pastel Fixative 400ml



- Fixative spray, ideal for protecting all pastel, charcoal or pencil drawings.
- Acid free spray application.
- 400ml aerosol.

CODE	Description	Unit	4+	1+
PFT400SPY	400ml	1	7.25	7.75

### Paraffin Wax Pellets



- Paraffin wax in pellet form - easy to measure, pour and melt.
- Melting point approximately 54°C.
- Supplied in bags of 2kg.

CODE	Description	Unit	4+	1+
PFW200PEL	Paraffin Wax Pellets 2kg	1	14.95	16.25

## Air Hardening Clay



- Enjoy the experience of using clay with no need for the expense or safety issues of a kiln.
- A natural product, mined locally in Staffordshire, the home of the Potteries and Shropshire.
- Added Nylon fibres to give extra strength to the finished model.
- Finished models can be decorated with almost any paint and given a coat of PVA or varnish to give a glossy finish.
- Wheat and Gluten Free.

CODE	Description	Unit	12+	6+	1+
CLY125ARRH	12.5kg	1	9.50	10.00	11.25

## Wax and Clay Modeller's Kit 12 Piece



- 12 piece set of double ended sculpting tools for working soft, pliable materials.
- Stainless tools measure 6" long, different tips for a variety of carving, shaping, detailing tasks.

CODE	Description	Unit	4+	1+
WCM012SET	Modeller's Kit	12 Piece	11.25	13.00

## Plastic Clay Knives Pack of 14



- Set of 14 differently shaped double-ended plastic tools.
- Ideal for cutting and forming clay and plasticine.
- Durable plastic, approximate length 14cm.

CODE	Description	Unit	4+	1+
PCK140PLS	Plastic Clay Knives	Pack of 14	1.90	2.10

## Boxwood Tools Set of 10



- Set of 10 double-ended durable boxwood clay tools.
- Ideal for cutting and forming clay and plasticine.
- Approximate length 16cm.

CODE	Description	Unit	4+	1+
BCT010SET	Boxwood Tools Set	1	6.50	6.95

## Pottery Tool Set 8 Piece



- Inexpensive set of modelling tools for use with clay.
- Set contains: sponge, cutting wire, metal scraper, metal needle tool, loop tool, boxwood modelling tool, ribbon cutter tool and boxwood potter's rib.

CODE	Description	Unit	4+	1+
PTS800SET	Pottery Tool Set	8 Piece	4.95	5.50

## Blue Rubber Finishing Tool



- Flexible rubber kidney with approximate dimensions 105mm x 53mm.
- One flat surface and one convex surface.
- Ideal for gently smoothing and compressing clay without distorting the overall form.

CODE	Description	Unit	4+	1+
RFT105KYD	Blue Rubber Finishing Tool	1	1.70	1.85

## Large Smooth Wooden Rolling Pin



- Smooth wooden surface ideal for work on a variety of materials.
- Approximate overall length 42cm, diameter 4cm.

CODE	Description	Unit	4+	1+
RPN430WDN	Lge Smth Wooden Rolling Pin	1	4.95	5.50

## Banding Wheel



- Economical introduction to clay spinning.
- Diameter 200mm, height 115mm.
- Grooves for easy centering.
- Ball bearing ensures smooth and precise rotation.
- Heavy (2.2kg) construction ensures stability in use.

CODE	Description	Unit	2+	1+
BGW200MTL	Banding Wheel	1	48.95	52.95

## Discus Pottery Wheel



- Award winning high quality UK made potter's wheel with a five year guarantee.
- Powerful 300W electronically controlled 1/8hp electric motor which delivers a constant full torque at all speeds - easily copes with up to 12kg of clay.
- Fully portable unit, having a high impact ABS bowl, with non-slip feet. Standing 160mm above the work surface - very easy to stack and store (bowl and wheel 6.5kg).
- The Potter's Wheel includes the Foot Pedal and the Controller. This contains a transformer so the motor is run at low voltage for safety.
- Cast 250mm heavyweight aluminium wheel head with the Discus bat retaining system.
- Supplied with a set of bats in 3 sizes (254, 280 and 305mm).

CODE	Description	Unit	2+	1+
PTE300DSC	Discus	1	925.00	945.00

### Uhlig Enamelling Kiln U5



- The most popular compact model - simple to operate.
- Max temp 950°C - for enamelling you need a working temperature of 700 - 820°C.
- Chamber size 120mm x 130mm x 70mm.
- Reaches 800°C in 30 minutes.
- Weight 5.5 kg, 950W, 13 amp.

CODE	Description	Unit	1+
UHG005KLN	U5	1	<b>350.00</b>

### Uhlig Enamelling Kiln U15



- Popular larger model – simple to operate.
- Max temp 1000°C.
- Chamber size 130mm x 130mm x 75mm.
- Reaches 800°C in 30 minutes.
- Weight 6 kg, 950W, 13 amp.

CODE	Description	Unit	1+
UHG015KLN	U15	1	<b>299.00</b>

### Efco Enamelling Kiln 135 KF



- An enamelling kiln complete with door switch, which cuts the power to the heating element when the door is opened as an extra safety measure.
- Spy hole to view inside the kiln.
- Chamber size 155mm x 140mm x 90mm.
- Reaches 800°C in 30 minutes.
- Must be operated with a temperature control device.

CODE	Description	Unit	1+
EFC135KLN	135 KF	1	<b>475.00</b>

### Efco Enamelling Kiln 180 KF



- An enamelling kiln complete with door switch, which cuts the power to the heating element when the door is opened as an extra safety measure.
- Spy hole to view inside the kiln.
- Chamber size 225mm x 190mm x 115mm.
- Reaches 800°C in 30 minutes.
- Must be operated with a temperature control device.

CODE	Description	Unit	1+
EFC180KLN	180 KF	1	<b>975.00</b>

### Efco Temperature Controller Basic



- Ideal for those enamellers working over long periods or teaching enamelling in schools.
- The in-line plug will be an European style, so retain this from the kiln and add the UK 3-pn adaptor to the lead.
- For switching kilns up to 3500W (output), 230 Volts.

CODE	Description	Unit	1+
EFC001TCR	Basic	1	<b>159.95</b>

### Efco Temperature Controller TRP008 Digital



- An automatic on and off controlling device with a digital display for actual and set values.
- The in-line plug will be an European style, so retain this from the kiln and add the UK 3-pn adaptor to the lead.
- Supplied with a NiCr-Ni thermocouple in accordance with DIN 43710 serves as a sensor.
- For switching kilns up to 3500W (output), 230 Volts.

CODE	Description	Unit	1+
EFC008TCR	TRP008	1	<b>660.00</b>

### Spraycraft Airbrush and Compressor Kit



- A single action gravity feed airbrush with a 0.4mm needle/nozzle
- Supplied with a mini compressor - exceptionally quiet, having 3 pressure settings up to a maximum of 15psi.
- From 1.6mm to 30mm spray pattern.

Includes:

- SP30 Gravity Feed Airbrush.
- Mini Compressor (Mains).
- Hose.
- Instructions.

CODE	Description	Unit	4+	1+
SPY300SET	Airbrush & Compressor Kit	1	<b>84.50</b>	89.50

### Spraycraft Primary Colour Set 6 Liquid Acrylic Colours



- Includes red, white, blue, yellow, green, black. 6 x 32ml.
- For metals, glass, paper, canvas, wood, leather, fabrics, ceramics and clay.
- Can be mixed for layering and glazing on large surfaces and painting miniatures.

CODE	Description	Unit	1+
SPY632PCP	Liquid Acrylic Set	6 Piece	<b>29.25</b>

### Clay Storage Container



- Manufactured from single skin glass reinforced plastic.
- Heavy duty hinges and painted grey.
- 168 litre capacity.

**L 990mm x W 540mm x H 840mm**

CODE	Description	Unit	1+
CLY168STC	168 Litre	1	<b>394.95</b>

## Block Printing Ink Single



- A highly pigmented opaque watercolour.
- All colours are inter-mixable and light fast.
- Use with woodcut blocks, lino and quick print.
- Non-toxic, safe for children. Wheat, gluten and dairy free

300ml

CODE	Description	Unit	2+	1+
BPR320LEM	Lemon	1	3.00	3.25
BPR321BYL	Brilliant Yellow	1	3.00	3.25
BPR322ORG	Orange	1	3.00	3.25
BPR324BRD	Brilliant Red	1	3.00	3.25
BPR325CRM	Crimson	1	3.00	3.25
BPR327PUR	Purple	1	3.00	3.25
BPR329BBU	Brilliant Blue	1	3.00	3.25
BPR333TUR	Turquoise	1	3.00	3.25
BPR336BGR	Brilliant Green	1	3.00	3.25
BPR338BLK	Black	1	3.00	3.25
BPR340BSN	Burnt Sienna	1	3.00	3.25
BPR343WHT	White	1	3.00	3.25

## Safety Hand Guard



- An ergonomically designed guard for both left and right hand users.
- Any slippage is caught in the upright walls.

CODE	Description	Unit	1+
LPR100SHG	Safety HandGuard	1	1.95

## Bench Hook Holder



- Sturdy MDF construction with approximate dimensions 30cm x 20cm (12" x 8").
- Simply hooks on to desk or bench edge.
- Lino block is held firmly in upper corner for safe cutting.

CODE	Description	Unit	4+	1+
BHK320LNC	Bench Hook 20 x 30cm	1	5.75	6.25

## Lino Cutter Set 5 Piece



- This quality set includes a handle and 5 assorted high carbon steel blades.
- Durable polypropylene handle with an aluminium clamping ferrule.
- Made in the UK.

CODE	Description	Unit	1+
LPR501SET	Cutter Set	5 Piece	4.30

## Lino Cutter and Baren Kit 5 Piece



- This versatile set includes 5 assorted cutters, handle and Baren.
- The Baren which is a burnishing tool doubles as a storage unit for the cutters.
- Additionally can be used for stamping..

CODE	Description	Unit	1+
LPR535SET	Cutter/Baren Kit	5 Piece	5.50

## Safety Lino Cutters Pack Assorted Pack of 12



- Precision ground safety lino cutters with recessed cutting edge.
- Ideal for less experienced users.
- The safety wings also prevent the cutter from carving too deeply.
- Made in the UK.

CODE	Description	Unit	1+
LPR012SLC	Assorted Cutters	Pack of 12	4.75

## Premium Ink Roller



- Sturdy UK made premium ink roller with a rigid body and steel roller frame.
- Fully machine ground concentric rubber roller.
- Self-lubricating nylon bearings.
- Can be used with water or oil based inks.

CODE	Description	Unit	1+
LPR100RLR	100mm	1	6.50

## Lino Cutters with Handle Pack of 5



- A selection of 5 cutter blades, all with different profiles, supplied with a plastic handle.
- Cutter length 40mm, handle length 87mm.

CODE	Description	Unit	4+	1+
LNC500SET	Lino Cutters with Handle	Pack of 5	2.50	2.70

## Lino Brayer Rollers



- Hard rubber rollers with a sturdy plastic handle.
- Handle includes a back rest to hold roller away from working surface when turned upside down.
- Rollers available in several lengths, all with diameter approx 30mm.
- Handle length 135mm.

CODE	Description	Unit	4+	1+
LPR060RLR	Lino Brayer Roller 60mm	1	3.60	3.90
LPR102RLR	Lino Brayer Roller 102mm	1	4.40	4.80
LPR152RLR	Lino Brayer Roller 152mm	1	4.80	5.25



### Lino Printing Blocks Pack of 10



- A biodegradable lino made from linseed oil and wood flour.
- Especially made soft for easy carving.
- Supplied in packs of the popular sizes.

CODE	Description	Unit	4+	1+
LPR152LPB	152 x 101mm	Pack of 10	<b>7.95</b>	
LPR203LPB	203 x 152mm	Pack of 10	<b>15.50</b>	
LPR305LPB	205 x 203mm	Pack of 10	<b>29.95</b>	

### Polymer Block Pack of 10

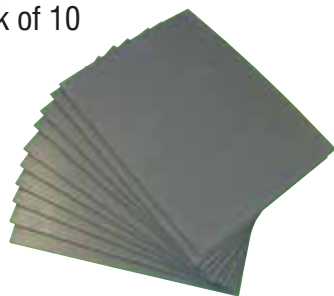

- New softer double sided polymer blocks.
- Easier and safer to carve than traditional lino blocks.
- Polymer does not crumble, and sharp lines can be cut for high definition prints.
- Blocks will not distort under printing pressure.
- Available in a variety of sizes, all approximately 3.2mm in thickness.

CODE	Description	Unit	4+	1+
PBL150PAK	Polymer Block 15x10cm	Pack of 10	<b>8.50</b>	9.25
PBL200PAK	Polymer Block 20x15cm	Pack of 10	<b>15.50</b>	16.95

### Safeprint Pack of 25



- A safe alternative to printing with polymer blocks.
- Impressions can be made in the foam using blunt objects, though sharp tools may be used if necessary.
- Ideal for use as an introduction to block printing.
- These foam sheets are also commonly used for model making, being easily cut with a craft knife or scissors.
- Pack of 25 A4 sheets, each 3mm thick.

CODE	Description	Unit	4+	1+
SPR025PAK	Safeprint A4 Size	Pack of 25	<b>12.95</b>	13.95

### Greyboard 2mm Sheet Pack of 10



- Rigid board with a smooth, flat finish - for sculpture, modelling, mounting art prints and creating displays.
- Produced from 100% post-consumer waste, is FSC certified and meets all the EU REACH regulations required.
- Supplied in 2mm thickness.

#### Size 640 x 900 x 2mm

CODE	Description	Unit	4+	1+
GYB902PAK	Greyboard	Pack of 10	<b>15.25</b>	15.95

### FoamWerks Hole Drill



- Drill perfect holes in foamboard using one of three interchangeable quick-change drill tips included.
- Choose 3/4", 1/2" and 0.28" diameters.
- The Hole Drill WD-8011 works with 3/16" foamboard.

CODE	Description	Unit	1+
LGN801HDR	Hole Drill	1	<b>24.75</b>

### FoamWerks Circle Cutter



- Cut perfect circles from 1" to 6" diameters.
- Center depth indicator shows blade progression for board depths from 1/8" to 1/2".
- Features dual inch/metric rail, centering pin, magnetic blade slot and clear acrylic safety dome.
- The circle cutter includes five blades.

CODE	Description	Unit	1+
LGN800CCR	Circle Cutter	1	<b>50.50</b>
LGN805BLD	Spare Blades	Pack of 5	<b>3.00</b>

### Aluminium Mesh



- Aluminium mesh with holes approximately 1mm x 2mm.
- Easy to cut, form and contour, but rigid enough to retain its form once shaped.
- Ideal for use with many modelling materials, but particularly suitable for use with papier-mache and plaster bandages.
- Supplied as a roll with dimensions 3m x 0.5m.

CODE	Description	Unit	4+	1+
ALM305FIN	Al. Mesh Fine 0.5m x 3m	1	<b>13.50</b>	14.75

### Aluminium Modelling Rod

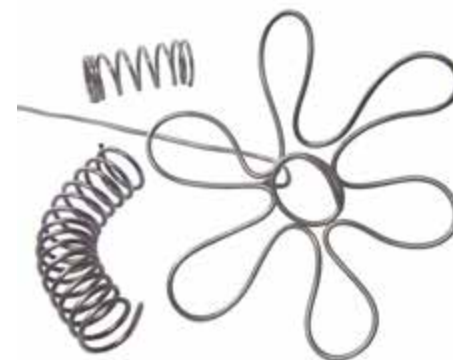

- Aluminium wire rods are soft, malleable and easy to cut.
- They bend easily, yet are rigid enough to retain their shape.
- Ideal for strengthening models, but can also be used as a design medium in its own right.
- The rods are 3.2mm in diameter and 10m in length.

CODE	Description	Unit	4+	1+
ALU103ROD	Al. Rod 3.2mm x 10m	1	<b>5.25</b>	5.75

### Steel Modeling Wire



- Mild steel wire ideal for modelling and construction work.
- Galvanised to resist corrosion - suitable for use outdoors.
- Diameter 1.0mm. Supplied in 500g coils.
- Approximate length 80m.

CODE	Description	Unit	4+	1+
SMW501STL	Steel Wire dia 1mm 500g coil	1	<b>4.20</b>	4.60

## Wire Netting



- Galvanised wire mesh, ideal for large scale models.
- Mesh width (hole size) 25mm x 40mm.
- Wire diameter 0.7mm.
- Roll measures 900mm x 10m.

CODE	Description	Unit	4+	1+
WRN910GLV	Wire Netting	1	<b>27.50</b>	29.75

## Florist Wire



- Mild steel wire for modelling and construction.
- Galvanised to resist corrosion - suitable for use outdoors.
- Wire diameter 0.9mm.
- Approximate quantity of 1400 x 300mm lengths - 2.5kg bundle

CODE	Description	Unit	4+	1+
FLW0256LV	Florist Wire	1	<b>12.25</b>	13.25

## Knitting Wire



- Mild steel wire for knitting, textile work and jewellery.
- Thin yet very strong.
- Approximate weight 1.5kg.
- 0.44mm x 1300m ree.

CODE	Description	Unit	5+	1+
KNW015STL	Knitting Wire	1	<b>17.25</b>	18.95

## Poly Carry Case

A2, A3 or A4



- A cost effective solution to safeguard artwork.
- Click lock handle.
- Available in 3 sizes - A4+ (210 x 297mm), A3 (297 x 420mm) and A2 (420 x 594mm).

CODE	Description	Unit	12+	1+
PFC400PLY	A4+	1	<b>2.70</b>	2.95
PFC300PLY	A3	1	<b>3.20</b>	3.50
PFC200PLY	A2	1	<b>5.25</b>	5.75

## Professional Portfolio Case

A2, A3 or A4



- Professional portfolio case with zip.
- Robust carrying handle.
- Available in 3 sizes - A4, A3 and A2.

CODE	Description	Unit	6+	1+
PFC400PRF	A4	1	<b>13.25</b>	14.50
PFC300PRF	A3	1	<b>15.25</b>	16.75
PFC200PRF	A2	1	<b>25.50</b>	27.95

## Artist's Caddy Box



- Ideal for storage of art, graphic and stationery materials.
- Two cantilever trays for small parts.

310 x 190 x 145mm

CODE	Description	Unit	4+	1+
TBX310CAD	Caddy Box	1	<b>9.95</b>	10.50

## Wooden Male Manikin



- 12" (30cm) tall wooden male manikin.
- Accurately proportioned and smoothly finished.
- All joints move in a life-like manner to assume most human poses.
- An ideal tool to help learn figure drawing.

CODE	Description	Unit	4+	1+
MNK120WDN	Wooden Male Manikin 12"	1	<b>5.50</b>	5.95

SEE STORAGE PAGE 298

## Small Compartment Boxes



SEE MATERIALS PAGE 21

## Foam Board



### White Artstraws

Pack of 1800 or 900



- Artstraws can be cut, curled, coloured, stuck, threaded, plaited and woven.
- Create cards, collages, masks, geometric shapes, flowers, jewellery and 3D models.
- Particularly useful for art and craft and Design Technology and also applicable across the curriculum.
- Ideal for teaching basic mathematical concepts and exploring structure and movement.
- Unwaxed paper straws, 415mm long.

CODE	Description	Unit	6+	1+
ASW184WHT	White 4mm	Pack of 1800	19.25	20.50
ASW906WHT	White 6mm	Pack of 900	17.50	18.75

### Coloured Artstraws

Assorted Packs of 1800 or 900



- Artstraws can be cut, curled, stuck, threaded, plaited and woven.
- Create cards, collages, masks, geometric shapes, flowers, jewellery and 3D models.
- Particularly useful for art and craft and Design Technology and also applicable across the curriculum.
- Ideal for teaching basic mathematical concepts and exploring structure and movement.
- Unwaxed paper straws, 415mm long.

CODE	Description	Unit	6+	1+
ASW184ASS	Coloured 4mm	Pack of 1800	21.95	23.50
ASW906ASS	Coloured 6mm	Pack of 900	20.50	21.95

### Pipe Cleaners

Assorted Packs of 100 or 50



- A popular value pack of fluffy, soft and bendable pipe cleaners.
- Assorted colours.
- Available in standard (150 x 4mm), Jumbo (300 x 6mm) and giant (500 x 12mm).

CODE	Description	Unit	6+	1+
PPC154ASS	150mm x 4mm	Pack of 100	1.55	1.75
PPC304ASS	300mm x 6mm	Pack of 100	2.30	2.50
PPC512ASS	500mm x 12mm	Pack of 50	2.95	3.30

### Casting Powder



- Suitable for casting and moulding.
- Quick and easy to use.
- Mixing instructions on the bag.
- Finished pieces can be painted or varnished.

CODE	Description	Unit	1+
CPD300CST	Casting Powder 3kg	1	4.00

### 3D Roc Pack of 4



- Cotton gauze medical bandages impregnated with Plaster of Paris.
- Ideal for the construction of 3D models by application to an inflexible frame.
- Ideal for use with some of our metal modelling items.
- Setting time 2-5 minutes.
- Pack of 4 rolls, each 2.75m x 15cm.

CODE	Description	Unit	4+	1+
POP154PAK	POP Roc 150mm x 2.75m	Pack of 4	4.80	5.25

### Liquid Latex

1 or 5 Litres



- High quality latex for making rubber moulds.
- Used in the simple production of moulds for short runs.
- Available in either 1 litre or 5 litre sizes.

CODE	Description	Unit	4+	1+
LLX001STD	1 litre	1	10.25	10.95
LLX005LRG	5 litre	1	46.95	49.95

### Washable Glue Blue Label



- The most widely used type of glue in pre-school.
- Use to stick paper and card.
- Washable when wet and dry.
- Dries to a clear finish.
- Phatlate, Wheat and Gluten free.

CODE	Size	Unit	4+	1+
WGL100BLU	1 Litre	1	1.75	2.00
WGL500BLU	5 Litres	1	6.75	7.25

### Plastic Spatulas

Pack of 10



- White plastic spatulas / paste spreaders, ideal for glue, paste and paint.
- Flexible tip, approximate length 11cm.

CODE	Description	Unit	4+	1+
SPA010PLS	Plastic Spatulas	Pack of 10	1.10	1.20

SEE CONSUMABLES PAGE 58

### Glue Guns & Glue Sticks



## Coloured Re-Useable Clay Assorted Colours



- This tremendously versatile modelling material is a direct comparison to the original Plasticine product and equivalent in quality.
- Can be reused repeatedly, and will not dry out.
- Malleable but models will always retain their shape.
- Use for moulds to produce plaster casts.
- Wheat and Gluten free.

500g

CODE	Description	Unit	2+	1+
RUC503PNK	Pink	1	1.65	1.80
RUC521YEL	Yellow	1	1.65	1.80
RUC522ORG	Orange	1	1.65	1.80
RUC524RED	Red	1	1.65	1.80
RUC527PUR	Purple	1	1.65	1.80
RUC529DBU	Dark Blue	1	1.65	1.80
RUC533TUR	Turquoise	1	1.65	1.80
RUC536DGR	Dark Green	1	1.65	1.80
RUC537LGR	Green	1	1.65	1.80
RUC539BRN	Brown	1	1.65	1.80
RUC540TRC	Terracotta	1	1.65	1.80
RUC543WHT	White	1	1.65	1.80

## Coloured Re-Useable Clay Rainbow



500g

CODE	Description	Unit	2+	1+
RUC500RBW	Rainbow	1	1.80	1.95

## Coloured Re-Useable Clay Neon



500g

CODE	Description	Unit	2+	1+
RUC500NEN	Neon	1	1.80	1.95

## Coloured Re-Useable Clay People Colours



500g

CODE	Description	Unit	2+	1+
RUC500PPL	People Colours	1	1.80	1.95

## Headless Matchsticks Natural Pack of 1000



- Versatile economical modelling material.

CODE	Description	Unit	4+	1+
MST001KHL	Headless Matchsticks	Pack of 1000	1.45	1.60

## Coloured Headless Matchsticks Pack of 1000



- Versatile economical modelling material.

CODE	Description	Unit	4+	1+
MST101KCL	Headless Matchsticks	Pack of 1000	1.45	1.60

## Natural Lollipop Sticks Small Pack of 1000 Large Pack of 100



- Plain lollipop sticks available in 2 sizes.
- They can be painted and glued and are ideal for many model making projects.
- Standard lollipop sticks are approximately 115 x 10mm, and the large lollipop sticks are approximately 150 x 18mm.

CODE	Description	Unit	4+	1+
LST115PLN	Small Natural	Pack of 1000	7.75	8.50
LST100LPL	Large Natural	Pack of 100	1.95	2.20

## Coloured Lollipop Sticks Assorted Pack of 1000 or 100



- Assorted colour lollipop sticks available in 2 sizes.
- They can be painted and glued and are ideal for many model making projects.
- Standard lollipop sticks are approximately 115 x 10mm, and the large lollipop sticks are approximately 150 x 18mm.

CODE	Description	Unit	4+	1+
LST115CLR	Small Coloured	Pack of 1000	9.50	10.25
LST100LCR	Large Coloured	Pack of 100	2.20	2.40

## Modelling Sticks Pack of 100



- Long square timber stick, useful addition on small scale projects.

150 x 4 x 5mm

CODE	Description	Unit	4+	1+
MST150PLN	Modelling Sticks	Pack of 100	7.75	8.50

## LED Flickering Tealight Pack 12



- Set of 12 battery operated tea lights.
- Light flickers to imitate a real candle.
- CR2032 battery supplied lasts for 40-60 hours.
- Diameter 38mm, overall height 38mm.
- Will fit in a standard tea light holder.

CODE	Description	Unit	4+	1+
FTL120LED	LED Flickering Tealight	Pack of 12	7.25	7.95

### Wall Mounted Drying Rack 20 Shelves



- Wall Mounted drying-racks designed to be mounted directly onto the wall.
- Shelves can be folded up to save space.
- Suitable for A3 size paper.

50.5 x 61.5 x 41cm

CODE	Description	Unit	1+
DYR020WMT	Wall/20	1	103.50

### Table Top Drying Rack 20 Shelves



- Double sided dryer which is easy to move around the classroom.
- Removable shelves if extra space is required.
- Suitable for A3 size paper.

20 Shelves: 36 x 75 x 50cm

CODE	Description	Unit	1+
DYR020TTP	Table/20	1	96.50

### Table Top Drying Rack 40 Shelves



- Double sided dryer which is easy to move around the classroom.
- Removable shelves if extra space is required.
- Suitable for A3 size paper.

40 Shelves: 65 x 75 x 50cm

CODE	Description	Unit	1+
DYR040TTP	Table/40	1	151.50

### Spring Loaded Drying Rack 10 Shelves



- Paint drying rack made from top quality steel and features spring loaded racks and separator bars.
- Suitable for A2 paper.

61 x 53 x 52cm

CODE	Description	Unit	1+
DYR010SPR	Spring/10	1	146.95

### Spring Loaded Drying Rack 20 Shelves



- Paint drying rack made from top quality steel and features spring loaded racks and separator bars.
- Suitable for A2 paper.
- Comes with wheels for easy manoeuvring.

61 x 74.5 x 52cm

CODE	Description	Unit	1+
DYR020SPR	Spring/20	1	203.50

### Mobile Drying Rack 30 Shelves



- Sturdy metal trolley supplied with 30 wire drying shelves.
- Trolley includes 2 castors and for mobility.
- Up to A3 paper.

103 x 65 x 55cm

CODE	Description	Unit	1+
DYR030MBL	Mobile/30	1	186.95

### Large Mobile Drying Rack 40 Shelves



- Double sided mobile drying rack with 4 castors (2 lockable).
- 40 wire shelves that are plastic coated for easy cleaning.
- Wide shelves take up to A2 paper.

108 x 50.5 x 82cm

CODE	Description	Unit	1+
DYR040MBL	Mobile/40	1	215.75

### Spraying Table



- Galvanised steel construction.
- Table size 1000 x 500mm.
- Height adjusts from 800mm to 1100mm.

CODE	Description	Unit	1+
SPT150GAL	Spraying Table	1	159.95

### Drying Rack



- Steel construction with multiple arms for storing products whilst drying after spraying.
- Can be made up in either format as shown above.
- Bars are 500mm long with 85mm spacing.
- Overall height 1665mm.
- Adjustable ring frame gives 290mm and 600mm centres.

CODE	Description	Unit	1+
DRK500BAR	Drying Rack	1	365.00

# Textiles and Haberdashery

---

**Sewing Machines**  
271

---

**Haberdashery**  
271-272

---

**Textiles**  
272



## Janome Sewing Machine



- Ideal for educational establishments as the metal body provides the robustness and the design makes it so easy to use.
- Choose your stitch and the information window will advise on stitch width and length settings and the correct foot to use.
- Mechanical Sewing Machine.
- 22 built in stitches plus an automatic one-step buttonhole.
- Free Arm / Flat Bed Conversion.
- Horizontal Type Spool Pin.
- Superior Feed System (SFS) / 7 Piece Feed Dog.
- Snap on Feet.
- Manual Tension Control.
- Drop Feed.
- Twin Needle Facility.
- Horizontal Full Rotary Hook.
- Maximum Stitch Length: 4mm, maximum stitch width: 6.5mm.
- Machine Size: W390 x D180 x H290mm.
- Maximum Sewing Speed: 900 s.p.m. (appx.).
- Power Switch.
- Approximate Weight: 10kg and has a carry handle.

CODE	Description	Unit	3+	1+
JAN220SWM	Janome Sewing Machine	1	299.00	325.00

## Silver CH01 Sewing/Embroidery Machine



- The CH01 has 100 built in embroidery designs, 120 frame patterns and 6 different font styles.
- Full touch screen capability, meaning selection of features is quick and easy.
- USB feature on the machine allows you to download embroidery designs online\* and use them on the machine, giving you a larger choice of designs.
- Also as a sewing machine with 88 stitches (Utility and Decorative), 8 x 1-step button holes and 3 different style fonts (Upper and Lower case).

CODE	Description	Unit	1+
SVR001EMB	H43BX	1	575.00

## Silver 301 Sewing Machine



- Features 9 stitch functions and 4 step buttonhole.
- Front loaded bobbin and a horizontal spool pin.
- Manual tension adjustment and auto needle threader and LED light.
- Accessory box including 4 x feet (All Purpose, Zipper, Buttonhole, Button Sew), Darning Plate, Needles, Bobbins, oil etc.
- Adjustable stitch length 0-4.0mm and width 0-5.0mm.

CODE	Description	Unit	4+	1+
SVR301SEW	301	1	95.00	99.50

## Silver 303 Sewing Machine



- This anniversary machine offers an advanced introductory machine at a very competitive price.
- Front loaded bobbin and a horizontal spool pin.
- Manual tension adjustment and auto needle threader and LED light.
- Accessory box including 4 x feet (All Purpose, Zipper, Buttonhole, Button Sew), Darning Plate, Needles, Bobbins, oil etc..
- Adjustable stitch length 0-4.0mm and width 0-5.0mm.

CODE	Description	Unit	4+	1+
SVR303SEW	303	1	125.00	129.50

## Craft Buttons Assorted 500g Pack



- Assorted buttons in different colourways.

CODE	Description	Unit	4+	1+
BUT500ASS	Assorted 500g Pack	1	6.25	6.75

## Safety Pins 36mm Pack of 50



- Nickel plated.
- 36mm length.

CODE	Description	Unit	4+	1+
SPN050PAK	36mm Pack of 50		1.25	1.40

## Seam Ripper (Small) Pack of 25 or 100



- Seam rippers can be used for many sewing and general purpose uses, including quick un-picking of stitching and for cutting open button holes neatly.
- With safety ball and cover.

CODE	Description	Unit	2+	1+
SRP025SML	25	Pack of 25	7.95	8.95
SRP100SML	100	Pack of 100	29.95	

## Pinking Shears



- Heavy duty, high quality pinking blade shears for an accurate trimming cut in dressmaking.
- Also to produce decorative effects in art and craft designs.
- Black comfort grip handles with quality steel blades.
- Blade length 8"/210mm.

CODE	Description	Unit	12+	4+	1+
SCS820PNK	Pinking	1	9.50	9.95	10.95

## Polyester Wadding

4oz



- Quiltable and washable polyester wadding 4oz.
- For use in cushions, pillows and upholstery.
- 1m x 2m.

CODE	Description	Unit	4+	1+
WAD412PYR	4oz	1	4.75	5.25

## Tape Measure for Textiles



- Flexible tape for use in textiles.
- Imperial measurements on one side and metric on the other.
- 150cm/60".

CODE	Description	Unit	12+	6+	1+
TPM150FAB	150cm/60"	1	0.40	0.45	0.50

## Polyester Thread



- Ideal thread for all sewing projects by machine and hand.
- Available in black or white.
- 100m.

CODE	Description	Unit	36+	12+	1+
THP100BLK	Black	1	0.75	0.85	0.95
THP100WHT	White	1	0.75	0.85	0.95

## Premium Felt Squares

Pack of 50



- An assorted pack of felt squares.
- 22cm/9" square.

CODE	Description	Unit	4+	1+
FLT950ASS	Assorted	Pack	14.75	15.50

## Mixed Needles

Pack of 50



- A comprehensive selection of Sharps, Embroidery, Ball Point and more.
- Contains 50 of all the household essentials.

CODE	Description	Unit	5+	1+
NED050MIX	Mixed	Pack	1.95	2.50

## Iron-on Interfacing

Medium



- Medium grade iron-on.
- White colour.
- 90cm x 50cm.

CODE	Description	Unit	4+	1+
IFC950MED	Medium	1	1.95	2.50

## Cotton Fat Quarter Bundle Brights

Pack of 5



- Cotton fat quarters in a mix of bright colours.
- Can be used together or mixed with other packs in a variety of quilting projects.
- 100% cotton. Wash at 40 degrees.
- Each quarter measures 54cm x 45cm.

CODE	Description	Unit	2+	1+
CFQ500BGT	Bright	Pack of 5	4.95	5.50

## Plastic Headed Pins

Pack of 40



- Steel pins with plastic heads in assorted colours.

CODE	Description	Unit	4+	1+
NED050MIX	Mixed	Pack of 40	0.95	1.25

## Acrylic Yarn Mixed Pack

Pack of 10 x 100g



- Assorted double knit yarn for weaving, threading, primary sewing, knitting etc.
- Pack of 10 x assorted bright colours (including black and white).
- 100g ball of each colour.

CODE	Description	Unit	4+	1+
ACY110MIX	Std Mix	Pack of 10	14.95	15.95





# Graphics

---

**Trimmers**  
274

---

**Drawing Equipment**  
275-277

---

**Pens & Pencils**  
277-279

---

**Sublimation**  
280

**TILGEAR**

2023/24 ISSUE 58

## Rotatrim Professional 'M' Series

- Precisely engineered for total cut precision, using only the finest quality, truly self sharpening, hand finished, tungsten steel blades.
- The dual chrome plated guide rails, completely eliminates head swivel with an effortless silent glide cut.
- Robust - built to last and to be used 'all day, every day', solid laminated gridded baseboard, all metal end frames and head, aluminium square rule.
- Completely safe and easy to use. Ideal for use by school children and students of all ages.
- Total Precision Engineering and finest Sheffield steel blades, ensure precision trimming of even the thinnest slivers of material.

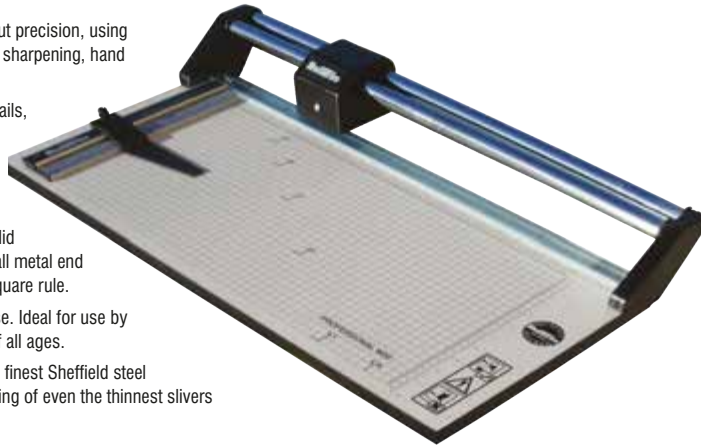

The professional will also cut these additional materials:-

- Canvas
- Heatseal
- Cork
- Honeycomb
- Corrugated Card
- Polystyrene
- Encapsulations
- Reflective Film
- Felt
- Veneers
- Floor Graphics



CODE	Cut length	Paper Size	Overall Length	Cut Capacity	Weight	Unit	1+
RTT300PRM	455mm/18"	A3	620mm	3.0mm	6.0kg	1	<b>135.00</b>
RTT333PRM	510mm/20"	A3+	660mm	3.0mm	6.4kg	1	<b>146.25</b>
RTT200PRM	610mm/24"	A2	778mm	3.0mm	7.1kg	1	<b>163.25</b>
RTT222PRM	763mm/30"	A2+	928mm	3.0mm	8.5kg	1	<b>188.50</b>
RTT100PRM	914mm/36"	A1	1080mm	2.0mm	8.9kg	1	<b>219.50</b>
RTT111PRM	1068mm/42"	A1+	1234mm	1.5mm	10.5kg	1	<b>258.25</b>
RTT000PRM	1374mm/54"	A0	1539mm	1.5mm	12.0kg	1	<b>314.50</b>

Overall Model Dimensions: Length (as above) Width: 382mm Height: 95mm.

## Ultraslim Lightbox



- Dimmable energy efficient LED lighting.
- Consistent light across the whole panel face.
- 2m USB cable for use through Computer Laptop.
- Mains UK/EU Plug with USB slot.
- Available in either A4, A3 or A2.

CODE	Description	Unit	4+	1+
LTB400LED	A4	1	<b>59.50</b>	69.50
LTB300LED	A3	1	<b>79.50</b>	95.00
LTB200LED	A2	1	<b>115.00</b>	129.50

## Prory Drawing Board A1, A2 or A3



- The Prory has an aluminium straight edge which runs the full width of the drawing board and features a precision machined 15mm transparent acrylic blade.
- Unique angle adjustment system holds the welded steel frame rigidly at thirteen different working positions.
- Featuring a continuous cross-wire parallel motion.
- The bottom of the straight edge is rebated which allows ink pens to be used without smudging.
- Generous board dimensions: A3 470 x 370mm, A2 650 x 470mm and A1 920 x 650mm.
- Storage units available - please enquire.

CODE	Description	Unit	4+	1+
DWB300PRY	A3	1	<b>102.25</b>	107.73
DWB200PRY	A2	1	<b>122.95</b>	129.11
DWB100PRY	A1	1	<b>147.95</b>	155.33

## Bretton Drawing Board A1, A2 or A3



- The Bretton is a portable, light-weight drawing board featuring a continuous cross-wire parallel motion.
- When folded flat the Bretton legs form a carry handle and in the raised position form a working angle on the desktop.
- Aluminium straight edge which runs the full width of the drawing board and features a precision machined 15mm transparent acrylic blade.
- The bottom of the straight edge is rebated which allows ink pens to be used without smudging.
- Generous board dimensions: A3 470 x 370mm, A2 650 x 470mm and A1 920 x 650mm.
- Storage units available - please enquire.

CODE	Description	Unit	4+	1+
DWB300BRT	A3	1	<b>74.75</b>	78.38
DWB200BRT	A2	1	<b>79.50</b>	83.41
DWB100BRT	A1	1	<b>812.75</b>	853.10

## Flip-Top Drawing Board



- A flip-top reversible desk - an ideal way to save space in the classroom.
- Acts as a normal desk but in addition has a drawing board mounted underneath which may be brought in to use by revolving the centre section of the drawing table.
- A2 size drawing board which has the same features as the Prory.
- The 1250mm desk can also be supplied in other sizes or a cantilever style - please ask for details.

CODE	Description	Unit	1+
DWB125FTD	A2	1	<b>495.00</b>

## A3 Drawing Board

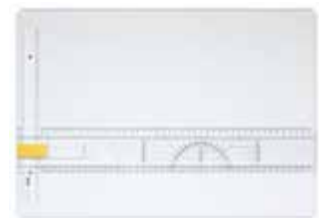

- Cost effective drawing board suitable for schools and colleges.
- Board made of impact-resistant plastic with anti-slip on the underside of the board.
- Clip for safe positioning of the paper.
- Central protractor with inverse scale.
- Handle with integrated push-button locking of the straight-edge.

CODE	Description	Unit	10+	4+	1+
DWB300EDU	A3	1	<b>36.50</b>	38.75	42.75

### Plan Chest A0 or A1



- A simple but highly effective wooden plan chest providing a smart and modern way to store paper in a school or college environment.
- Supplied in either A1 or A0 size, featuring steel legs and metal bow handles.
- 6 drawer version with 68mm deep drawers and finished in a hard wearing MFC with light oak grain surface.
- Available in other configurations and colours - please enquire.

CODE	Description	Unit	12+	6+	1+
PCH6010AK	A1	1	650.00		
PCH6000AK	A0	1	795.00		

### Drawing Board Clips



- Traditional spring clip to secure paper to a standard drawing board.
- Plated finish.
- Accommodates standard board thicknesses.

CODE	Description	Unit	12+	6+	1+
DBC004PAK	Clips	Pack of 4	2.40	2.60	2.90
DBC100PAK	Clips	Pack of 100			34.95

### Ellipse Template Stencil

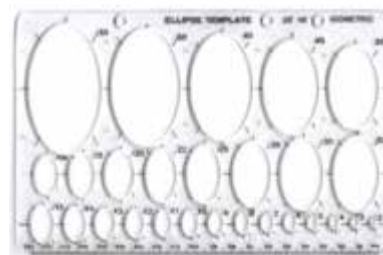

- 13cm x 21cm stencil for drawing ellipses or circles in 35° isometric perspective.
- Ellipses from 2mm to 50mm.
- Major and Minor axes marked on each ellipse.
- 190mm ruler. Holes for ring binders.

CODE	Description	Unit	4+	1+
ELT500STN	Ellipse Template Stencil	1	2.60	2.95

### Wooden T-Square



- Traditional hardwood wooden t-squares designed for school use.
- Academic grade t-squares are economically priced for the classroom.
- Constructed of seasoned hardwood with a natural wood finish.
- The edges are smooth for drafting and drawing.

CODE	Description	Unit	4+	1+
TSQ650HRW	A2 - 650mm	1	14.50	16.25

### Flexible Curve Rule

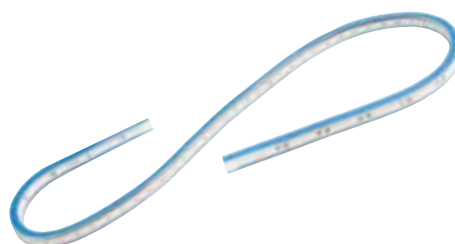

- A graduated flexible rule with a lead core to hold the rule to a desired arc.
- Ideal for transferring curved shapes and lines.

CODE	Description	Unit	4+	1+
FRC024600	600mm	1	7.50	7.95

### French Curves Set of 3



- Set of 3 French Curve templates for design drawings.
- Use to draw smooth curves of almost any desired curvature.
- Transparent plastic for easy positioning.
- Approximate lengths: 13.5cm, 17cm, 32cm.

CODE	Description	Unit	4+	1+
FRC300SET	French Curves Set of 3	1	4.30	4.95

### Helix Plastic T-Square



- Large plastic t-square with a wide stock.
- Parallel 650mm rule, graduated on both sides.
- The edges are smooth for drafting and drawing.

CODE	Description	Unit	4+	1+
HLX650TSQ	650mm	1	10.25	11.25

### Circle Template Stencil

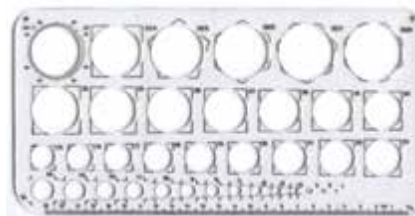

- 13cm x 26cm stencil for drawing circles up to 36mm diameter in 1mm increments.
- 230mm ruler. Includes circular protractor graded in 5° increments.
- 4 corners of stencil cut to different radii for drawing 90° circular arcs.

CODE	Description	Unit	4+	1+
CRT360STN	Circle Template Stencil	1	2.60	2.95

### Lettering Stencils Set of 4



- Set of 4 lettering and numbering stencils from 5 to 30mm.
- 5mm and 10mm stencils include upper and lower case.
- Upper case only on 20mm and 30mm stencils.

CODE	Description	Unit	4+	1+
LTS530SET	Lettering Stencils 5 - 30mm	1	2.40	2.70

Drawing Equipment

## Clear Plastic Ruler 30cm/12" - Pack of 20



- Clear plastic ruler 30cm/12" with both imperial and metric measurements.
- Non-shatter resistant.

12mm x 33m

CODE	Description	Unit	4+	1+
RUL312PLA	30cm/12"	Pack of 20	<b>4.50</b>	4.95

## Set Square 45 & 60 degree

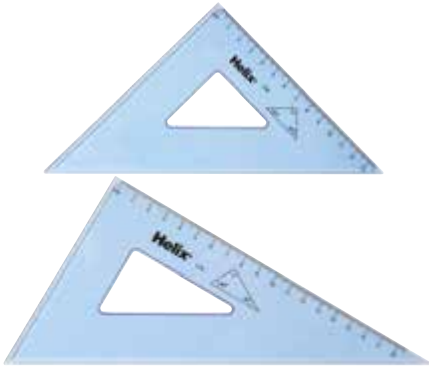

- 260mm.
- Printed metric scale.
- Ideal for National Curriculum Design & Technology.

CODE	Description	Unit	25+	10+	1+
HLX426SSQ	45°/260mm	1	<b>2.80</b>	2.95	3.30
HLX626SSQ	60°/260mm	1	<b>2.80</b>	2.95	3.30

## Protractor 180 Degree 129mm



- Clear plastic 180 degree protractor.
- 129mm/5".

CODE	Description	Unit	12+	4+	1+
PRR129STD	129mm	1	<b>0.65</b>	0.70	0.80

## Board Equipment

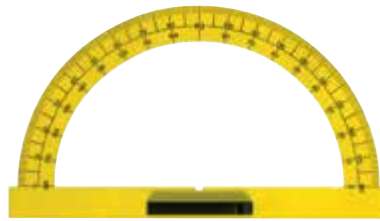

Board Protractor HLX360PRT



Board Ruler HLX100RUL

- Large yellow plastic.

CODE	Description	Unit	2+	1+
HLX360PRT	450mm	1	<b>13.75</b>	15.25
HLX100RUL	1m	1	<b>18.50</b>	20.50

## Board Compass



- Large yellow plastic.
- With adaptor, sucker and point.
- Opening to 450mm.

CODE	Description	Unit	2+	1+
HLX450CMP	Board Compass	1	<b>25.50</b>	28.25

## USB Memory Stick 16GB



- Popular capless swivel design.
- 16GB capacity.

CODE	Description	Unit	2+	1+
USB160TGR	16GB	1	<b>5.50</b>	6.25

## Ecobra Compass



- A high quality compass made by Ecobra of Germany. This model has been specifically designed for educational use in colleges and schools for accuracy and simplicity of use.
- Smooth action centre wheel adjuster holds the compass rigidly.
- Professional satin chrome finish.
- Overall length 160mm.

CODE	Description	Unit	4+	1+
CMP160PRO	Ecobra Compass	1	<b>11.25</b>	12.25

## Technical Compass



- 130mm quality metal compass.
- Adjustable knees for small circles.
- 2mm lead size.

CODE	Description	Unit	10+	4+	1+
HLX130CMP	Technical Compass	1	<b>6.95</b>	7.50	8.25

## Basic Compass



*Pencil not included*

- Metal, with shortened point.
- Self-centring mechanism.
- Overall length 107mm.

CODE	Description	Unit	25+	10+	1+
HLX107CMP	107mm	1	<b>2.10</b>	2.30	2.60

**Fineliner Pen 0.4mm**  
Pack of 10



- A reliable budget fineliner with water-based ink.
- Non-toxic with a good writing quality.

CODE	Description	Unit	6+	1+
PFN010BLK	Fineliner 0.4mm Pack of 10		2.75	2.95

**Fineliner Pens Assorted**  
Pack of 10



- These Fineliners have a metal supported fibre tip and uses water-based, non-toxic ink.
- The cap is as per ink colour and ventilated for safety.
- Assorted wallet of 10

CODE	Description	Unit	4+	1+
PFN010SET	Fineliners Ass Pack of 10		1.75	1.95

**Uni Pin Drawing Pen Set**  
Pack of 5



- A high precision fine tip for very precise and detailed work.
- Ideal for artwork, sketches, stencils and technical drawing.
- Smooth line with reliable ink flow.
- Odour free water based pigment ink that is waterproof and fade resistant.
- Contents:- 1 each of 0.05mm, 0.1mm, 0.3mm, 0.5mm and 0.8mm pens.

CODE	Description	Unit	6+	1+
UNM500PND	Drawing Pen Set Pack of 5		8.75	9.50

**Uni Pin Drawing Pen**



- A high precision fine tip for very precise and detailed work.
- Ideal for artwork, sketches, stencils and technical drawing.
- Smooth line with reliable ink flow.
- Odour free water based pigment ink that is waterproof and fade resistant.

CODE	Description	Unit	6+	1+
UNM005PND	0.05mm	1	1.95	2.25
UNM010PND	0.1mm	1	1.95	2.25
UNM030PND	0.3mm	1	1.95	2.25
UNM050PND	0.5mm	1	1.95	2.25
UNM080PND	0.8mm	1	1.95	2.25

**Colouring Pens Fine Point**  
Pack of 288



- A colouring pen with a fine tip, made to the highest safety standards.
- Non-toxic ink that is super-washable.

CODE	Description	Unit	1+
CPN288FNP	Fine Pack of 288		28.95

**Colouring Pens Broad Medium**  
Pack of 288



- A colouring pen with a broad conical tip, made to the highest safety standards.
- Washable, water-based and non-toxic ink in a variety of vibrant colours.

CODE	Description	Unit	1+
CPN288BRP	Broad Medium Pack of 288		39.95

**Uni Posca Medium Bullet Tip**  
Pack of 8



- Posca writes on virtually any surface; metal, wood, canvas, plastic, fabric, etc, and will not 'bleed through' paper.
- Water-based pigment ink to produce poster-paint-like vibrant colours.
- Easily removed from glass, making it ideal for temporary signs and window art.
- Alcohol free, solvent free.
- Colours: Black, Green, Blue, Violet, Red, Pink, Yellow, White.

CODE	Description	Unit	6+	1+
UNM800PSC	Posca Set Pack of 8		23.75	25.95

**Colouring Pencils**  
Packs of 12 or 24



- Hexagonal colouring pencils.
- Quality wood with 3mm lead diameter.
- Standard size barrels.

CODE	Description	Unit	1+
CPL012ASS	Colouring Pencils Pack of 12		0.95
CPL024ASS	Colouring Pencils Pack of 24		2.25

**Colouring Pencils**  
Bulk Packs, 144, 288 or 504



- Value Classbox of 144, 288 or 504.
- Hexagonal barrels with 3mm lead diameter.
- 12 assorted colours per box.

CODE	Description	Unit	1+
CPL144ASS	Colouring Pencils Pack of 144		13.95
CPL288ASS	Colouring Pencils Pack of 288		28.25
CPL504ASS	Colouring Pencils Pack of 504		47.25

## Propelling Mechanical Pencil Standard 0.7mm Pack of 10



- Refillable mechanical pencil which contains 3 x Japanese style leads.
- With an end eraser.

CODE	Description	Unit	4+	1+
MPN710STD	StandardSet	Pack of 10	2.75	2.95

## Propelling Mechanical Pencil Pro 0.7mm Pack of 10



- Japanese quality mechanical pencil with a light blue barrel and ridged grip.
- Fittings and handy pocket clip are metal, with a white eraser concealed under fitting.

CODE	Description	Unit	4+	1+
MPN710PRO	Pro	Pack of 10	5.95	6.50

## Leads for Propelling Pencils 0.7mm Pack of 12



- Black Japanese style leads packed in small tubes of 12.
- Used to refill mechanical pencils.

CODE	Description	Unit	4+	1+
MPN712LED	Spare Leads	Pack of 12	2.25	2.50

## HB Pencils Half Length Pack of 144

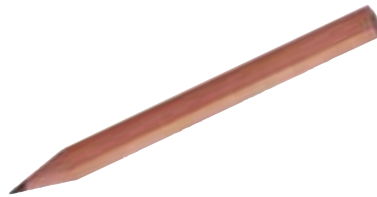

- Half length HB pencil made from responsibly managed hardwood.
- Ideal for use in the workshop and in compasses.

CODE	Description	Unit	4+	1+
PCL144HLF	Half Length	Pack of 144	3.95	4.50

## Graphite Pencils Pack of 12



- For use in the classroom or office.
- Hexagonal shaped barrel in standard size.
- Quality HB graphite lead.

CODE	Description	Unit	1+
PCL012GHB	HB Graphite Pencils	Pack of 12	2.20

## Bulk HB Pencils Box of 144 or 500



- Classbox of 144 graphite pencils in the popular HB grade.
- Hexagonal body.
- Handy dispenser box.

CODE	Description	Unit	1+
PCL144GHB	HB pencils	Pack of 144	10.95
PCL500GHB	HB pencils	Pack of 500	39.95

## Assorted Sketching Pencils Pack of 6



- High quality Classmaster branded hexagonal pencils.
- Strong, break resistant leads - ideal for school use.
- Specially formulated to provide excellent writing, sketching and shading properties.
- Grades B to 6B.

CODE	Description	Unit	1+
PCL120GAS	Assorted Sketching Pencils	Pack of 6	0.95

## Faber-Castell Goldfaber Pencil 4H, 2H, HB, 2B or 4B

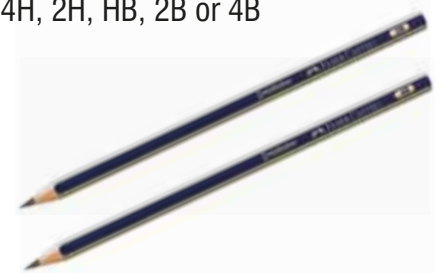

- Leads are SV-bonded securely to the entire length of the pencil to resist lead breakage.
- Versatile graphite pencils for art and sketching.
- Available in various grades.

CODE	Description	Unit	24+	12+	1+
FBC004HGP	4H	1	0.55	0.60	0.70
FBC002HGP	2H	1	0.55	0.60	0.70
FBC000HBP	HB	1	0.55	0.60	0.70
FBC002BGP	2B	1	0.55	0.60	0.70
FBC004BGP	4B	1	0.55	0.60	0.70

## Calligraphy Set



- Calligraphy set in a storage tin.
- Nib sizes: 0.85, 1.15 and 1.35mm.

CODE	Description	Unit	6+	1+
CAL300SET	Calligraphy	1	4.80	5.25

**Charcoal Set**



- Charcoal set in a storage tin.
- 3 charcoal pencils, 2 charcoal block, hard and soft torchon.

CODE	Description	Unit	6+	1+
<b>CHC500SET</b>	Charcoal	1	<b>4.95</b>	5.50

**Faber-Castell PITT Graphite Crayon 2B or 4B**



- Faber-Castell's PITT Graphite Pure leads are ideal for creating contrasts and shading extended areas.
- An economical medium for working on very large sketches and areas.
- Available in either 2B or 4B grades.

CODE	Description	Unit	24+	12+	1+
<b>FBC002GPH</b>	2B	1	<b>2.50</b>	2.75	2.95
<b>FBC004GPH</b>	4B	1	<b>2.50</b>	2.75	2.95

**Faber-Castell PITT Compressed Charcoal 2B or 4B**



- Faber-Castell's Medium Pitt Pressed sticks are the oldest sketching and drawing material in the world.
- Compressed charcoal with soot and clay give the charcoal pencils their deep black colour and are produced in different degree of hardness – medium or soft. Grease and oil free.
- Intense black.

CODE	Description	Unit	24+	12+	1+
<b>FBC900CCC</b>	2B	1	<b>1.60</b>	1.75	1.95
<b>FBC903CCC</b>	4B	1	<b>1.60</b>	1.75	1.95

**Watercolour Colouring Pencils Pack of 12**



- High quality water soluble pencils.
- Pack of 12 assorted colours.

CODE	Description	Unit	6+	1+
<b>CPL012WTC</b>	Watercolour Pack of 12		<b>2.20</b>	2.40

**Dual Tipped Art Markers**



- Art Markers with a dual tip - brush and fine point.
- Pack of 10 assorted colours.

CODE	Description	Unit	6+	1+
<b>AMK010DUL</b>	Dual Tipped	1	<b>6.75</b>	7.50

**Watercolour Brush Pens Pack of 12**



- Watercolour pens which be blended in the classical techniques.
- Pack of 12 assorted colours, plus a water brush.

CODE	Description	Unit	6+	1+
<b>BRP012WTC</b>	Watercolour Pack of 12		<b>5.50</b>	5.95

**Clam Heat Press**



- These Heat Transfer Press are offered in two versions, with print areas of 280mm x 380mm and 380 x 380mm, and an accurate temperature range from as low as 80c to 220c.
- LCD digital controller and easy to adjust pressure adjustment Complete with one year warranty on all parts and 10 year warranty on the cast aluminium heat platen.
- Conforms to all current legislation

CODE	Description	Unit	1+
<b>SUB280CHP</b>	280mm x 380mm	1	<b>375.00</b>
<b>SUB380CHP</b>	380mm x 380mm	1	<b>625.00</b>

**Maxi Swing Press**



- Professional unit for all transfer operations with a platen size of 380mm x 500mm and a high quality, cast aluminium frame.
- The swing head operation gives a perfect view of the transfer and garment allowing accurate and easy application, along with safety of operation.
- Fitted with a unique advanced computerised LED controller to accurately monitor both temperature and time settings.
- Pressure adjustment is by fingertip control and this press is suitable for both light and heavy pressure requirements.

CODE	Description	Unit	1+
<b>SUB500SWP</b>	Swing	1	<b>1395.00</b>

## Arc Mug Press



- Mug Press Comes complete with standard 10 – 11oz element.
- Complete with 1 year warranty.
- Satin mug wrap required for toner printed mugs.
- Additional elements can be purchased for 6oz mugs, latte mugs and shot glasses.

CODE	Description	Unit	1+
SUB101MUG	Mug	1	<b>235.25</b>

## White 10oz Mugs Pack of 36



- Satin coated white mug for sublimation.
- 10oz size.

CODE	Description	Unit	2+	1+
SUB361MUG	White 10oz	Pack of 36	<b>75.00</b>	79.50

## Sawgrass Sublimation Printer



- Sawgrass SG printers are designed specifically for sublimation and therefore offer some of the lowest startup costs of any product decorating technology.
- Equipped with WiFi capability, backlit LCD screens, and delivering higher image quality than previous models.
- Each printing system is fully integrated and includes everything you need, Sawgrass Print Manager, CreativeStudio Online Designer, SubliJet UHD Inks, In-house Sawgrass Support and a 2-year warranty.
- Available in A4 and A3, with a high ink capacity option on the A3

CODE	Description	Unit	1+
SUB500PRT	SG500 A4 + Inks	1	<b>349.00</b>
SUB103PRT	SG1000 A3 + inks	1	<b>995.00</b>
SUB203PRT	SG1000 A3 + High Cap Inks	1	<b>1050.00</b>

## Sawgrass Sublimation Paper Mug Size, A4 or A3



- Sublimation paper available in 3 popular sizes: Mug Size 210mm x 99mm, A4 and A3.

CODE	Description	Unit	4+	1+
SUB210SPP	Mug Size 300 Sheets	1	<b>16.75</b>	17.75
SUB400SPP	A4 200 Sheets	1	<b>25.75</b>	28.00
SUB300SPP	A3 100 Sheets	1	<b>25.75</b>	28.00

## Sublijet UHD SG500/SG1000 Ink Cartridge



- Standard capacity inks to suit Sawgrass SG500 and SG1000.

CODE	Description	Unit	1+
SUB031BLK	Black	1	<b>45.00</b>
SUB031CYN	Cyan	1	<b>45.00</b>
SUB031MGT	Magenta	1	<b>45.00</b>
SUB031YEL	Yellow	1	<b>45.00</b>

## Sublijet UHD SG1000 Ink Cartridge



- High capacity inks to suit Sawgrass SG1000.

CODE	Description	Unit	1+
SUB100BLK	Black	1	<b>50.50</b>
SUB100CYN	Cyan	1	<b>50.50</b>
SUB100MGT	Magenta	1	<b>50.50</b>
SUB100YEL	Yellow	1	<b>50.50</b>

## Waste Ink Collectors



- Waste ink collector for sublimation printers.

CODE	Description	Unit	1+
SUB450WCL	SG400	1	<b>67.50</b>
SUB810WCL	SG800/SG1000	1	<b>47.25</b>

## Ricoh SG3110DN/SG7100DN Ink Cartridge



- Standard capacity inks to suit Ricoh SG3110DN and SG7100DN.

CODE	Description	Unit	1+
SUB371BLK	Black	1	<b>64.75</b>
SUB371CYN	Cyan	1	<b>47.25</b>
SUB371MGT	Magenta	1	<b>47.25</b>
SUB371YEL	Yellow	1	<b>47.25</b>

## Sublijet HD SG400/SG800 Ink Cartridge



- Standard capacity inks to suit Sawgrass HD SG400 and SG800.

CODE	Description	Unit	1+
SUB480BLK	Black	1	<b>61.75</b>
SUB480CYN	Cyan	1	<b>45.00</b>
SUB480MGT	Magenta	1	<b>45.00</b>
SUB480YEL	Yellow	1	<b>45.00</b>



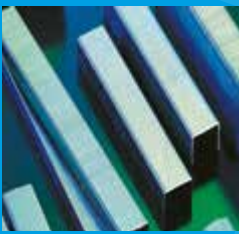

# Stationery

**Pens**  
282

**Sharpeners, Erasers and Scissors**  
283

**Office Equipment**  
284-285

**Office Consumables**  
285-287



Pens

## Ball Point Pen Pack of 50



- A good quality medium point ball point pen with a round transparent barrel.
- Ink colour as cap.

CODE	Description	Unit	4+	1+
ALP050MBK	Black	Pack of 50	<b>2.95</b>	3.50
ALP050MRD	Red	Pack of 50	<b>2.95</b>	3.50
ALP050MBL	Blue	Pack of 50	<b>2.95</b>	3.50
ALP050MGR	Green	Pack of 50	<b>2.95</b>	3.50

## Quad Colour Pen Pack of 10



- A high quality ball point pen with four medium point colour options.
- A rubber grip for comfort, stylish bright purple barrel and a pocket clip.
- Available in Standard with Black, Blue, Green and Red inks or in Bright with Purple, Pink, Sky Blue and Lime Green inks.

CODE	Description	Unit	1+
PEN410BRT	Bright	Pack of 10	<b>11.25</b>
PEN410STD	Standard	Pack of 10	<b>11.25</b>

## Bic Cristal Ballpoint Pens Black or Blue Pack of 10



- Original Bic Cristal ballpoint pen - standard 1.0mm point.
- Available in either Black or Blue.

CODE	Description	Unit	10+	5+	1+
BIC010BLK	Black	Pack of 10	<b>3.10</b>	3.20	3.50
BIC010BLU	Blue	Pack of 10	<b>3.10</b>	3.20	3.50

## Uni-ball Eye Fine Rollerball Pen



- Uni-ball's Eye pen has been one of the world's favourite rollerballs for over 20 years.
- Contains uni Super Ink, which is fade resistant, water resistant and tamper proof.
- Unique 'uni-flow' system ensures a continuous flow of ink right down to the last drop.

CODE	Description	Unit	6+	1+
UNM446RBK	Black	1	<b>2.60</b>	2.95
UNM453RBU	Blue	1	<b>2.60</b>	2.95
UNM451RRD	Red	1	<b>2.60</b>	2.95

## Sharpie Fine Tip Permanent Markers Pack of 4 Assorted or Pack of 5 Black



- Renown Sharpie brand of permanent Markers - reliable and consistent.
- Pack of 4 assorted colours or pack of 5 black.

CODE	Description	Unit	12+	6+	1+
SHR004ASS	Fine Tip	Pack of 4	<b>6.50</b>	6.75	7.50
SHR005BLK	Black	Pack of 5	<b>7.25</b>	7.75	8.50

## Permanent Markers Bullet Tip Assorted Pack of 4 or Black Pack of 10



- Water-resistant ink writes on most surfaces.
- 6 day cap-off time to prevent drying out.

CODE	Description	Unit	1+
PEN204BAS	Assorted Colours	Pack of 4	<b>1.50</b>
PEN211BBL	Black	Pack of 10	<b>3.50</b>

## Permanent Markers Chisel Tip Pack of 10



- Water-resistant ink writes on most surfaces.
- 6 day cap-off time to prevent drying out.
- Ventilated caps and xylene-free, toluene-free ink
- Chisel tip.

CODE	Description	Unit	1+
PEN311CBL	Black	Pack of 10	<b>3.50</b>

## Drywipe Markers Assorted Pack of 4 or Black Pack of 10



- 24 hour cap off time to prevent drying out.
- Pressure resistant tips, ventilated caps and xylene-free, low odour ink.

CODE	Description	Unit	1+
PEN404DAS	Assorted Colours	Pack of 4	<b>1.75</b>
PEN411DBL	Black	Pack of 10	<b>3.75</b>

## Drywipe Bullet Pen Pack of 48



- A drywipe bullet tip marker with a large capacity barrel with coloured cap and clip for convenience.
- Alcohol based ink which is erasable with a dry cloth from most non-porous surfaces.
- Bulk packs in either Assorted (Black, Blue, Green and Red) or Black only.

CODE	Description	Unit	1+
PEN048DBL	Black	Pack of 48	<b>17.95</b>
PEN048DAS	Assorted	Pack of 48	<b>17.95</b>

### Highlighter Pens

Pack of 4 or 48



- Traditional square highlighter with bright coloured inks, denoted by the barrels colour.
- The non-toxic, cap off ink can be used to highlight on all paper types without fading.

CODE	Description	Unit	4+	1+
HLP048ASS	Bulk	Pack of 48	<b>13.75</b>	
HLP400SET	Assorted	Pack of 4	<b>1.15</b>	1.25

### Whiteboard Eraser

Magnetic



- Magnetic whiteboard erasers are compatible with all magnetic board surfaces.
- Can be used dry or with whiteboard cleaner.

CODE	Description	Unit	4+	1+
ERS127WBR	Large	1	<b>1.75</b>	<b>1.95</b>

### Plastic Single Hole Sharpener

Assorted Pack of 100



- Square plastic sharpener with a quality steel blade.
- Single hole type in an assortment of colours.

CODE	Description	Unit	1+
PSH100ASS	Single Hole	Pack of 100	<b>4.75</b>

### Aluminium Single Hole Sharpener

Pack of 24



- Lightweight aluminium pencil sharpener made with quality steel blades.
- Single hole type.

CODE	Description	Unit	1+
PSH124SGL	Single	Pack of 24	<b>2.50</b>

### Aluminium Double Hole Sharpeners

Pack of 12



- Lightweight aluminium pencil sharpener made with quality steel blades.
- Double hole type.

CODE	Description	Unit	1+
PSH212DBL	Double Hole	Pack of 12	<b>3.25</b>

### Barrel Type Sharpener

Pack of 10



- Barrel or canister sharpeners for easy and tidy pencil sharpening.
- Metal sharpener with quality steel blades is set into the lid.
- Available with one or two holes.

CODE	Description	Unit	1+
PSH110BRR	Barrel Single	Pack of 10	<b>4.95</b>
PSH210BRR	Barrel Double	Pack of 10	<b>6.75</b>

### Plastic Erasers

Pack of 45



- Excellent quality white plastic eraser.
- Erases graphite from paper without smudging or tearing.
- Each eraser is individually shrink wrapped to maintain freshness.
- 45 erasers 32 x 23 x 9mm.

CODE	Description	Unit	1+
ERS324PLA	Plastic Erasers	Pack of 45	<b>3.95</b>

### Plastic Erasers

Pack of 20



- Excellent quality white plastic eraser.
- Erases graphite from paper without smudging or tearing.
- Each eraser is individually shrink wrapped to maintain freshness.
- 20 erasers 60 x 22 x 16mm.

CODE	Description	Unit	1+
ERS622PLA	White Plastic Erasers	Pack of 20	<b>2.95</b>

### TPR Plastic Eraser

Pack of 20



- Excellent value eraser with a cardboard sleeve.
- Made from TPR plastic, without containing PVC or latex.
- Size 50mm x 20mm.

CODE	Description	Unit	4+	1+
ERS522PLA	50mm x 20mm	Pack of 20	<b>2.75</b>	2.95

## Scissors Pack of 12



- Stainless steel scissors with a black ABS plastic hand grip designed for comfort.
- Available in 6 and 8 inch sizes.

CODE	Description	Unit	4+	1+
SCS612PAK	6"	1	7.25	7.95
SCS812PAK	8"	1	10.50	11.50

## Scissors Block and 32 Scissors



- Holder complete with 32 pairs of small students scissors.
- Convenient wooden storage tidy.
- 26 right-handed and 6 left-handed per set.
- Overall size - 133mm (5.25").

CODE	Description	Unit	4+	1+
SCS320SET	Block and 32 Scissors	1	17.95	19.75

## 26/6 Staples Pack of 5000



- Precision engineered anti-jam staples for trouble-free use.

CODE	Description	Unit	1+
STP266PAK	26/6 Staples	Pack of 5000	0.95

## Stainless Steel Scissors 165mm



- Popular scissors manufactured from quality stainless steel
- Blades are precision ground and set for optimum performance.
- Overall length 165mm, with a 68mm cutting length.

CODE	Size	Unit	12+	4+	1+
SCS165PRG	165mm	1	2.20	2.40	2.70

## Heavy Duty Hole Punch



- 40 sheet punching capacity (80gsm).
- Adjustable paper guide and lock-down facility.
- Hardened cutters.

CODE	Description	Unit	1+
HPU040HDT	Hole Punch	1	8.25

## Single Hole Paper Punch 6mm



- Single 6mm hole punch - ticket style.
- Chrome plated steel.

CODE	Description	Unit	4+	1+
HPU006TCK	6mm	1	2.05	2.30

## Soft Grip Scissors 6.5" or 8.25"



- Soft grip BioGuard handles which are antibacterial and dishwasher safe.
- High quality stainless steel and ground for clean precise cutting.
- Available in two sizes: 6.5" with a 56mm cutting length and 8.25" with 82mm cutting length.

CODE	Description	Unit	12+	4+	1+
SCS650SGP	6.5"	1	2.95	3.20	3.50
SCS825SGP	8.25"	1	3.90	4.20	4.70

## Executive Half Strip Stapler



- Very robust, manufactured from strong ABS with an inner metal chassis and a 20 year guarantee.
- High loading capacity – loads 150 x 26/6 or 120 x 24/6 staples (standard staplers only load 105 x 26/6 staples).
- 20 sheet stapling capacity.

CODE	Description	Unit	1+
STP200HST	Half Strip Stapler	1	2.50

## Staple Remover



- Made of metal with a lock.
- Black plastic grips designed for comfort.

CODE	Description	Unit	4+	1+
STP001RMV	Remover	1	0.40	0.50

## Wooden Ruler



- Traditional wooden rule 30cm/12".

CODE	Description	Unit	24+	12+	1+
RUL300WDN	Wooden	1	<b>0.85</b>	0.90	1.05

## Rule & Trimmer



- Wide rule with an integral trimming blade which slides the width.
- Safe and easy to use when on a cutting mat.
- A4 Size.

CODE	Description	Unit	12+	6+	1+
TRM004RUL	Rule & Trim	1	<b>4.30</b>	4.70	5.25

## Rotary Paper Trimmer



- Rotary blade cuts in both directions.
- Available in either A4 (cutting width 321mm) or A3 (cutting width 460mm) size.
- A4 cuts up to 10 sheets of paper and A3 up to 8 sheets, in one pass.

CODE	Description	Unit	2+	1+
TRM400RTY	A4	1	<b>22.50</b>	25.25
TRM300RTY	A3	1	<b>27.95</b>	31.50

## Clear Gloss Laminating Pouches A3 or A4 Pack of 100



- Polyester (PET) gloss, thickness: 150 microns.
- Water resistant, alteration resistant, damp resistant, pest resistant and mildew resistant.
- Good transparency.
- Improved oxygen barrier over other materials.

CODE	Description	Unit	2+	1+
LMP154PAK	A4	Pack of 100	<b>10.75</b>	11.75
LMP153PAK	A3	Pack of 100	<b>18.25</b>	20.25

## Pocket Sized 8 Digit Dual Power Calculator



- Pocket sized, with its own flip wallet to protect from dust and swarf.
- Dual battery power (Battery/Solar) - use it anywhere!
- 8 digit display with a 3 Key memory.

CODE	Description	Unit	10+	4+	1+
CAL809DUL	Calculator	1	<b>3.25</b>	4.50	4.75

## Yellow Repositional Notes Pack of 12 x 100 sheets



- Standard yellow measures 75 x 75mm and are supplied in a pack of 12 bundles of 100 sheets
- Will stick to most surfaces.

CODE	Description	Unit	3+	1+
RNT757PAK	Yellow	12 x 100 Sheets	<b>5.00</b>	5.50

## Ring Binder A4



- Standard folder with 2 rings.
- A4 Black.

CODE	Description	Unit	10+	5+	1+
RBR400BLK	A4	1	<b>2.10</b>	2.30	2.50

## Lever Arch File



- Lever arch design with 2 rings.
- A4 Black.

CODE	Description	Unit	5+	1+
LAR400BLK	A4	1	<b>3.50</b>	3.80

## Box File



- Box file with a lockspring mechanism to help secure the contents.
- Lid catch and finger hole.
- A4 Black.

CODE	Description	Unit	5+	1+
BFL400BLK	A4	1	<b>6.95</b>	7.50

## A4 Protective Punched Pockets

Pack of 100 or 500



- Plastic punched pocket sheet protector with an orange peel effect.
- Pockets have a 30 micron thickness.
- A4 size.

CODE	Description	Unit	10+	5+	1+
PPP104PAK	A4	Pack of 100	<b>2.50</b>	2.75	3.25
PPP504PAK	A4	Pack of 500			<b>11.75</b>

## A-Z Subject Dividers A4

Pack of 20



- 20 A-Z 160gsm dividers.
- A4 multicoloured.

CODE	Description	Unit	10+	5+	1+
SDV020ATZ	20 Part	Pack of 20	<b>2.95</b>	3.20	3.50

## Extra Strong Subject Dividers A4

Pack of 5 or 10



- 5 or 10 polypropylene extra strong dividers for ring binders.
- A4 multicoloured.

CODE	Description	Unit	20+	10+	1+
SDV054EXS	5 Part	Pack of 5	<b>0.95</b>	0.95	1.10
SDV104EXS	10 Part	Pack of 10	<b>0.55</b>	0.60	0.65

## Presentation Display Book

A4, A3 or A2 40 Pocket



- Display book with personalisable front cover.
- 40 crystal clear pockets, giving 80 pages to view.
- Available in A4, A3 and A2 sizes.

CODE	Description	Unit	12+	6+	1+
PDB404BLK	A4	1	<b>3.20</b>	3.40	3.80
PDB403BLK	A3	1	<b>5.00</b>	5.50	6.75
PDB402BLK	A2	1	<b>11.25</b>	11.95	13.25

## Mesh Storage Wallet

A4+ or A3



- Tough mesh wallet with a zip top.
- Available in A4+ (340 x 265mm) and A3 (455 x 325mm) sizes.

CODE	Description	Unit	24+	12+	1+
STW400MSH	A4+	1	<b>1.20</b>	1.25	1.40
STW300MSH	A3	1	<b>1.85</b>	1.95	2.20

## Paper Fasteners

Pack of 100



- Paper Fasteners with a split foldable shank.
- Bright plated finish.

CODE	Description	Unit	12+	6+	1+
PFS100PAK	19mm	Pack of 100	<b>1.90</b>	2.10	2.30

## Hook & Loop Fastening Tape



- Contains both hook and loop tapes in a 5m length.
- Self-adhesive backing.
- Colour white.
- 5m x 25mm wide.

CODE	Size	Unit	6+	1+
HLT525WHT	5m	1	<b>4.95</b>	5.50

## White Tack



- The Handy sized pack of re-useable adhesive tack – great alternative to pins or tape.
- No show through on white paper.
- No colour staining.

CODE	Description	Unit	5+	1+
WTK100PAK	White Tack	1	<b>0.75</b>	1.00

## Wizard Glue Sticks

Single or Pack of 100



- Quality PVP retractable glue stick made from non-toxic glue.
- Repositionable for up to 2 minutes.
- Confirms to CE standards.

CODE	Description	Unit	10+	1+
GLS020LRG	20g x 1	1	<b>0.35</b>	0.40
GLS120LRG	20g x 100	Pack of 100		<b>32.95</b>
GLS040LRG	40g x 1	1	<b>0.60</b>	0.65
GLS140LRG	40g x 100	Pack of 100		<b>49.95</b>

## Shorthand Notebook 160 Page



- Smooth, crisp, quality white paper.
- 160 pages, 203 x 127mm.

CODE	Description	Unit	10+	5+	1+
SHN160PAD	Shorthand	1	0.65	0.70	0.75

## Copier Paper A4 Pack of 500 or A3 Pack of 100



- Superior quality white copier paper.
- Available in A4 (Pack of 250) or A3 (Pack of 500) - 80gsm.

CODE	Description	Unit	10+	5+	1+
CPP504PAK	A4 80gsm Pack of 550			7.50	7.95
CPP803PAK	A3 80gsm Pack of 100		4.10	4.30	4.80

## Ergo Wireless Mouse



- Ergonomically designed body with smooth operation and silent click.
- Power saving mode and metallic scroll wheel.
- 10m range and supplied with a nano receiver.

CODE	Description	Unit	3+	1+
MSE200WLS	Wireless	1	17.95	19.95

## Refill Pad Top Bound A4



- Standard lined refill pad.
- A4, 160 page, bound at the top.

CODE	Description	Unit	10+	5+	1+
RFL164PAD	A4	1	1.35	1.45	1.60

## Photo Inkjet Paper A4 Pack of 20



- Photo inkjet paper 210gsm for copiers.
- A4 - pack of 20.

CODE	Description	Unit	12+	6+	1+
PHT420PAK	Photo Paper Pack of 20		5.75	5.95	6.75

## Assorted Rubber Bands 1lb/450g Pack



- Popular pack of rubber bands in assorted widths and lengths.

CODE	Description	Unit	4+	1+
RBB450ASS	Assorted	1	6.50	7.50

## Spiral Notebook 5mm Squares



- Spiral bound notebook with 5mm squared paper.
- Portrait A4, 160 page.

CODE	Description	Unit	10+	5+	1+
SNB164SQU	A4	1	1.50	1.60	1.75

## Clear Book Cover Film



- Clear self-adhesive book film for presentation and extending cover life.
- 500mm x 5m

CODE	Description	Unit	5+	1+
BCF505CLR	Clear Book Cover Film	1	3.10	3.40

## Wizard Invisible Tape Pack of 8



- A high quality matt adhesive tape 19mm wide x 33m long.
- Can be written on with a ball pen.
- Virtually invisible when used on photocopied documents, etc.
- Temporarily repositionable.

CODE	Description	Unit	5+	1+
WTP819MAT	19mm x 33m Pack of 8		2.75	2.95



# Food Technology

---

**Janitorial Supplies & Safety Products**  
289-290

---

**Food Preparation & Baking**  
291-292

---

**Small Appliances & Food Storage**  
292-293

---

**Utencils, Tablewear & Cookware**  
294-296





## Hand Towel Dispenser



- Attractive and economical plastic dispenser.
- Universal refills suitable for most dispensers.

CODE	Description	Unit	1+
HTL100DSP	Hand Towel Dispenser	1	<b>27.00</b>

## C-Fold Hand Towel White Pack of 2880 Sheets



- Each sheet is folded into the preceding one for individual sheet by sheet dispensing.
- Universal refills suitable for most dispensers.

CODE	Description	Unit	1+
HTL2SQCFD	C-Fold Hand Towel	Pack of 2880 Sheets	<b>27.00</b>

## Reflex Wipe Dispenser



- Reflex wipe, single sheet centrefold dispensing system delivering a fast and controlled wiping solution to reduce costs, servicing time and cross-contamination.

CODE	Description	Unit	1+
RFX355DSP	Reflex Wipe Dispenser	1	<b>25.75</b>

## Blue Reflex Wipes Pack of 6



- Reflex wipes for dispensing system.
- Centre-feed or conventional, 190mm wide x 120m long.

CODE	Description	Unit	1+
RFX555BLU	Blue Reflex Wipes	Pack of 6	<b>20.75</b>

## Blue Cloths Pack of 50



- Non-woven, resin-bonded cloths with excellent wiping capability.
- Size 330mm x 580mm.

CODE	Description	Unit	1+
CLH050BLU	Blue Cloths	Pack of 50	<b>5.50</b>

## Bleached Dish Cloths Pack of 10



- 406 x 254mm (16" x 10").
- Excellent absorption.
- Can be laundered and bleached.

CODE	Description	Unit	1+
CLH160BLC	Bleached Dish Cloth	Pack of 10	<b>7.25</b>

## Black & White General Purpose Tea Towel Pack of 10



- Size 762mm x 508mm.
- Robust 95% cotton, 5% polyester.

CODE	Description	Unit	1+
TTW750BLK	Tea Towel	Pack of 10	<b>18.50</b>

## Liquid Soap



- 450ml self dispensing liquid soap.

CODE	Description	Unit	6+	1+
LSP450PRL	Liquid Soap	1	<b>4.00</b>	4.50

## Oven Gloves 36"



- 36" long.
- Double thick padding offering protection up to 150°C.

CODE	Description	Unit	1+
OGL360DBT	Oven Gloves 36"	1	<b>5.00</b>

## Spray Bottles 750ml



- 750ml plastic bottles with colour coded heads for easy identification.
- Millilitre markings on bottles allow for simple dilution of chemicals.
- The colours available are – Red, Yellow, Green, Blue.
- Size: 265mm(H) x 110mm(W) x 90mm(D).

CODE	Colour	Unit	1+
SBT701RED	Red	1	<b>3.25</b>
SBT702YEL	Yellow	1	<b>3.25</b>
SBT703GRN	Green	1	<b>3.25</b>
SBT704BLU	Blue	1	<b>3.25</b>

## Kentucky Mop Head



- Traditional 16oz cotton mop heads with stay-flat cut end finish and colour coded holders.
- Available in four colours – Red, Yellow, Green, Blue.

CODE	Colour	Unit	1+
KTM301RED	Red	1	7.00
KTM302YEL	Yellow	1	7.00
KTM303GRN	Green	1	7.00
KTM304BLU	Blue	1	7.00

## Mop Handle



- 216mm (54") long.
- Attaches in seconds without the need for fiddly screws.
- Available in four colours – Red, Yellow, Green, Blue.

CODE	Colour	Unit	1+
MOP201RED	Red	1	21.25
MOP202YEL	Yellow	1	21.25
MOP203GRN	Green	1	21.25
MOP204BLU	Blue	1	21.25

## Mop Bucket



- Easy to fill, polypropylene colour-coded buckets with increased working capacity.
- Max Capacity 16 Ltr.
- High Mop Sieve.
- Easy Pour Lip.
- Available in four colours – Red, Yellow, Green, Blue.

CODE	Colour	Unit	1+
MBU401RED	Red	1	29.25
MBU402YEL	Yellow	1	29.25
MBU403GRN	Green	1	29.25
MBU404BLU	Blue	1	29.25

## Swing Top Bin



- Lightweight, colour-coded and easy to clean 50 litre bins.
- Size: 710mm(H) x 330mm(W) x 320mm(D)
- Available in four colours – Red, Yellow, Green, Blue.

CODE	Colour	Unit	1+
BIN501RED	Red	1	32.50
BIN502YEL	Yellow	1	32.50
BIN503GRN	Green	1	32.50
BIN504BLU	Blue	1	32.50

## 50 Litre White Swing Bin Liner Pack of 1000



- High grade polythene bin liners.

CODE	Description	Unit	1+
BIN580LNR	Swing Bin Liner	Pack of 1000	20.25

## Wet Floor Sign



- Sturdy, free-standing, double-sided safety sign.
- Folds flat for easy storage.
- Carry handle.
- Easy-clean plastic construction.

CODE	Description	Unit	1+
WFS123FLD	Wet Floor Sign	1	9.25

## Self Adhesive Food Preparation Signs Pack of 14



Starter sign pack contains 14 notices, covering food hygiene and general kitchen safety.

### Contains:

1. Safe use of knives.
2. Staff smoking offence.
3. Prevent cross contamination.
4. Drinking water.
5. Personal Items.
6. Food preparation area.
7. Wash hands.
8. Keep cuts covered.
9. Cook chill guidelines.
10. Prevent food poisoning.
11. Leave basin clean.
12. Not suitable for drinking.
13. Food equipment only.
14. Food wash only

CODE	Description	Unit	1+
SGN140FPR	Food Preparation Sign	Pack of 14	44.50

## Self Adhesive Senior Hygiene Catering Signs Pack of 17



17 self-adhesive notices, covering food storage and general kitchen safety.

### Contains:

1. Food safety act.
2. Chopping board notice.
3. Cook chilled guideline.
4. Now wash your hands.
5. Sink for food wash.
6. Sink for utensils wash.
7. Sink for hand wash.
8. Raw meat only.
9. Cooked meat only.
10. Defrosted food must not be refrozen.
11. All foods must be covered.
12. Waste in bins provided.
13. Fish only.
14. Leave basin clean.
15. No smoking symbol.
16. Dangerous machine warning.
17. First aid symbol.

CODE	Description	Unit	1+
SGN170SHC	Snr Hygiene Catering Signs	Pack of 17	55.75

## Wooden Chopping Board



- Food grade chopping board, extremely hardwearing and tough.
- Size 12" x 18".

CODE	Description	Unit	1+
CPB128WDN	Wooden Chopping Board	1	<b>45.00</b>

## High Density Chopping Board

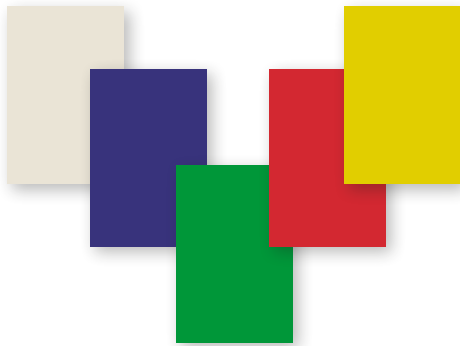

- Made from high quality polyethylene.
- They are non-absorbant, odourless, non-toxic and comply with all hygiene regulations.
- Available in five colours.
- Size 18" x 12" x ½".

CODE	Colour	Unit	1+
HDC182WHT	White	1	<b>15.75</b>
HDC182BLU	Blue	1	<b>15.75</b>
HDC182GRN	Green	1	<b>15.75</b>
HDC182RED	Red	1	<b>15.75</b>
HDC182YEL	Yellow	1	<b>15.75</b>

## Wooden Heat Triangle

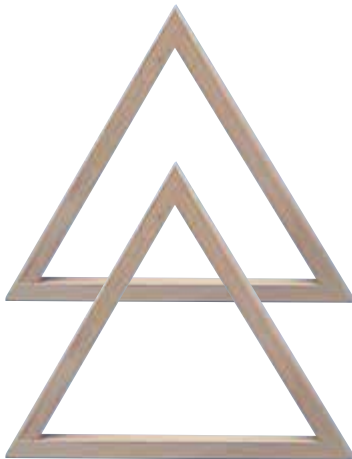

- Set of two wooden triangles - 7.25" and 9.5".

CODE	Description	Unit	1+
HTR792WDN	Wooden Heat Triangle	1	<b>9.00</b>

## Round Fluted Quiche Tin with Removable Base



- 320mm diameter.
- 25mm deep.

CODE	Description	Unit	1+
QTN320RMB	Removable Base	1	<b>22.50</b>

## Round Spring Form Cake Tin



- Available in five sizes all with a depth of 75mm.

CODE	Size	Unit	1+
CKT200SPF	200mm	1	<b>7.50</b>
CKT220SPF	220mm	1	<b>9.00</b>
CKT240SPF	240mm	1	<b>10.50</b>
CKT260SPF	260mm	1	<b>13.00</b>
CKT280SPF	280mm	1	<b>22.50</b>

## Loose Base Aluminium Sandwich Tin



- Provides even baking with no 'hot spots'.
- Two sizes available - 203mm (8") or 229mm (9").
- Loose base.

CODE	Size	Unit	1+
SWT203LSB	203mm / 8"	1	<b>19.00</b>
SWT229LSB	229mm / 9"	1	<b>20.75</b>

## Round Plain Biscuit/ Pastry Cutter Set 11 Piece



- 11 piece set available as fluted or plain cutters.
- Material: Mild Steel.
- Largest Diameter: 100mm.

CODE	Description	Unit	1+
PYC110RND	Plain	1	<b>14.50</b>
PYC110FLU	Fluted	1	<b>14.50</b>

## 12 Cup Bun Sheet



- Standard finish bun sheet with 12 deep cups.
- Ideal for baking buns, mince pies or open pastry tarts.
- Overall dimensions: 355mm(W) x 270mm(D).
- Cup size: 65mm(W) x 20mm(D).

CODE	Description	Unit	1+
BUN012CUP	12 Cup Bun Sheet	1	<b>9.25</b>

## 12 Cup Muffin Tray



- Non-stick bun tray with 12 deep cups.
- Ideal for baking buns, mince pies or open pastry tarts.
- Overall dimensions: 310mm(W) x 210mm(D).
- Cup size: 50mm(W) x 20mm(D).

CODE	Description	Unit	1+
MUF012CUP	12 Cup Muffin Tray	1	<b>17.25</b>

## Loaf Tin



- Carbon steel, non-stick loaf tin.
- High quality layered non-stick coating.
- Material: Carbon steel.
- Size: 78mm(H) x 250mm(W) x 100mm(D).

CODE	Description	Unit	1+
LAF202TIN	Loaf Tin	1	<b>15.75</b>

## Aluminium Foil 450mm x 75m



- Size: 450mm wide 75m long
- 12 gauge foil.

CODE	Description	Unit	1+
AFL450ALU	Aluminium Foil	1	<b>10.50</b>

## Baking Parchment 450mm x 50m



- Baking Parchment is silicone coated on both sides, providing a perfect non-stick surface for baking.
- Capable of baking up to 230°C or domestic freezing.
- The traditional white appearance and non-stick properties are obtained using environmentally friendly materials.
- Potato starch used - product is gluten and wheat free.
- Box dimensions: 82mm(H) x 482mm(W) x 83mm(D)mm. Weight: 1.06 kg.

CODE	Description	Unit	1+
BPM450RLL	Baking Parchment	1	<b>9.75</b>

## Cling Film 450mm x 300m



- 450mm (18") x 300m (1000ft) long.
- Supplied in cutter box.
- Box dimensions: 102mm(H) x 480mm(W) x 102mm(D).

CODE	Description	Unit	1+
CLF180RLL	Cling Film	1	<b>9.75</b>

## Kenwood Hand Mixer 450W



- Compact design for easy storage.
- 450W motor with 5 speeds.
- Stainless steel beaters and kneaders included.
- 1 year guarantee.
- Dimensions 210(H) x 110(W) x 220(D)mm.

CODE	Description	Unit	1+
KWD450HMX	Hand Mixer	1	<b>44.75</b>

## Plastic Kettle 1.7 litre



- General use cordless kettle with stainless steel heating element, removable filter, ergonomic handle, auto cut-off and water level indicator.

CODE	Description	Unit	1+
KTL170PLA	Plastic Kettle 1.7ltr	1	<b>29.25</b>

## Aluminium Baking Tray



- Size: 320mm x 215mm x 20mm deep.

CODE	Description	Unit	1+
BKS320ALU	Aluminium Baking Tray	1	<b>6.75</b>

## Kenwood Major Titanium Mixer



*Ring for the latest deals*

- The Kenwood Major Titanium has to be the ultimate kitchen mixer for every day use..
- Pop-up head for quick and easy tool change and bowl removal. Supplied with K-beater, wire whisk and dough hook.
- 1.7kW Motor.
- 6.7L Stainless steel bowl.
- Automatic speed control with pulse.
- Metal body and gears.

CODE	Description	Unit	1+
KWD830KMC	KVL8300S	1	<b>775.00</b>

## KitchenAid Mixer K45



*Ring for the latest deals*

- This KitchenAid mixer is powerful and quiet with direct drive motor.
- Robust, stable and durable full metal construction with smooth rounded design and tilt head for easy cleaning and usage.
- Supplied with 4.28 litre stainless steel bowl, flat beater, dough hook and wire whisk.
- 10 speed power control.
- 250W motor.
- Speed: 58-220rpm.
- Dimensions: 365mm(H) x 360mm(W) x 255mm(D).

CODE	Description	Unit	1+
KTA045MIX	KitchenAid Mixer K45	1	<b>460.00</b>

## Rectangular Foil Container Pack of 1000



- Foil takeaway container.
- Waxed lids sold separately.
- Suitable for hot and cold foods.

**260ml, 126mm x 100mm**

CODE	Description	Capacity	Unit	1+
FLC260CNT	Container	260ml	Pack of 1000	<b>61.75</b>
FLC260LID	Lids		Pack of 1000	<b>25.75</b>

## Rectangular Foil Container Pack of 500



- Foil takeaway container.
- Waxed lids sold separately.
- Suitable for hot and cold foods.

**688ml, 201mm x 109mm**

CODE	Description	Unit	1+
FLC688CNT	Container	Pack of 500	<b>65.25</b>
FLC688LID	Lids	Pack of 500	<b>22.00</b>

## Seal Fresh Lunch Box



- Complete with air-tight lids.
- Microwave, freezer and dishwasher safe.
- 60mm(H) x 140mm(W) x 195mm(D).

CODE	Description	Unit	1+
SFR195LUN	Lunch Box	1	<b>4.50</b>

## Seal Fresh Pizza Storer



- Complete with air-tight lids.
- Microwave, freezer and dishwasher safe.
- 75mm(H) x 250mm(W) x 250mm(D).

CODE	Description	Unit	1+
SFR250PZA	Pizza Storer	1	<b>10.00</b>

## Seal Fresh Meat & Poultry Storer



- Complete with air-tight lids.
- Microwave, freezer and dishwasher safe.
- 140mm(H) x 210mm(W) x 300mm(D).

CODE	Description	Unit	1+
SFR300FMP	Meat & Poultry Storer	1	<b>11.75</b>

## Seal Fresh Square Cake Storer



- Complete with air-tight lids.
- Microwave, freezer and dishwasher safe.
- 125mm(H) x 260mm(W) x 260mm(D).

CODE	Description	Unit	1+
SFR262CAK	Square Cake Storer	1	<b>11.75</b>

## Seal Fresh Giant Storer



- Complete with air-tight lids.
- Microwave, freezer and dishwasher safe.
- 160mm(H) x 315mm(W) x 315mm(D).

CODE	Description	Unit	1+
SFR315GNT	Giant Storer	1	<b>14.50</b>

## Seal Fresh Small Vegetable Storer



- Complete with air-tight lids.
- Microwave, freezer and dishwasher safe.
- 130mm(L) x 130mm(W) x 140mm(H).

CODE	Description	Unit	1+
SFR135VEG	Small Vegetable Storer	1	<b>6.75</b>

## Seal Fresh Dessert Storer



- Complete with air-tight lids.
- Microwave, freezer and dishwasher safe.
- 100mm(H) x 110mm(W) x 110mm(D).

CODE	Description	Unit	1+
SFR110FDS	Dessert Storer	1	<b>4.50</b>

## Seal Fresh Cereal Dispenser



- Complete with air-tight lids.
- Microwave, freezer and dishwasher safe.
- 230mm(H) x 100mm(W) x 230mm(D).

CODE	Description	Unit	1+
SFR230CER	Cereal Dispenser	1	<b>10.00</b>

## Klip It Storage Containers Pack of 6



- Rubberised seal and locking clip that keeps food fresh
- Twin clip action to open and close.
- Freezer, dishwasher and microwave safe.
- Contents: 1 x 2 litre, 1 x 1 litre, 2 x 400ml, 2 x 200ml storage containers.
- Overall dimensions: 235mm x 170mm x 160mm.

CODE	Description	Unit	1+
KLP600PAK	Klip It Storage Containers	Pack of 6	<b>18.00</b>

## Pastry Brush



- Wooden handle.
- 25mm (w), 45mm bristles.

CODE	Description	Unit	1+
BRU100PST	Pastry Brush	1	4.50

## Silicone Pastry Brush



- Dishwasher safe.
- Heat resistant up to 260°C.

CODE	Description	Unit	1+
BRU020SLC	Silicone Pastry Brush	1	5.50

## Rolling Pin



- 18" long.
- Wooden construction.

CODE	Description	Unit	1+
RPN180WDN	Rolling Pin	1	11.25

## Spatula



- 10" long.
- Dishwasher safe.
- Strong hygienic handle with flexible head.

CODE	Description	Unit	1+
SPT026RUB	Spatula	1	2.50

## Wooden Spoon



- 10" long.

CODE	Description	Unit	1+
WDS100STD	Wooden Spoon	1	2.25

## Wire Whisk



- Strong, 12 wire stainless steel hand-whisk with seamless handle.
- 250mm/10" long.

CODE	Description	Unit	1+
WHK130PLH	Wire Whisk	1	5.50

## Pyrex Bowl



- Suitable for conventional ovens, microwaves, storing in fridges and serving.
- 3.0ltr capacity.
- Dishwasher safe.

CODE	Description	Unit	1+
BWL300PYR	Pyrex Bowl	1	14.50

## Graduated Measuring Jug



- Microwave safe polypropylene.
- 2.2 litre capacity.

CODE	Description	Unit	1+
JUG220PLP	Measuring Jug	1	8.50

## Measuring Spoons



- Set of four stainless steel measuring spoons.
- Contents: 1 tbsp (15ml), 1 tsp (5ml), ½ tsp (2.5ml) and ¼ tsp (1.25ml).

CODE	Description	Unit	1+
MSP155SST	Measuring Spoons	1	8.75

## Weighstation Small Digital Platform Scale



- Hygienic and easy to clean electronic scales with removable weighing platform.
- Battery or mains powered. (Supplied with mains power adaptor. 4 x D batteries are required for battery operation.)
- Removable platform for easy cleaning.
- Wipe clean splash proof fascia.
- Clear digital display.
- Capacity: 3kg/6lb, Graduation: 0.5g/0.025oz.
- Platform size: 180mm x 180mm.
- Overall dimensions: 80mm(H) x 178mm(W) x 225mm(D).

CODE	Description	Unit	1+
SCL300DGT	Digital Platform Scale	1	101.25

## Big Digit Timer



- Big screen display countdown timer with 12 or 24 hour display.
- Maximum countdown up to 99 hours, 59 minutes and 59 seconds. Requires 1 x AAA battery (supplied).
- Dimensions : 80mm(H) x 80mm(W) x 25mm(D).

CODE	Description	Unit	1+
TMR350DGT	Big Digit Timer	1	9.00

## Can Opener



- Bottle opening facility

CODE	Description	Unit	1+
COP150HDG	Can Opener	1	<b>16.75</b>

## Ice Cream Scoop



- Liquid filled to transmit heat from hand to scoop.

CODE	Description	Unit	1+
ICS010TRD	Ice Cream Scoop	1	<b>10.00</b>

## Pasta Machine



- Chrome-plated steel construction with nickel-plated rollers that produce dough in various thicknesses and two widths.
- Ravioli cutter fits on simply for perfect results.
- Motor attachment allows for fast and simple production with a minimum of effort.
- Dimensions: 146mm(H) x 205mm(W) x 205(D)mm.
- Supplied with 2mm and 6.5mm cutters.
- Clamp included.

CODE	Description	Unit	1+
PAS150MCH	Pasta Machine	1	<b>39.25</b>

## Aluminium Garlic Press



- Robust hand operated press ideal for crushing cloves of garlic.

CODE	Description	Unit	1+
GLP160ALU	Garlic Press	1	<b>7.25</b>

## Box Grater



- Stainless steel box grater with ABS handle.
- 230mm/9".

CODE	Description	Unit	1+
BXG900MTL	Box Grater 230mm / 9"	1	<b>7.25</b>

## Black Plastic Tongs



CODE	Description	Unit	1+
TNG230BLK	Plastic Tongs 230mm	1	<b>4.00</b>

## Pestle & Mortar



- White porcelain pestle and mortar.
- 4.5" diameter.

CODE	Description	Unit	1+
PAM450PCL	Porcelain Pestle & Mortar	1	<b>28.00</b>

## Clear Funnel



- 150mm diameter.

CODE	Description	Unit	1+
FUN150CLR	Funnel Clear	1	<b>2.00</b>

## Serrated Scissors 7"



CODE	Description	Unit	1+
SCS700SER	Serrated Scissors 7"	1	<b>6.25</b>

## Juice Extractor



- 95mm diameter x 80mm high.

CODE	Description	Unit	1+
JUC095EXT	Juice Extractor	1	<b>4.75</b>

## Vegetable Peeler



- Traditional peeler with handle and double sided blade.

CODE	Description	Unit	1+
PLR110BLK	Plastic Peeler	1	<b>3.00</b>

We're currently expanding our **Food Technology** range, so please contact us with your requirements.

## Potato Masher



- Tinned wire head with nylon handle.
- Round base, 5" diameter.

CODE	Description	Unit	1+
PMS500RND	Potato Masher	1	<b>31.50</b>

## Sifter / Dredger



- Stainless steel.
- 1mm holes.

CODE	Description	Unit	1+
DRE200SST	Sifter / Dredger	1	<b>10.75</b>

## Starter Knife Set 7 Piece



- Set includes 10½" cook's knife and wallet.

CODE	Description	Unit	1+
KNF700SET	Starter Knife Set	1	<b>73.00</b>

## Fish/Egg Slice



- Stainless steel with hook handle.
- 90mm x 115mm.

CODE	Description	Unit	1+
FSL114MTL	Fish/Egg Slice	1	<b>7.75</b>

## Insertion Thermometer



- LCD insertion thermometer with sleeve.
- Temperature range - 50 to +150°C.

CODE	Description	Unit	1+
THR050MMT	Insertion Thermometer	1	<b>21.25</b>

## Bread Knife



- Stainless steel blade and dishwasher proof handle.
- 8" blade.

CODE	Description	Unit	1+
KNF800BRD	Bread Knife	1	<b>14.50</b>

## Metal Skewer 10"

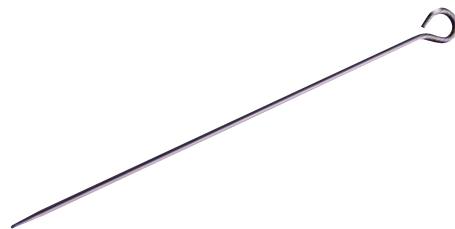

- Stainless steel.
- 10" long.

CODE	Description	Unit	1+
SKR250MTL	Metal Skewer 10"	1	<b>1.00</b>

## Butane Gas Lighter



- Gas lighter excellent for lighting hobs.

CODE	Description	Unit	1+
LGT170PEZ	Butane Gas Lighter	1	<b>10.75</b>

## Table Cutlery Stainless Steel Pack of 12



CODE	Description	Unit	1+
FRK012PAK	Forks	Pack of 12	<b>4.00</b>
KNF012PAK	Knives	Pack of 12	<b>6.25</b>
SPN012PAK	Dessert Spoons	Pack of 12	<b>3.25</b>
TSP012PAK	Teaspoons	Pack of 12	<b>2.25</b>

## Aluminium Colander



- 306mm x 188mm.

CODE	Description	Unit	1+
COL306ALU	Colander	1	<b>30.25</b>

## Sharpening Steel



- Chromed steel.
- Round, 12" long.

CODE	Description	Unit	1+
SHS120RND	Sharpening Steel	1	<b>19.00</b>

## Cutlery Tray 4 Compartment



CODE	Description	Unit	1+
TRA440CTL	Cutlery Tray	1	<b>9.75</b>



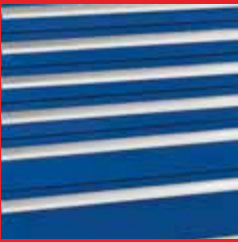

# Storage & Furniture

**Boxes & Racks**  
298-299

**Storage & Seating**  
299-305

**Lockers**  
305

**Benches**  
306-309

**Cupboards & Drawers**  
310-312

**Wall Bins & Height Adjustable Benches**  
313-314

**Metal Benches & Hop-ups**  
315

**Access Equipment**  
316



## Polymer Toolboxes



- Functional, robust and impact resistant.
- Integral parts organisers.
- Lift out tote tray.

CODE	Size	Unit	12+	4+	1+
TBX335WTT	335mm/13"	1	7.25	7.95	8.95
TBX415WTT	415mm/16"	1	12.75	13.75	15.50

## Stanley Toolbox



- Functional and robust toolbox having a strong metal catch.
- Tote tray and parts organiser.

CODE	Size	Unit	10+	4+	1+
STA160TBX	16"	1	12.75	13.75	15.50
STA190TBX	19"	1	18.95	19.95	22.95

## Stanley Heavy Duty Wheeled Toolbox



- Easy transportation and storage for larger tools and workshop materials.
- Extra-large nickel plated metal latches.
- Removable tote tray.
- Heavy-duty wheels.
- Dimensions: 603 x 375 x 430mm.

CODE	Description	Unit	4+	1+
STA192902	Mobile Toolbox	1	54.00	56.25

## Metal Barn Toolbox



- Made from heavy-gauge sheet steel with a durable powder coated finish.
- Fitted with a sturdy carry handle and clip style lock which accommodates a padlock for added security.
- 16"/420mm is a plain barn box (lift out tray NOT included).
- 19"/480mm benefits from additional tote tray.

CODE	Size	Unit	4+	1+
TBX160BAR	16"/420mm	1	19.95	21.75
TBX190BAR	19"/480mm	1	25.95	27.25

## Heavy Duty Tool Bag



- Hard-wearing reinforced material is stitched with internal seams for maximum strength and durability and is fitted with a lockable tough nylon zip fastener.
- Made from heavy duty water-resistant canvas.
- Reinforced handles attached to straps extending under bag for maximum strength
- Base has studs fastened through internal baseboard
- Size: 18in.

CODE	Description	Unit	4+	1+
KAN18HDTB	Toolbag	1	22.95	24.75

## Storage Box Organiser 380mm



- Robust case with hinged clear lid and integral carrying handle.
- 22 section storage with dividers
- 380 x 310 x 60mm.

CODE	Description	Unit	3+	1+
SBX380PLS	380mm	1	7.75	8.50

## Wood Rack Storage System



- Ideal for workshops providing generous storage for timber, pipes etc.
- 6 levels of storage hold 50kg (110lb) of material per level with a storage width of 12"/305mm
- Robust powder-coated steel tubing for internal and external use.

CODE	Description	Unit	4+	1+
SSY650WRK	Wood Rack System	1	55.75	59.25

## Raaco Cabinet



- Steel frame and 44 impact-resistant transparent drawers.
- Ideal for small parts and tool storage
- Overall size: 510 x 307 x 146mm.

CODE	Description	Unit	2+	1+
RAA045CAB	Cabinet	1	33.75	37.00

## Folding Crate



- Tough construction.
- Folds flat when not in use.
- Black Colour.
- Dimensions (Unfolded) - External: 470 x 342 x 234, Internal: 443 x 315 x 225 (length x width x depth in mm).
- Weight 945g.

CODE	Description	Unit	10+	4+	1+
FDC032BLK	32 litre	1	6.75	7.00	9.00

Horizontal Bar Rack Single Sided



- Maximum load 500kg per level.
- Six storage levels on single sided units.
- Starter bay 2 uprights and cross bracing.
- Extension bay 1 upright and cross bracing.
- Starter bay 1880(H) x 860(D) x 2445mm(L), weight 100kg.
- Extension bay 1880(H) x 860(D) x 2010mm(L), weight 53kg.

CODE	Description	Unit	1+
RAK101SRS	Single Sided Starter Bay	1	895.00
RAK102SRE	Single Sided Extension Bay	1	550.00

Vertical Bar Rack



- Fully welded steel construction with steel base.
- 600 x 250mm storage bays.
- Predrilled for bolting to floor, fixings not supplied.
- Finish is blue epoxy.

CODE	Bays H x D x L mm	Weight	Unit	1+
RAK400VBR	4 1500 x 600 x 1200	84kg	1	425.00
RAK600VBR	6 1500 x 600 x 1800	108kg	1	495.00
RAK800VBR	8 1500 x 600 x 2400	135kg	1	650.00

High Capacity Storage Cupboard



Storage

Horizontal Bar Rack Double Sided

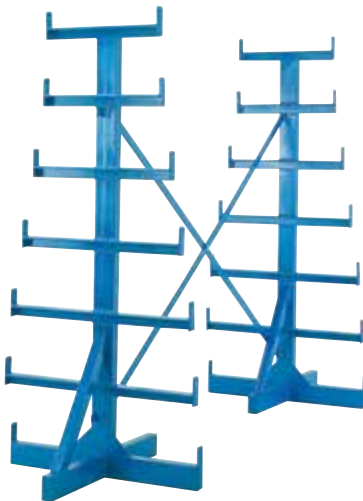

- Maximum load 1000kg per level.
- Seven levels on double sided units.
- Starter bay 2 uprights and cross bracing.
- Extension bay 1 upright and cross bracing.
- Starter bay 1985(H) x 920(D) x 2445mm(L), weight 128kg.
- Extension bay 1985(H) x 920(D) x 2010mm(L), weight 68kg.

CODE	Description	Unit	1+
RAK201DRS	Double Sided Starter Bay	1	1150.00
RAK202DRE	Double Sided Extension Bay	1	595.00

Multi-Height Sheet Rack



- Ideal for off-cuts and other variable sizes of sheet and plate.
- Support bar heights: 400; 550; 700; 850 and 1000mm.
- Distance between bars: 160mm. Fitted with sheet steel base.
- Predrilled for floor fixing.
- Finish is blue epoxy.

CODE	H x D x L mm	Weight	Unit	1+
RAK140MSR	1000 x 800 x 1400	75kg	1	395.00

PLEASE NOTE:

The product above is made up from 2 components - an Empty Cupboard, plus a Trays and Runners Pack of your choice.

Empty High Capacity Storage Cupboard

- High density secure storage solution.
- 3 point locking reinforced doors.
- 1830 x 1120 x 457mm.

CODE	Description	Unit	1+
CAB521EMP	High Cap.	1	525.00

Trays and Runners Packs for High Capacity Cupboard

- Trays and Runners for High Capacity Cupboard.
- Part of CAB521EMP.

CODE	Description	Unit	1+
CAB521PK1	Extra Deep Blue Trays	Pack of 18	255.00
CAB521PK2	Deep Blue Trays	Pack of 27	325.00
CAB521PK3	Shallow Blue Trays	Pack of 51	500.00
CAB521PK4	Extra Deep Red trays	Pack of 18	255.00
CAB521PK5	Deep Red Trays	Pack of 27	325.00
CAB521PK6	Shallow Red Trays	Pack of 51	500.00

Storage

## Small Parts Storage Cupboard



- Robust reinforced double door steel cabinet.
- The entire back is a louvre panel to suit Wall Bins.
- Secure 3-point locking.
- Supplied empty or complete with a selection of 60 Wall Bins.

H1830 x W915 x D457mm

CODE	Description	Unit	1+
CAB060SPS	Complete	1	<b>1095.95</b>
CAB183SPS	Empty	1	<b>653.95</b>

## Wall Bins

See page 295 separate bins.



## Combi Storage Cupboard



30 Trays



18 Trays



12 Trays

### PLEASE NOTE:

The product above is made up from 2 components - an **Empty Combi Cupboard**, plus a **Trays and Runners Pack** of your choice.

## Empty Combi Storage Cupboard

- High density secure storage with 2 shelves.
- 3 point locking reinforced doors.
- 1830 x 1120 x 457mm.

CODE	Description	Unit	1+
CAB311EMP	Combi	1	<b>525.00</b>

## Trays and Runners Pack for Combi Storage Cupboard

- Trays and Runners for High Capacity Cupboard.
- Part of CAB311EMP.

CODE	Description	Unit	1+
CAB311PK1	Extra Deep Blue	Pack of 12	<b>170.00</b>
CAB311PK2	Extra Deep Red	Pack of 12	<b>170.00</b>
CAB311PK3	Deep Blue	Pack of 18	<b>215.00</b>
CAB311PK4	Deep Red	Pack of 18	<b>215.00</b>
CAB311PK5	Shallow Blue	Pack of 30	<b>300.00</b>
CAB311PK6	Shallow Red Trays	Pack of 30	<b>300.00</b>

## Standard Cupboard Large



- Welded frame design for extra strength
- Three point security locking
- Anti-bacterial powder coated.
- Supplied with three adjustable shelves.

CODE	Size (mm)	Unit	1+
CAB189LGC	1830 x 915 x 457	1	<b>472.50</b>

## Janitorial Cupboard Large



- Welded frame design for extra strength
- Three point security locking
- Anti-bacterial powder coated.
- Supplied with four half width shelves.

CODE	Size (mm)	Unit	1+
CAB189JAN	1830 x 915 x 457	1	<b>525.50</b>

## Standard Cupboard Extra Wide & Janitorial Cupboard Extra Wide



- Welded frame design for extra strength
- Three point security locking
- Anti-bacterial powder coated.
- Standard: Supplied with three adjustable shelves.
- Janitorial: Supplied with three half width adjustable shelves and full height compartment.

CODE	Description	Size (mm)	Unit	1+
CAB181EWC	Standard	1830 x 1220 x 457	1	<b>634.95</b>
CAB181JAN	Janitorial	1830 x 1220 x 457	1	<b>720.25</b>

**Gratnells Complete Unit**  
12 Tray Under Bench Height



- Complete units, supplied with trays, runners and adjustable feet.
- Supplied flat packed.
- 12 blue shallow trays.

**H725 x W710 x D420mm**

CODE	Description	Unit	1+
GTN712CSU	12 Tray	1	<b>295.00</b>

**Gratnells Complete Unit**  
21 Tray Bench Height



- Complete units, supplied with trays, runners and adjustable feet.
- Supplied flat packed.
- 21 blue shallow trays.

**H825 x W1055 x D420mm**

CODE	Description	Unit	1+
GTN821CSU	21 Tray	1	<b>415.00</b>

**Gratstack Single**  
6 Shallow Trays



- Highly durable polymer click-together frame system.
- Sturdy and easy to assemble.
- 6 shallow trays.

**H694 x W354 x D430mm**

CODE	Description	Unit	1+
GTN600GTS	6 Tray	1	<b>95.00</b>

**Gratnells Complete Unit**  
18 Tray Under Bench Height



- Complete units, supplied with trays, runners top and adjustable feet.
- Supplied flat packed.
- 18 blue shallow trays.

**H725 x W1055 x D420mm**

CODE	Description	Unit	1+
GTN718CSU	18 Tray	1	<b>375.00</b>

**Gratnells Complete Unit**  
51 Tray Tall Frame



- Complete units, supplied with trays, runners and adjustable feet.
- Supplied flat packed.
- 51 blue shallow trays.

**H1850 x W1055 x D420mm**

CODE	Description	Unit	1+
GTN151CSU	51 Tray	1	<b>895.00</b>

**Gratstack Single**  
3 Deep Trays



- Highly durable polymer click-together frame system.
- Sturdy and easy to assemble.
- 3 deep trays.

**H583 x W354 x D430mm**

CODE	Description	Unit	1+
GTN300GTS	3 Tray	1	<b>85.00</b>

**Gratnells Complete Unit**  
14 Tray Bench Height



- Complete units, supplied with trays, runners and adjustable feet.
- Supplied flat packed.
- 14 blue shallow trays.

**H825 x W710 x D420mm**

CODE	Description	Unit	1+
GTN814CSU	14 Tray	1	<b>315.00</b>

**Gratstack Single**  
2 Shallow and 2 Deep Trays



- Highly durable polymer click-together frame system.
- Sturdy and easy to assemble.
- 2 shallow and 2 deep trays.

**H620 x W554 x D430mm**

CODE	Description	Unit	1+
GTN400GTS	4 Tray	1	<b>87.50</b>

## Gratnells Shallow Tray



- The educational storage tray system designed to fit 450mm deep furniture.
- Supplied in a wide range of colours.
- Durable polypropylene, BSI tested.

### H75 x W312 x D427mm

CODE	Description	Unit	6+	3+	1+
GTN101SBU	Blue	1	<b>3.95</b>	4.25	4.30
GTN102SRD	Red	1	<b>3.95</b>	4.25	4.30
GTN103SYL	Yellow	1	<b>3.95</b>	4.25	4.30
GTN104SPU	Purple	1	<b>3.95</b>	4.25	4.30
GTN105SGR	Green	1	<b>3.95</b>	4.25	4.30
GTN106STR	Translucent	1	<b>3.95</b>	4.25	4.30

## Gratnells Deep Tray



- The educational storage tray system designed to fit 450mm deep furniture.
- Supplied in a wide range of colours.
- Durable polypropylene, BSI tested.

### H150 x W312 x D427mm

CODE	Description	Unit	6+	3+	1+
GTN201DBU	Blue	1	<b>5.95</b>	6.25	6.30
GTN202DRD	Red	1	<b>5.95</b>	6.25	6.30
GTN203DYL	Yellow	1	<b>5.95</b>	6.25	6.30
GTN204DPU	Purple	1	<b>5.95</b>	6.25	6.30
GTN205DGR	Green	1	<b>5.95</b>	6.25	6.30
GTN206DTR	Translucent	1	<b>5.95</b>	6.25	6.30

## Gratnells Deep Tray



- The educational storage tray system designed to fit 450mm deep furniture.
- Supplied in a wide range of colours.
- Durable polypropylene, BSI tested.

### H225mm x W312 x D430

CODE	Description	Unit	6+	3+	1+
GTN251EBU	Blue	1	<b>6.95</b>	7.50	8.50
GTN252ERD	Red	1	<b>6.95</b>	7.50	8.50
GTN256ETR	Translucent	1	<b>6.95</b>	7.50	8.50

## Gratnells Foam Tray Insert



- These foam inserts are designed to be used in conjunction with the shallow and deep trays.
- Pre-cut foam inserts to hold delicate object safely.
- Designed for 30 calculators or 30 pairs of glasses.

### H50 x W265 x D385mm

CODE	Description	Unit	6+	1+
GTN301CAL	30 x Calculator	1	<b>5.25</b>	5.50
GTN302GLS	30 x Glasses	1	<b>5.25</b>	5.50

**Gratnells Trolley Unit**  
Single Column 6 Shallow Trays



- Robust mobile trolleys.
- Steel flat packed frame in silver.
- 75mm castors with 2 braked, plus optional feet.
- 6 blue shallow trays.

H715 x W370 x D420mm

CODE	Description	Unit	1+
GTN106TLY	6 Tray	1	<b>235.00</b>

**Gratnells Trolley Unit**  
Double Column 16 Shallow Trays



- Robust mobile trolleys.
- Steel flat packed frame in silver.
- 75mm castors with 2 braked, plus optional feet.
- 16 blue shallow trays.

H850 x W710 x D420mm

CODE	Description	Unit	1+
GTN216TLY	16 Tray	1	<b>365.00</b>

**Gratnells Trolley Unit**  
Treble Column 12 Deep Trays



- Robust mobile trolleys.
- Steel flat packed frame in silver.
- 75mm castors with 2 braked, plus optional feet.
- 12 blue deep trays.

H850 x W1054 x D420mm

CODE	Description	Unit	1+
GTN312TLY	12 Deep	1	<b>395.00</b>

**Gratnells Trolley Unit**  
Double Column 12 Shallow Trays



- Robust mobile trolleys.
- Steel flat packed frame in silver.
- 75mm castors with 2 braked, plus optional feet.
- 12 blue shallow trays.

H715 x W710 x D420mm

CODE	Description	Unit	1+
GTN212TLY	12 Tray	1	<b>285.00</b>

**Gratnells Trolley Unit**  
Treble Column 24 Shallow Trays



- Robust mobile trolleys.
- Steel flat packed frame in silver.
- 75mm castors with 2 braked, plus optional feet.
- 24 blue shallow trays.

H850 x W1054 x D420mm

CODE	Description	Unit	1+
GTN324TLY	24 Tray	1	<b>440.00</b>

**Gratnells Callero**  
A3 Paper Trolley



- Perfect for storing large sheets of paper and similar materials.
- Includes 6 blue extra wide trays.
- Fitted with welded runners and includes braked castors.

H947 x W500 x D500

CODE	Description	Unit	1+
GTN603CPT	Paper Trolley	1	<b>305.00</b>

**Gratnells Trolley Unit**  
Treble Column 18 Shallow Trays



- Robust mobile trolleys.
- Steel flat packed frame in silver.
- 75mm castors with 2 braked, plus optional feet.
- 18 blue shallow trays.

H715 x W1054 x D420mm

CODE	Description	Unit	1+
GTN318TLY	18 Tray	1	<b>385.00</b>

**Gratnells Trolley Unit**  
Double Column 8 Deep Trays



- Robust mobile trolleys.
- Steel flat packed frame in silver.
- 75mm castors with 2 braked, plus optional feet.
- 8 blue deep trays.

H850 x W710 x D420mm

CODE	Description	Unit	1+
GTN208TLY	8 Deep	1	<b>315.00</b>

**Gratnells Callero Art Trolley**



- A combo version which includes 5 extra wide drawers and 10 white wire drying racks.
- Recessed top provides additional storage area.
- Fitted with welded runners and includes braked castors.

H947 x W570 x D500mm

CODE	Description	Unit	1+
GTN153CAT	Art Trolley	1	<b>695.00</b>

Storage

## Gratnells Callero Tilted Tray Storage Unit



- Treble width unit supplied with 9 deep trays, supported on tilt position crossbars for open storage.
- Supplied with feet and braked castors.
- Includes 9 blue deep trays.

**H1025 x W1020 x D430mm**

CODE	Description	Unit	1+
GTN102TTS	Tilted Unit	1	<b>395.00</b>

## Gratnells MakerSpace Trolley



*Tools not included*

- The latest addition to Gratnells successful Callero family of specialist school storage.
- Gratnells trays have also become the system of choice for many STEM and STEAM kit manufacturers, and again these will fit directly into the MakerSpace trolley.
- Can be used as a standalone workstation, having ample storage for materials and hand tools.
- Complete with 3 deep trays, 12 shallow trays, 9 green wall bins, 5 x 75mm double hooks 5 x 50mm single hooks and metal tape holder.

**H 1565 x W 1025 x D 430mm Fully assembled**

CODE	Description	Unit	1+
GTN240MST	MakerSpace	1	<b>780.00</b>

## Gratnells Moulded Tray Insert



- These rigid plastic inserts are designed to be used in conjunction with the shallow tray.
- Vacuum formed grey polystyrene.

**H40 x W275 x D388mm**

CODE	Description	Unit	6+	1+
GTN300MTR	Three Section	1	<b>4.75</b>	4.95
GTN400MTR	Four Section	1	<b>4.75</b>	4.95

## Gratnells G3 Drawer Runners Grey Pair Pack of 6 or 51



- Standard metal runner for use in Gratnells range of cabinets, frames and trolleys.

**H30 x W15 x L402mm**

CODE	Description	Unit	1+
GTN306RUN	Grey Pair	Pack of 6	<b>39.95</b>
GTN351RUN	Grey Pair	Pack of 51	<b>295.00</b>

## Gratnells Drawer Runners Pair



- Gratnells standard runner for wood furniture.
- White colour polypropylene.

**H35 x W16 x L347mm**

CODE	Description	Unit	12+	4+	1+
GTN502RUN	P5 Runner	Pair	<b>2.95</b>	3.25	3.50



If you require any **Gratnells Products or Parts**, please contact us.

## Hazardous Substance Cabinet

- Hazardous Substance Cabinets (Yellow) labelled 'Flammable' and 'Flammable Liquid'.
- Supplied with one shelf except the 1830mm high which has 3 shelves.
- Each unit has a sump area in the base.



CODE	Size (mm)	Sump Capacity	Unit	1+
CAB189HAZ	1830 x 915 x 457	36 Litres	1	<b>580.25</b>
CAB109HAZ	1000 x 915 x 457	30 Litres	1	<b>401.95</b>
CAB079HAZ	710 x 915 x 457	30 Litres	1	<b>363.25</b>
CAB074HAZ	710 x 457 x 305	10 Litres	1	<b>285.50</b>
CAB044HAZ	457 x 457 x 305	5 Litres	1	<b>273.25</b>

## COSHH Cabinet

- COSHH cabinets (Grey) labelled 'Harmful' and 'Irritant'.
- Supplied with one shelf except the 1830mm high which has 3 shelves.
- Each unit has a sump area in the base.



CODE	Size (mm)	Number of Shelves	Sump Capacity	Unit	1+
CAB189CSH	1830 x 915 x 457	3	36 Litres	1	<b>618.95</b>
CAB109CSH	1000 x 915 x 457	1	30 Litres	1	<b>431.50</b>



Mesh Lockers



LKR124MSH 12 Compartments



LKR164MSH 16 Compartments



LKR204MSH 20 Compartments

- Multiple mesh lockers with either 12, 16 or 20 compartments.
- Bright zinc plating with individual pad-lockable doors.
- Ideal storage for items containing moisture.
- Compartment size 305 x 305 x 405mm deep.

H1305 x W305 x D450mm

CODE	Compartments / Size	Unit	1+
LKR124MSH	12 / 1360 x 915 x 450mm	1	<b>350.00</b>
LKR164MSH	16 / 1360 x 1220 x 450mm	1	<b>395.00</b>
LKR204MSH	20 / 1360 x 1525 x 450mm	1	<b>525.00</b>

Bench Seating



BNS150STD Bench



BNS151SSC Single-sided with coat hooks



BNS152DSC Double-sided with coat hooks

- Welded 38mm tubular steel.
- Beech wood slats.
- Available as a plain bench, single or double island unit with coat hooks (wire shoe racks are an extra).
- Compartment size 305mm square.

W1500mm

CODE	Size	Type	Unit	2+	1+
BNS150STD	H390 x D300mm	Bench	1	<b>242.95</b>	<b>262.75</b>
BNS151SSC	H1800 x D400mm	Single	1	<b>381.75</b>	<b>412.75</b>
BNS152DSC	H1800 x D760mm	Double	1	<b>630.75</b>	<b>681.95</b>

Four Door Locker



These four door lockers have proved to be the most popular design for schools and colleges and are available in single, nest of two or three. Other door configurations, colours and locking mechanism our available - please contact us..

- Robust steel construction.
- Welded frame design.
- Anti-bacterial coated.

H1800 x D450mm

CODE	Description	Width	Unit	1+
LKR441BLU	Single	300mm	1	<b>229.25</b>
LKR442BLU	Nest of 2	600mm	1	<b>454.25</b>

Clean & Dirty Locker



H1800 x W450 x D450mm

CODE	Description	Unit	1+
LKR044BCD	Clean & Dirty Locker	1	<b>222.50</b>

Benches

## EduBench Systems Four Station Bench



- The accurately cut recess allows the fixed jaw of the vice to run flush with the bench edge – ideal for clamping long workpieces rigidly.
- Maximum of four vices per bench.
- All benches are pre-cut to accept the 7" Woodworking vice on each side of the bench top. The vice blocks and timber faces are supplied with the bench.
- The central tool well is reversible providing a totally flat work surface.
- Size: 4ft sq.
- Supplied flat packed

**EduBench**  
SYSTEMS

1200 x 1200 x 840mm

CODE	Description	Unit	8+	4+	1+
EBS404BSC	Four Station Bench	1	595.00	625.00	675.00

## EduBench Systems Traditional 4 Station Bench with Vices



- Traditional 40mm beech top with central well and vice recesses.
- Beech leg frame.
- Available with either four professional plain screw or quick release 7" woodworking vices.
- Supplied flat packed.

**EduBench**  
SYSTEMS

1200 x 1200 x 840mm

CODE	Description	Unit	8+	4+	1+
EBS404VPS	Plain	1	799.00	850.00	925.00
EBS404VQR	Quick-release	1	850.00	895.00	975.00

## EduBench Systems Metal Leg Frame Adjustable Height



- Strong metal frame with adjustable legs.
- 3 height adjustments of 810mm, 860mm and 910mm.
- Suits any 1200 x 1200mm top.

**EduBench**  
SYSTEMS

CODE	Description	Unit	8+	4+	1+
EBS910MLF	Metal Adj Frame	1	295.00	325.00	350.00

- Available with either a phenolic faced plywood for a practical and durable surface or a solid beech top.

**EduBench**  
SYSTEMS

1200 x 1200 x 850/900/950mm

CODE	Description	Unit	8+	4+	1+
EBS910MUT	Multi-use	1	445.00	460.00	495.00
EBS910BEC	Beech	1	650.00	695.00	745.00

## EduBench Systems Double Cupboard Unit



- This double cupboard is designed to sit beneath the bench and mounts on the cross frame.
- The two doors open at 90° to each other.
- By mounting two of these units to a bench, each work station has its own storage cupboard.
- Maximum of two units per bench.

**EduBench**  
SYSTEMS

850 x 425 x 500mm

CODE	Description	Unit	8+	4+	1+
EBS200DUC	Cupboard Unit	1	185.00	190.00	199.00

## EduBench Systems Double Cupboard Unit



- Traditional 40mm beech top with central well and vice recesses
- Beech leg frame with four cupboards.
- Available with either four professional plain screw or quick release 7" woodworking vices.
- Supplied flat packed.

**EduBench**  
SYSTEMS

1200 x 1200 x 840mm

CODE	Description	Unit	8+	4+	1+
EBS424VPS	Plain	1	1095.00	1195.00	1295.00
EBS424VQR	Quick-release	1	1150.00	1250.00	1350.00

## EduBench Systems Traditional 4 Station Bench with Adjustable Legs and Vices



- Strong metal frame with adjustable legs.
- 3 height adjustments of 810mm, 860mm and 910mm.
- Traditional 40mm beech top with central well and vice recesses.
- Available with either four professional plain screw or quick release 7" woodworking vices.

**EduBench**  
SYSTEMS

CODE	Description	Unit	8+	4+	1+
EBS910VPS	Plain	1	875.00	935.00	995.00
EBS910VQR	Quick-release	1	915.00	975.00	1045.00

SEE WORKHOLDING

## Woodworking Vices



**EduBench Systems  
Traditional 4 Station, Metal Frame  
with plain screw vices**



- Traditional 40mm beech top with vices recesses.
- Central well is reversible to give a flat surface.
- Large steel tubular leg frame, with adjustable feet for levelling.
- Includes four - WWW700PSR 7 "Plain Screw Vices.

1200 x 1200 x 890mm

**EduBench**  
SYSTEMS

CODE	Description	Unit	8+	4+	1+
EBS431TMP	431	1	<b>895.00</b>	990.00	1060.00

**EduBench Systems  
Traditional 4 Station, Metal Frame  
with plain screw vices and  
cupboards**



- Traditional 40mm beech top with vices recesses.
- Central well is reversible to give a flat surface.
- Large steel tubular leg frame, with adjustable feet for levelling.
- Includes four - WWW700PSR 7" Plain Screw Vices and under cupboards.

1200 x 1200 x 890mm

**EduBench**  
SYSTEMS

CODE	Description	Unit	8+	4+	1+
EBS432TPC	432	1	<b>1275.00</b>	1350.00	1450.00

**EduBench Systems  
Hexagonal 6 Station, Metal Frame  
with plain screw vices**



- Traditional 40mm beech top with vices recesses.
- Central well is reversible to give a flat surface.
- Large steel tubular leg frame, with adjustable feet for levelling.
- Includes six - WWW700PSR 7" Plain Screw Vices.

1800 x 890mm

**EduBench**  
SYSTEMS

CODE	Description	Unit	8+	4+	1+
EBS661HMP	661	1	<b>1795.00</b>	1990.00	2175.00

**EduBench Systems  
Traditional 4 Station, Metal Frame  
with Q/R vices**



- Traditional 40mm beech top with vices recesses.
- Central well is reversible to give a flat surface.
- Large steel tubular leg frame, with adjustable feet for levelling.
- Includes four - WWW700PSR 7" Quick Release Vices.

1200 x 1200 x 890mm

**EduBench**  
SYSTEMS

CODE	Description	Unit	8+	4+	1+
EBS433TMQ	433	1	<b>950.00</b>	1025.00	1125.00

**EduBench Systems  
Traditional 4 Station, Metal Frame  
with Q/R vices and  
cupboards**



- Traditional 40mm beech top with vices recesses.
- Central well is reversible to give a flat surface.
- Large steel tubular leg frame, with adjustable feet for levelling.
- Includes four - WWW700PSR 7" Quick Release Vices and under cupboards.

1200 x 1200 x 890mm

**EduBench**  
SYSTEMS

CODE	Description	Unit	8+	4+	1+
EBS434TQC	434	1	<b>1325.00</b>	1425.00	1525.00

**EduBench Systems  
Hexagonal 6 Station, Metal Frame  
with Q/R vices**



- Traditional 40mm beech top with vices recesses.
- Central well is reversible to give a flat surface.
- Large steel tubular leg frame, with adjustable feet for levelling.
- Includes six - WWW700PSR 7" Plain Screw Vices.

1800 x 890mm

**EduBench**  
SYSTEMS

CODE	Description	Unit	8+	4+	1+
EBS663HMQ	662	1	<b>1850.00</b>	2070.00	2250.00

Benches

## Edubench Systems Beech 4 Station, Metal Frame



441



442

- Solid 40mm beech top.
- Large steel tubular leg frame, with adjustable feet for levelling.

**EduBench**  
SYSTEMS

CODE	Description	Unit	8+	4+	1+
EBS441BMF	441	1	570.00	620.00	675.00
EBS442BMC	442	1	940.00	995.00	1070.00

## Edubench Systems Beech 4 Station, Metal Frame with vices



443



444

- Solid 40mm beech top.
- Large steel tubular leg frame, with adjustable feet for levelling.
- Includes four ECL400MCV 4" Pro Mechanics Vices.
- EBS444BVC includes vices and under cupboards.

**EduBench**  
SYSTEMS

CODE	Description	Unit	8+	4+	1+
EBS443BMV	443	1	725.00	795.00	870.00
EBS444BVC	444	1	1095.00	1175.00	1270.00

## Edubench Systems Phenolic 4 Station, Metal Frame



451



452

- Phenolic faced 30mm plywood top.
- Large steel tubular leg frame, with adjustable feet for levelling.
- EBS452PMC includes under cupboards.

**EduBench**  
SYSTEMS

CODE	Description	Unit	8+	4+	1+
EBS451PMF	451	1	445.00	485.00	525.00
EBS452PMC	452	1	815.00	865.00	920.00

## Edubench Systems Phenolic 4 Station, Metal Frame with vices



453



454

- Phenolic faced 30mm plywood top.
- Large steel tubular leg frame, with adjustable feet for levelling.
- Includes four ECL400MCV 4" Pro Mechanics Vices.
- EBS444BVC includes vices and under cupboards.

**EduBench**  
SYSTEMS

CODE	Description	Unit	8+	4+	1+
EBS453PMV	453	1	595.00	660.00	720.00
EBS454PVC	454	1	970.00	1040.00	1120.00

## Edubench Systems Heavy Duty Metal Bench Frame



- Large steel tubular leg frame with central cross brace.
- Feet adjust for leveling.
- Suits any 1200 x 1200mm top.

Height 850mm

CODE	Description	Unit	8+	4+	1+
EBS404MBF	Metal Frame	1	295.00	325.00	350.00

## Edubench Systems Square Bench Tops



Multi-use Bench Top

- Phenolic faced plywood for a practical and durable surface.
- Patterned non-slip finish.
- Suits leg frames detailed on this page.

1200 x 1200 x 30mm

**EduBench**  
SYSTEMS

CODE	Description	Unit	8+	4+	1+
EBS120MUT	Multi-use	1	150.00	160.00	175.00

## Solid Beech Top



- Solid beech top made from staves of timber for stability.
- 1200 x 1200mm suitable for 4 stations.
- Heavy duty 40mm thickness.

**EduBench**  
SYSTEMS

CODE	Description	Unit	8+	4+	1+
EBS120BEC	Beech 1200mm	1	275.00	295.00	325.00

## Edubench Beech Replacement Bench Top



- Traditional solid beech replacement worktop for the Edubenches.
- 1200 x 1200mm suitable for 4 stations.
- Thickness: 40mm.

**EduBench**  
SYSTEMS

CODE	Description	Unit	8+	4+	1+
EBS404RTP	Beech Rep	1	365.00	380.00	399.00

### Edubench Systems College Bench



- Traditional 40mm beech top with central well and vice recesses.
- Beech leg frame.
- Available with either two professional plain screw or quick release 9" woodworking vices.
- Supplied flat packed.

1800 x 830 x 860mm

**EduBench**  
SYSTEMS

CODE	Description	Unit	8+	4+	1+
EBS600BCB	College Bench	1	<b>750.00</b>	775.00	795.00
EBS600VPS	Plain	1	<b>895.00</b>	925.00	950.00
EBS600VQR	Quick-release	1	<b>925.00</b>	950.00	995.00

### Edubench Systems College Bench with Cupboards and Vices



- Traditional beech top with central well and vice recesses.
- Beech leg frame.
- Available with either two professional plain screw or quick release 9" woodworking vices.
- Supplied flat packed.

1800 x 830 x 860mm

**EduBench**  
SYSTEMS

CODE	Description	Unit	8+	4+	1+
EBS620VPS	Plain	1	<b>1325.00</b>	1350.00	1395.00
EBS620VQR	Quick-release	1	<b>1350.00</b>	1395.00	1425.00

### Edubench Systems College Underbench Double Cupboard Unit



- For use with the College Bench. with cupboards on opposite corners.
- One double cupboard per bench.
- Sprung hinges with keyed lock.
- Sturdy beech faced plywood doors.
- Supplied flat packed.

L1340 x W700 x H480mm

**EduBench**  
SYSTEMS

CODE	Description	Unit	1+
EBS600DUC	Underbench Cupboard	1	<b>425.00</b>

### Edubench Systems 2 Station Bench Half Width



*Vices not included in the price below*

- Same design as the 4 station bench, providing 2 workstations with a threaded fixing plate for a woodworking vice or a vice plate to mount a mechanic's vice.
- Large tubular leg frame with sturdy bracing and easy under bench access for wheelchairs.
- Heavy duty welded steel frame with a grey finish with adjustable feet for levelling.
- Solid Beech Top - 1200 x 600 x 40mm.
- Bench Frame - 1112 x 512 x 810mm High.

**EduBench**  
SYSTEMS

CODE	Description	Unit	4+	4+
EBS600HBN	*Edubench Half Bench	1	<b>460.00</b>	495.00
EBS600BEC	Beech Top - Half Bench	1	<b>185.00</b>	205.00
EBS600MBF	Frame - Half Bench	1	<b>280.00</b>	295.00

### Edubench Systems Jeweller's Bench



- Steel box section leg frame for a traditional Jeweller's Bench.
- Adjustable feet for levelling.
- Fully welded construction with sturdy bracing.

900 x 600 x 40mm (solid beech top)

CODE	Dimensions mm	Unit	8+	4+	1+
EBS900JWL	Complete	1	<b>495.00</b>	535.00	
EBS900BEC	Top	1	<b>295.00</b>	335.00	
EBS900MBF	Frame	1	<b>150.00</b>	160.00	175.00

### Edubench Systems Traditional Bench Single Station



- Traditional European style bench.
- Beech construction throughout with a 30mm thick top and 90mm apron depth.
- Includes 2 wooden vices.
- Supplied flat packed.
- Weight 47kg.

**EduBench**  
SYSTEMS

1500/1700/2000 x 650 x 850mm (including vices)

CODE	Description	Unit	8+	4+	1+
EBS150TRD	1500mm	1	<b>475.00</b>	495.00	525.00
EBS170TRD	1700mm	1	<b>525.00</b>	550.00	575.00
EBS200TRD	2000mm	1	<b>575.00</b>	595.00	625.00

### Edubench Systems Traditional Two Station Bench



- Traditional European double sided bench.
- Beech construction throughout with a 30mm thick top and 90mm apron depth.
- Includes 4 wooden vices.
- Supplied flat packed.
- Weight 74kg

1540 x 1140 x 850mm (including vices)

CODE	Description	Unit	8+	4+	1+
EBS152DSB	Traditional 2	1	<b>795.00</b>	850.00	895.00

### Edubench Systems Professional Cabinetmaker's Two Station Bench



- Traditional European professional double sided bench.
- Beech construction throughout with a 30mm thick top and 120mm apron depth.
- Includes 2 standard vices and 2 tail vices.
- Supplied flat packed.
- Weight 113kg.

2320 x 1125 x 860mm (including vices)

**EduBench**  
SYSTEMS

CODE	Description	Unit	8+	4+	1+
EBS232DSB	Pro 2	1	<b>1275.00</b>	1325.00	1375.00

## Edubench Systems Steel Leg Support



- Steel tube with an electroplated satin finish and an aluminium mounting plate.
- Adjustable ABS foot (+30mm) for levelling.
- These legs can be cut down (plastic foot can be removed).

Ø 60mm x H870mm (900mm)

CODE	Description	Unit	8+	4+	1+
EBS876STC	60 x 870mm	1	18.75	21.00	23.50

## Piggyback Vice Mount



- A heavy duty beech base which is designed to accommodate an engineering vice on the top and be clamped into woodworking vice beneath.
- Solid beech construction.
- Takes either a 3" or 4" engineers vice.
- Clamps into any woodworking vice that's mounted flush with the bench top.
- Customer drills mounting holes to suit their vice.
- Turns a standard woodworking bench into a multi-craft workstation.

CODE	Description	Unit	4+	1+
PVM304TMB	Piggyback Mount	1	36.95	39.95

## Piggy Back Vice Mount Metal



- Piggyback attachment designed to be used with Mechanics Vice ECL300MCV.
- Enables a metalwork vice to be clamped into a woodworking vice for occasional use.
- Integral handle for easy lifting.
- Ideal for a multi-skills workshop.

CODE	Size	Unit	10+	4+	1+
PVM300MTL	Suits 3"	1	19.95	20.95	22.95

## Edubench Mobile System Cupboard



## Combi



## 4 Drawer



## 6 Drawer



- A range of high quality units (980mm) that can be used individually or grouped to create premium perimeter benching by simply adding a suitable worktop.
- All steel construction with central locking for security.
- Drawers have full extension precision ball race slides with a 100kg load capacity.
- Available in 600mm and 900mm widths.

### H980 x W600 x D650mm

CODE	Description	Size mm	Unit	1+
EBS621CUB	Cupboard	Mobile 600	1	433.00
EBS623CMB	Combi	Mobile 600	1	702.25
EBS624DRW	4 Drawers	Mobile 600	1	927.50
EBS626DRW	6 Drawers	Mobile 600	1	1119.50

### H980 x W900 x D650mm

CODE	Description	Size mm	Unit	1+
EBS921CUB	Cupboard	Mobile 900	1	505.75
EBS923CMB	Combi	Mobile 900	1	760.50
EBS924DRW	4 Drawers	Mobile 900	1	982.50
EBS926DRW	6 Drawers	Mobile 900	1	1188.50

**Beech Worktop**



- Prime beech 40mm staves.
- Hardwearing, dense and even grain.
- Supplied as an unfinished, square edged panel.
- Available in a wide range of lengths and widths in either 27 or 40mm thickness.

**27 x 635mm**

CODE	Size	Unit	1+
WTP462BCH	3m x 635 x 27mm	1	<b>Call for Price</b>

**40 x 635mm**

CODE	Size	Unit	1+
WTP464BCH	2m x 635 x 40mm	1	<b>Call for Price</b>
WTP364BCH	3m x 635 x 40mm	1	<b>Call for Price</b>
WTP264BCH	4m x 635 x 40mm	1	<b>Call for Price</b>

**40 x 720mm**

CODE	Size	Unit	1+
WTP274BCH	2m x 720 x 40mm	1	<b>Call for Price</b>
WTP374BCH	3m x 720 x 40mm	1	<b>Call for Price</b>
WTP474BCH	4m x 720 x 40mm	1	<b>Call for Price</b>

**40 x 960mm**

CODE	Size	Unit	1+
WTP294BCH	2m x 960 X 40mm	1	<b>Call for Price</b>
WTP394BCH	3m x 960 x 40mm	1	<b>Call for Price</b>



**Edubench Underbench System  
Cupboard**



**4 Drawer**



**Combi**



**6 Drawer**



**H825 x W600 x D650mm**

CODE	Description	Size mm	Unit	1+
EBS601CUB	Cupboard Underbench 600	600	1	<b>245.00</b>
EBS603CMB	Combi Underbench 600	600	1	<b>515.00</b>
EBS604DRW	4 Drawers Underbench 600	600	1	<b>765.00</b>
EBS606DRW	6 Drawers Underbench 600	600	1	<b>955.00</b>

**H825 x W900 x D650mm**

CODE	Description	Size mm	Unit	1+
EBS901CUB	Cupboard Underbench 900	900	1	<b>317.50</b>
EBS903CMB	Combi Underbench 900	900	1	<b>572.50</b>
EBS904DRW	4 Drawers Underbench 900	900	1	<b>795.00</b>
EBS906DRW	6 Drawers Underbench 900	900	1	<b>999.00</b>

- A range of high quality units (825mm) that can be used individually or grouped to create premium perimeter benching by simply adding a suitable worktop.
- All steel construction with central locking for security.
- Drawers have full extension precision ball race slides with a 100kg load capacity.
- Available in 600mm and 900mm widths.

## Edubench Roll'n'Park System



## 3 Drawer



## Cupboard



## Combi



## 5 Drawer



- Similar to the Mobile System but lower in height (780mm) which enables them to be parked out of the way, under a perimeter bench when not in use.
- All steel construction with central locking for security.
- Drawers have full extension precision ball race slides with a 100kg load capacity.
- Available in 600mm and 900mm widths.

### H780 x W600 x D650mm

CODE	Description	Size mm	Unit	1+
EBS641CUB	Cupboard	Roll'n'Park 600	1	<b>348.00</b>
EBS643CMB	Combi	Roll'n'Park 600	1	<b>604.00</b>
EBS644DRW	3 Drawers	Roll'n'Park 600	1	<b>726.50</b>
EBS646DRW	5 Drawers	Roll'n'Park 600	1	<b>919.50</b>

### H825 x W900 x D650mm

CODE	Description	Size mm	Unit	1+
EBS941CUB	Cupboard	Roll'n'Park 900	1	<b>412.50</b>
EBS943CMB	Combi	Roll'n'Park 900	1	<b>665.00</b>
EBS944DRW	3 Drawers	Roll'n'Park 900	1	<b>757.00</b>
EBS946DRW	5 Drawers	Roll'n'Park 900	1	<b>948.50</b>



### Edubench Tool Tray



- Metal tray with a non-slip rubber mat.
- Fits to all Edubench System Units, available in either 600mm or 900mm widths.

CODE	Size	Unit	1+
EBS600TTY	H24 x W600 x D650mm	1	<b>36.50</b>
EBS900TTY	H24 x W900 x D650mm	1	<b>52.25</b>

### Edubench Drawer Insert



- Metal drawer divider to create 6 equal sections 100mm deep.
- Available for either 600mm or 900mm units.

CODE	Size	Unit	1+
EBS606DWB	600mm	1	<b>32.75</b>
EBS906DWB	900mm	1	<b>41.25</b>

### Edubench Tool Trolley System Frame

A sample of a complete system



- Robustly constructed mobile frame designed to take either louvre or perforated panels.
- Locking swivel castors.

H1650 x W1000 x D260mm

CODE	Description	Unit	1+
EBS165TLY	Frame	1	<b>451.25</b>

### Edubench Perforated Panel



- Steel perforated panel which clips to the tool trolley frame.
- Designed to be used in conjunction with the Tool Hook Set.

H910 x W960 x D60mm

CODE	Description	Unit	1+
EBS166PER	Perforated	1	<b>88.50</b>

### Edubench Hook Set



- Clip-in tool holder system designed for the perforated board.
- A selection of 53 pieces including various single and double hooks, spring clips, numerous specific tool holders.

CODE	Description	Unit	1+
EBS530THS	Hook Set	1	<b>138.50</b>

### Edubench Louvered Panel



- Steel louvre panel which clips to the tool trolley frame.
- Designed to be used in conjunction with the Wall Bins - see page 295.

H910 x W960 x D60mm

CODE	Description	Unit	1+
EBS167LVR	Louvre	1	<b>93.50</b>

### Edubench Shelf



- Optional steel shelf for additional storage.

H20 x W900 x D350mm

CODE	Description	Unit	1+
EBS168SHL	Shelf	1	<b>48.50</b>

### Edubench Height Adjustable Workbench Standard



- Height adjustable bench suitable for workshop use and light engineering - 100kg load capacity.
- Adjusts from 730mm to 950mm.
- Laminated top 20mm, with removable adjusting handle.
- Other sizes available on request.
- Table size 1200mm x 600mm.

CODE	Description	Table Size	Unit	1+
EBS126HAS	Standard	1200 x 600mm	1	<b>595.00</b>

### Edubench Height Adjustable Workbench Heavy Duty



- Height adjustable bench suitable for heavy duty workshop use - 200kg load capacity.
- Adjusts from 730mm to 950mm.
- Solid beech top 27mm for durability.
- Other sizes available on request.

CODE	Description	Table Size	Unit	1+
EBS126HAH	Heavy Duty	1200 x 600mm	1	<b>1055.00</b>
EBS157HAH	Heavy Duty	1500 x 750mm	1	<b>1375.00</b>

## Wall Bins No 1



- Time proven storage system for small parts, maximising wall space.
- Four sizes in four different colours.
- Made from tough impact resistant Polypropylene.
- Manufactured in the UK.

**H50 x W100 x D90mm**

CODE	Description	Unit	20+	10+	1+
WLB101RED	No.1 - Red	1	1.50	1.65	1.85
WLB102BLU	No.1 - Blue	1	1.50	1.65	1.85
WLB103GRN	No.1 - Green	1	1.50	1.65	1.85
WLB104YEL	No.1 - Yellow	1	1.50	1.65	1.85

## Wall Bins No 3



- Time proven storage system for small parts, maximising wall space.
- Four sizes in four different colours.
- Made from tough impact resistant Polypropylene.
- Manufactured in the UK.

**H125 x W150 x D240mm**

CODE	Description	Unit	20+	10+	1+
WLB301RED	No.3 - Red	1	4.70	5.25	5.75
WLB302BLU	No.3 - Blue	1	4.70	5.25	5.75
WLB303GRN	No.3 - Green	1	4.70	5.25	5.75
WLB304YEL	No.3 - Yellow	1	4.70	5.25	5.75

## Louvre Panels



- Steel wall panels with punched louvres.
- Designed to suit the Wall Bins.

CODE	Size (H x W)	Unit	4+	1+
LWP454SML	450 x 450mm	1	18.75	22.50
LWP945VER	900 x 450mm	1	23.00	29.50
LWP459HRZ	450 x 900mm	1	23.00	29.50

## Wall Bins No 2



- Time proven storage system for small parts, maximising wall space.
- Four sizes in four different colours.
- Made from tough impact resistant Polypropylene.
- Manufactured in the UK.

**H75 x W100 x D165mm**

CODE	Description	Unit	20+	10+	1+
WLB201RED	No.2 - Red	1	2.05	2.30	2.50
WLB202BLU	No.2 - Blue	1	2.05	2.30	2.50
WLB203GRN	No.2 - Green	1	2.05	2.30	2.50
WLB204YEL	No.2 - Yellow	1	2.05	2.30	2.50

## Wall Bins No 4



- Time proven storage system for small parts, maximising wall space.
- Four sizes in four different colours.
- Made from tough impact resistant Polypropylene.
- Manufactured in the UK.

**H125 x W200 x D355mm**

CODE	Description	Unit	20+	10+	1+
WLB401RED	No.4 - Red	1	5.95	6.75	7.50
WLB402BLU	No.4 - Blue	1	5.95	6.75	7.50
WLB403GRN	No.4 - Green	1	5.95	6.75	7.50
WLB404YEL	No.4 - Yellow	1	5.95	6.75	7.50

## Storage Bins System with Panel



- A set of 24 plastic storage bins with a metal wall panel offers a quick and easy way to organise small accessories with easy access.
- Manufactured from shock-proof polymer which is resistant to mild acids, solvents and oils.
- Heavy-duty steel back panel
- Can be wall-mounted or fitted in to a van.

Contents:

- 12 Small Bins (Red): 110 x 100 x 75mm.
- 6 Medium Bins (Blue): 165 x 100 x 75mm.
- 6 Large Bins (Blue): 210 x 100 x 75mm.
- Metal Slot Wall Panel: 660 x 380 x 0.85mm.
- Mounting screws and wall plugs.

CODE	Description	Unit	2+	1+
SBS240SET	Complete Unit	1	53.50	55.50

### EduBench Systems HD Metal Bench Professional



Vices not included in the price below

- Fully welded heavy duty steel frame with a bottom shelf, height 840mm.
- Galvanised steel top turned down on both edges - width 750mm.
- Timber cored top to absorb shock and noise, providing increased stability.
- Available in 3 lengths, 1500, 1800 and 2000mm.

W750mm		EduBench SYSTEMS	
CODE	Description	Unit	1+
HDB157PRO	1500 x 750mm	1	595.00
HDB187PRO	1800 x 750mm	1	625.00
HDB207PRO	2000 x 750mm	1	675.00



Vices not included

- Fully welded heavy duty steel frame with a bottom shelf, height 840mm.
- Galvanised steel top turned down on both edges - width 900mm.
- Timber cored top to absorb shock and noise, providing increased stability.
- Available in 3 lengths, 1500, 1800 and 2000mm.

W900mm		EduBench SYSTEMS	
CODE	Description	Unit	1+
HDB159PRO	1500 x 900mm	1	635.00
HDB189PRO	1800 x 900mm	1	655.00
HDB209PRO	2000 x 900mm	1	710.00

### EduBench Systems EduBench Drawer for HD Metal Bench



- Heavy duty steel fabricated drawer.
- 450 x 470 x 240mm high.

EduBench SYSTEMS			
CODE	Description	Unit	1+
HDB450DRW	450mm	1	139.50

### EduBench Systems EduBench Cupboard for HD Metal Bench



- Made from galvanised sheet steel.
- 600 x 600mm.
- Available in 750mm and 900mm depth to suit the bench ordered.

W750mm		EduBench SYSTEMS	
CODE	Description	Unit	1+
HDB675CUB	750mm	1	99.00
HDB690CUB	900mm	1	99.00

### EduBench Mobile Heavy Duty Metal Benches

Same construction as the 'static' style but with the addition of wheel trolley. This integral trolley can lift the entire bench evenly to make the unit mobile.

With five drawer unit and matching cupboard



- Steel top fully mobile bench with retractable wheels, five drawer unit and matching cupboard.

CODE	Length x Depth (mm)	Unit	1+
HDB512SMB	1200 x 750mm	1	950.00
HDB515SMB	1500 x 750mm	1	995.00

With single cupboard



- Steel top fully mobile bench with retractable wheels.

CODE	Length x Depth (mm)	Unit	1+
HDB112SMB	1200 x 750mm	1	625.00
HDB115SMB	1500 x 750mm	1	650.00

### Dual Height Workmate



- This popular Workmate has two working heights of 595mm and 775mm and a load rating of 250kg.
- Maximum jaw opening 136mm and a jaw length of 610mm.
- Supplied with adjustable pegs to hold irregular shaped objects.
- Folds flat for compact storage and easy transport.

CODE	Description	Unit	4+	1+
BDW536DLH	Workmate	1	77.95	79.95

### Safe Step Hop-up



- Heavy duty plastic step for use as a safe, low level access platform, ideal for use in construction trades.
- Slip resistant platform and slightly tapered sides mean the step is very stable.
- Rubber inserts in the feet allow the step to be used on all types of surface.
- Can also be stacked inside each other for easy storage.
- Dimensions: 450mm x 370mm x 300mm high.
- Weight only 2kg but has a safe working load of 150kg.

CODE	Description	Unit	10+	1+
HUP300SFS	Safe Step Hop-up	1	29.95	32.95

### Aluminium Folding Hop-up



- Ideal working height of 500mm (20").
- Folding legs lock firmly in position.
- Lightweight but very sturdy aluminium folding work platform - 700mm long.

CODE	Description	Unit	4+	1+
HUP700ALU	Aluminium Hop-up	1	36.25	39.95

## Steel Trestle Handrail System 4 Metre Run



This image is an 8 metre run.

- The size 3 Trestle 4m complete Handrail System is a fully operational unit consisting of:
  - 4 x Size 3 Trestles.
  - 6 x 13ft Scaffold Boards
  - 1 x End Stop
  - 2 x Posts
  - 1x Post Swing Gate.
- This fully operational systems will allow you to work safely in accordance with regulations at a span of approximately 4m at a platform height of up to 1.688 metres.
- The system complies with the working at height regulations 2005 and is tested to BSS EN13374 and BS EN12811-1-2003 standards.
- All parts are available individually.

CODE	Description	Unit	1+
GDR400SET	Trestle Handrail System	1	<b>Call for Price</b>

## Folding Steel Step Ladder



- This folding steel step ladder has a sturdy tubular steel frame with wide steel steps. Top step height 46cm/18". Weight limit 150kg.
- Non-slip rubber feet and treads.
- Safety locking mechanism.
- The step ladder folds to a compact size.

CODE	Description	Unit	2+	1+
LAD246FST	Step Ladder	1	<b>29.95</b>	35.95

## Fibreglass Step Ladders



- Trade quality fibreglass step ladders - robust, rot resistant and rigid, whilst being lightweight.
- Non-conductive fibreglass legs ideal for use where electrical hazards exist.
- Heavy duty, non-slip, extra depth (80mm) aluminium treads.
- Heavy duty rubber feet and metal side arms prevent slips and twists.
- Built-in tool and can holder.
- Conforms to trade standard EN131-1:1993 EN131-2:1993.
- Maximum capacity 150kg.

CODE	Description	Unit	1+
LAD600FGS	4 Tread	1	<b>99.50</b>
LAD700FGS	5 Tread	1	<b>124.95</b>
LAD800FGS	6 Tread	1	<b>139.50</b>

## Zarges 3T Speedy 80 Lightweight Trade Tower



- The Zarges system can achieve various working heights up to 7 metres with different packs.
- Easy to use locking braces and guardrails.
- Stabilisers are included at 3.5 metres platform height and above.
- Folding base for speedy erection.
- Platform size is 1.41m x 0.55m.
- Available using the 3T (through the trap) assembly method.
- Scaffolding category 3 (load capability up to 200 kg / sqm) to EN 1004.

Please phone with your requirements for a quotation. Other systems are also available to order.

## Platform Steps



- These professional platform steps have a foldable aluminium construction with five rungs.
- Extra wide treads and extra-large standing platform with added grip for safety.
- Added feature of two side rails with two safety grips at the top ensures a secure balance.
- Number of treads: 5.
- Platform height: 1.02m.
- Closed length: 1.88m.
- Weight: 6.5kg.

CODE	Description	Unit	1+
LAD510PLS	Platform Steps	1	<b>175.00</b>

3D Printer - Filament	211, 212
3D Printer - Machine	211, 212
3D Printer - Scanners	213
3D Roc	267

**A**

Abrasaw	89
Abrasive Belt/Disc Cleaner	47
Abrasive Belts	47
Abrasive Cloth Rolls	47
Abrasive Cut Off Discs	50
Abrasive Discs	48, 50
Abrasive Drums	47
Abrasive Pads	48
Abrasive Rolls	47, 48, 49
Abrasive Sheets	48, 49
Abrasive Wheels	50
Abrasives	46-52
Acrylic Adhesive	55
Acrylic Balls	16
Acrylic Colourant	135
Acrylic Fixtures	16
Acrylic Hinges	16
Acrylic Inks	256
Acrylic Materials	5-16
Acrylic Paints	257, 258
Acrylic Rod	13-15
Acrylic Sanding sealer	60
Acrylic Sheets	5-13
Acrylic Solvent	55
Acrylic Square	15
Acrylic Tube	14, 15
Adhesive	55-58
Adjustable Band Clamp	169
Adjustable Spanners	106, 138
Airbrush Equipment	263
Aluminium Foil	292
Aluminium Rod	26
Aluminum Sheet	27
Anemometer	32
Angle Grinder	207
Angle Plates	172
Antifreeze	64
Anti-Splatter Spray	164
Anti-Static Cleaner	60
Anvil	165
Aprons	177
Arc Welder	164
Arc Welding Rod	162
Art & Craft Spray Adhesive	58
Art Brushes	259, 260
Artstraws	267
Auger Bits	194
Auto Switch for Extractor	221
Auto Welding Helmet	180
Aviation Compound Snips	108
Axle Material	37

**B**

Backnut Spanner	139, 144
Bag Press System	245
Baking Parchment	292
Baking Sheet	292
Baking Tins	291, 292
Ball Bearings	25
Ball Nose Slot Drill	184
Ball Pein Hammer	110, 112
Ballpoint Pens	282
Balls - Acrylic	16
Balls - Wooden	25
Balsa Adhesive	56
Balsa Wood	23
Bamboo	25
Band Clamp	169
Bandfacer	228
Banding Wheel	262
Bandsaw	234, 235, 241
Bandsaw Blades	199, 200
Basin Wrench	138, 144
Batteries	44
Battery Clips	43
Battery Holders	43
Bearing Grease	65
Bearings	204
Beech Worktop	311
Belt & Disc Cleaner	47
Belt Sander	228
Bench Grinders	229, 230
Bench Hook	168, 264
Bench Planes	91, 92
Bench Seating	305
Bench Shear	242-245
Benches	306-309, 313, 315
BenchVent	222
Bending Spring	142
Bin Liners	290
Bins	290
Bio Spirit Water Cleaner	63
Biscuit Jointer	207, 208
Biscuits - Jointing	74
Bit Holder	105
Bits - Screwdriver	103-105
Blacksmith Equipment	165
Blacksmith's Drills	191, 192
Blades - Bandsaw	199, 200
Blades - Chopsaw	196, 197
Blades - Circular Saw	196, 197
Blades - Coping Saw	88, 89
Blades - Hacksaw	90
Blades - Jigsaw	197, 198
Blades - Junior Hacksaw	90
Blades - Knife	97-99
Blades - Mitre Saw	89
Blades - Parting Tool	186, 187
Blades - Piercing Saw	89
Blades - Plane	91, 92
Blades - Planer	197
Blades - Power Fret Saw	198
Blades - Scalpel	97, 98
Blades - Scroll Saw	198
Blades - Spokeshave	92

Blind Rivets	67
Block Cutters	97, 274
Block Planes	91, 92
Block Printing Ink	264
Blocks & Line	121
Blowpipe Solder	54
Blue - Marking	84
Boat Levels	81
Bobbin Sander	230
Boiler Suit	177
Bolster	119
Bolt Cutter	110
Bolts	71, 72
Book Film	287
Boots	176
Boring Bars	187, 188
Bossing Mallet	113
Bowls	294
Box & Pan Brakes	245
Box File	285
Box Spanner	144
Brad Point Drills	194
Bradawls	103
Brass Rod	26
Brass Sheet	27
Brasso	64
Brayer Roller	264
Brazing Equipment	162
Brazing Flux	162
Brazing Hearth	246
Brazing Rods	162
Bread Knife	296
Brick Bolster	119
Brick Hammer	119
Brick Joint Raker	122, 123
Brick Jointer	122
Brick Line	121, 122
Brick Saw	120
Brick Tongs	125
Brick Trowel	122-125
Brickwork Equipment	117-125
Briwax	63
Brooms	118
Browguard & Visor	180
Brush Cleaner	134
Brushes - Art	259, 260
Brushes - Dusting	131
Brushes - Flux	131
Brushes - Glue/Paint	130, 131
Brushes - Graining	129
Brushes - Overgrainer	129
Brushes - Paperhanging	131
Brushes - Paste	131
Brushes - Stencil	131
Brushes - Sweeping	118
Brushes - Wire	135
Bucket Trowel	123, 124
Buckets	117
Builders Line	121, 122
Bulbs	42
Bush Wrench	158
Button Cells	44
Buttons - Craft	271
Buzzers	33, 41

**C**

Cabinet Scrapers	93
Cabinets	304, 310-312
Cable Cutters	107
Cable Knife	159
Cable Reel	175
Cable Ties	70
Cake Tins	291
Calculator	36, 285
Calipers	76, 79
Calipers - Dial	76
Calipers - Digital	76
Calipers - Vernier	76
Calligraphy	279
Cams	35
Can Opener	295
Canary Safety Cutter	97
Canvas - Painting	249
Card	249, 252
Carpenter's Mallet	112
Carpenter's Pencils	84
Carpenter's Square	80, 84, 85
Carry Case	266
Cartridge Paper	249, 251
Carver's Mallet	112
Carving Chisels	94-97
Carving Knives	94
Carving Tools	94-97
Cascamite Adhesive	56
Cast Iron Fittings	149
Casting Powder	267
Casting System	246
Caterpillar Track	37
Caulk	135
Cellulose Thinners	63
Cement Mixer	120
Centre Drills	191
Centre Punches	114-115
Centres - Lathe	185
Chain Vice	137
Chalk Line	80
Chalk Refills	80
Charcoal	279
Chip Carving Knives	94
Chisels - Bevel Edge	93, 94
Chisels - Carpentry	93, 94
Chisels - Carving	94-97
Chisels - Cold	119
Chisels - Mortise (machine)	200
Chisels - Sash Mortise	94
Chisels - Turning	94
Chisels - Woodcarving	94-97
Chisels - Woodworking	93, 94
Chopping Boards	291
Circle Cutter	265
Circle Template	275
Circlip Pliers	108
Circlips	74
Circular Saw	207
Circular Saw Blades	196, 197
Clamp - One-Handed	167
Clampmeter	160, 161
Clamps	167-170

Clamps - Corner/Mitre	170	Countersinks	194	Dressers	50	Files	101, 102
Clamps - Frame	169	Coverall	177	Drill - Cordless	206, 208-210	Filler	60, 61, 135
Clamps - G	170	Cramps	167-170	Drill - Hand	115	Filler - Wood	60, 61
Clamps - Hold Down	169	Cramps G	170	Drill - Mains Power	206	Filling Blades	132
Clamps - Magnetic	169	Crepe Paper	253	Drill Bits	190-194	Filling Knives	132, 133
Clamps - Quick-Action	167	Crimping Pliers	157	Drill Brushes	51	Finishing Trowel	126
Clamps - Quick-Grip	167	Crocodile Clips	33	Drill Chuck Arbors	191	First Aid Kit	181
Clamps - Sash	167	Crocodile Leads	33, 40	Drill Chuck Guard	182	Fish Slice	296
Clamps - Toggle	169	Crucible Furnace	246	Drill Chuck Key	191	Fixings	67-74
Clamps - Web	169	Crumble	40	Drill Chucks	191	Flamefast Casting System	246
Claw Hammer	111	Cupboards	299, 300, 310-312	Drill Sets	190-194	Flap Discs	50
Clay	262	Curve Rule	275	Drill Sharpener	229	Flap Wheels	51
Clay Knives	262	Cutlery	296	Drill Vice	172	Flat Bit Set	194
Clay Storage	263	Cutlery Tray	296	Drilling Machine	230-233	Flexible Curve Rule	275
Cleaning Strips	141	Cutting Compound	65	Drilling Machine Clamp	169	Flexi-Ply	22
Cling Film	292	Cutting Discs	50	Drive Centres	237	Flexi-Tub	117
Clock Faces	25	Cutting Fluid	65	Drum Sanders	47	Float	126
Clock Movements	25	Cutting Gauges	86	Drying Rack	269	Floor Scraper	120
Cloths	289	Cutting Mats	97	Drywall Rasp	127	Flux	54
Club Hammer	120	Cutting Off Blades	197	Dust Extraction Parts	220, 221	Foam Board	21
CNC Lathe	215, 217	Cutting Oil	65	Dust Extractors	218-222	Foamex	20
CNC Machinery	215-217	Cutting Plotter	214, 215	Dust Masks	180	Foil	292
CNC Milling Machine	215-217	Cyanoacrylate Adhesive	58	Dustbin	117	Foil Containers	293
CNC Router	216, 217			Dustpan & Brush	118	Folding Jig	223
CNC Router Cutters	201	<b>D</b>		Dustsheet	117	Folding Square	125
Coin Cell	44	Danish Oil	61	Dyes	61, 62	Folding Steel Rule	83, 84
Colander	296	Darby	127	<b>E</b>		Food Containers	293
Cold Chisel	119	Dead Blow Mallet	113	Ear Defenders	178	Forex	20
Cold Saw	241	Deburrer - Pipes	142	Easels	260	Forge	246
Collet Chucks	185	Deburring Tools	108	Electrical Consumables	153-156	Forging Tools	165
Combi Drill	208	Decorating Scissors	134	Electrical Tape	159	Forstner Bits	195
Combination Set	80	Decorator's Sponge	134	Electrical Testers	159-161	Frame Clamp	169
Combination Spanner	107	Decorator's Tools	129-135	Electrician's Screwdriver	158	French Curves	275
Combination Square	80	De-Ionised Water	60	Electronic Components	33-43	Fret Saw	233
Compass	77, 276	Depth Gauge Protractor	78	Electronic Project Kit	38-41	Fret Saw Blades	198
Composite Sheet	26	Desoldering Pump	53	Ellipse Template	275	Funnel	295
Compression Fittings	148	Dial Calipers	76	Emergency Stops	182	<b>G</b>	
Conduit Threading Set	156	Dial Gauge	77	Emery Cloth	47	G Cramps	170
Cone Drills	193	Dial Test Indicator	77	Enamelling Kiln	263	Garlic Press	295
Contact Adhesive	57	Diamond Dresser	50	End Mills	184	Gas Cartridge Adaptor	140
Cookery Signage	290	Diamond Polisher	227	Engineering Lathe	238-239	Gas Cylinders	140, 146
Colourant	135	Diamond Sharpeners	46	Engineer's Files	101, 102	Gas Lighter	296
Cool Melt Glue Gun	57	Dieholder	190	Engineer's Squares	78	Gas Test Gauge	137, 145
Cool Melt Glue Sticks	57	Dies	190	Engraving Laminate	19	Gas Torch	138, 146
Coolant	65	Diestocks	190	Epoxy Adhesive	55	Gas Welding Set	164
Copier Paper	287	Digital Calipers	76	Erasers	283	Gauge Screws	87
Coping Saws	88, 89	Digital Height Gauge	77	Expanding Hand Reamers	188	Gauges	86, 87
Copper/Rawhide Hammers	113	Diodes	38	Extension Leads	175, 176	Gauging Trowel	123, 124
Copper Fittings	146-148	Dip Coating System	226	Extension Pole	132	Gearbox	34
Copper Sheet	25	Disc Sander	230	Extractor Drifts	185	Gears	35
Copydex Glue	56	Distance Measurer	209	Extractor Parts	220, 221	General Purpose Oil	65
Cordless Drill	206, 208-210	Distance Sensor	41	Extractors	218, 219, 221, 222	Gents Saws	87
Cork Blocks	49	Dividers	79	Eyewash Station	181	Gesso	258
Cork Sheet	25	Door Closure	72	Eyewear	179	Glass Drills	204
Corner Blocks	121	Door Handle	72	Eze-Lap Sharpening Plates	46	Glasspaper	48, 49
Corner Bracket	69	Double Sided Tape	59	<b>F</b>		Glitter Paint	256
Corner Clamp	170	Dovetail Saws	88	Fabric Paint	256	Gloves	178, 179
Corner Profiles	120	Dowel Centres	74	Feeler Gauge	77	Glue	55-58
Corner Vice	170	Dowels	24, 74	Felt	253, 272	Glue Brushes	131
Correx	20	Drain Plug	145	Filament - 3D Printer	211, 212	Glue Containers	56
Cotton Apron	177	Drawer Insert	313	File Card Brush	101	Glue Guns	57
Cotton Bundle	272	Drawing Board	274	File Handles	100	Glue Spatulas	267
Cotton Dustsheet	117	Drawing Board Clips	275			Glue Station	57
Cotton Reels	37	Dremel Multi-Tool	210				

Glue Sticks	286	Horizontal Bar Rack	299	Knives - Stanley	99	Magnetic Bit Holder	105
Goggles	179	Hose Clip	67	Knives - Woodcarving	94	Magnetic Clamp	169
Gorilla Glue	55	Hot Melt Glue	57	Knurling Tools	187	Magnetic Retriever	174
Gouache Paint	257	Hot Melt Guns	57	Knurling Wheels	187	Magnetic Tape & Dots	36
Gouges - Carving	94-97	Hot Wire Cutter	223, 225, 227	<b>L</b>		Magnifier Lamp	174
Gouges - Turning	94	Humidity Meter	32	Laboratory Coats	177	Magnifiers	174
Grainers	129, 130	<b>I</b>		Lacquer	62	Mains Tester S/driver	104, 158
Graining Comb Set	130	Ice Cream Scoop	295	Ladders	316	Mallets	112, 113
Granite Surface Plates	76	Illuminated Magnifiers	174	Ladle	165	Manikin	266
Granulator	225	Immersion Spanner	139, 143	Laminating Pouches	285	Manometer	137, 145
Graphite Crayon	279	Impact Drill	206	Lampholder	42	Marbling Ink	256
Grater	295	Impact Driver	208	Lamps	42	Marker Pens	279, 282
Gratnells Inserts	302, 304	Impact Driver Bit	104	Lamps Base	42	Marking Blue	84
Gratnells Runners	304	Impeller	35	Laser Cutters	213, 214	Marking Fluid	84
Gratnells Units	301-304	Indexable Lathe Tools	187	Laser Levels	82	Marking Gauges	86, 87
Gratnells Tray	302	Indexable Tips	187	Latches	71, 72	Marking Knives	86
Gratnells Trolleys	303, 304	India Oilstones	46	Lathe Centres	185	Marking Stamps	115
Gratstack	301	Injection Moulder	227	Lathe Chucks	185	Masking Tape	59
Grease	65	Ink - Acrylic	258	Lathe Tool Tips	187	Masonry Drills	204
Grease Gun	65	Ink - Block Printing	264	Lathe Toolposts	186	Matchsticks	25, 268
Greyboard	265	Ink - Marbling	256	Lathe Tools	185-188	MDF Model Bases	25
Grinders	207, 229, 230	Ink Roller	264	Lathes - CNC	215, 217	MDF Sealer	61
Grinding Wheels	50	Inking Tray	260	Lathes - manual	237-239	MDF Sheets	22, 25
Grouting Float	128	Inkjet Paper	287	Lead Free Pewter	26	MDF Wheels	25
Guillotine	242, 274	Inside Caliper	79	Lead Free Solder	53	Measuring Jug	294
<b>H</b>		Inside Micrometers	76	Leads	33	Measuring Spoons	294
Hacksaws	89, 90	Interfacing	272	Leak Detection Fluid	138	Measuring Tapes	82, 83
Hammerite Paint	58	Isolator Switch	182	Leather Aprons	177	Memory Stick	276
Hammers	110-113, 119, 120	<b>J</b>		LED Holder	42	Mesh Locker	305
Hand Cleaner	64, 180	Jab Saw	127	LED Tealight	268	Mesh Wallet	286
Hand Countersink	194	Jack Planes	91, 92	LEDs	42	Metal Bench	315
Hand Drill	115	Japanese Saw	87	Leg Vice	165	Metal Rods	26
Hand Laps - Diamond	46	Jenny Caliper	79	Lemon Oil	62	Metal Saws	241
Hand Mixer	292	Jigsaw Blades	197, 198	Lettering Stencils	275	Metal Shears	242-245
Hand Sanitiser	182	Jigsaws	206-209	Levels	80-82, 145	Metal Sheets	27
Hand Sheet Metal Punch	114	Joiners Hammer	110, 111	Lever Arch File	285	Metal Workers Vices	171
Hand Towels	289	Jointer Plane	92	Light Meter	32	Metalcraft	243, 244
Hand Vice	170	Jointing Biscuits	74	Lightboxes	274	Metals	26, 27
Hardpoint Saws	88	Jointing Dowels	74	Line & Pins	122	Methylated Spirit	63
Hawk	125, 126	Jubilee Clip	67	Line Benders	223	Micrometers	76
Haz Substance Cabinet	304	Jug	294	Line Blocks	121	MIG Welders	163, 164
Heat Resistant Mat	141	Juice Extractor	295	Line Pins	122	MIG Wire	162
Heat Triangle	291	Jumper Wire Kit	33	Lining Paper	134	Mild Steel	26, 244
Heatgun	206, 209, 210	Junior Hacksaw Blades	90	Lino Cutters	264	Milling Collets & Chucks	185
Height Adj Workbench	313	Junior Hacksaws	89	Lino Printing Blocks	265	Milling Cutters	184
Height Gauge	77	<b>K</b>		Linseed Oil	62	Milling Machine	239, 240
Helmet - Safety	176	Kettle	293	Lip & Spur Drills	194	Mini Bolt Cutter	110
Helmet - Welding	180	Keyed Chuck	191	Liquid Latex	267	Miniature Rotary Tools	51
Hex Keys	105	Keyless Chuck	191	Loaf Tin	293	Mirlon Abrasive	48
High Impact Polystyrene	17, 18	Keyrings	25	Lockers	305	Mitre Clips	168
Highlighters	282	Keys - Hex	105	Locking Pliers	109	Mitre Kit	58
Hinges	16, 71	Keys - Torx	105	Locks	71, 72	Mitre Saw Blades	89
HIPS	17, 18	K'Nex	29, 30	Lollipop Sticks	268	Mitre Saws - Hand	89
Hi-Vis	176	Knife Blades	97-99	Long Tape Measure	82	Mitre Saws - Power	209
Hole Punch	284	Knife Sharpener	296	Louvre Panel	313, 314	Mitre Squares	85
Holesaw Arbors	195	Knives - Chip Carving	94	Low Odour White Spirit	63	Mixer - Cement	120
Holesaw Sets	137, 195	Knives - Cookery	296	Lubricants	65	Mixers-Food	292
Holesaws - Individual	196	Knives - Cutlery	296	<b>M</b>		Mixer - Plaster	127
Honing Guide	46	Knives - Marking	86	Machinable Plastic Wax	27	Mixing Board	120
Honing Oil	46	Knives - Putty	133	Machine Reamers	188	Mixing Paddle	127, 133
Hook & Loop Tape	286	Knives - Retractable	98, 99	Machine Vice	172	Mobile Storage System	310
Hook and Loop Straps	70	Knives - Snap-Off	99	Magnetic Bases	77	Model Bases	25
Hop-Ups	315					Model Maker's Vice	171
						Modeling Wire	265

Modelling Board	21	Paint Blocks	256, 257	Plan Chest	275	Pump Oil Can	65
Modelling Foam	21	Paint Brushes	130, 131	Plane Blades	91, 92	Punched Pockets	286
Modelling Sticks	25, 268	Paint Kettle	133	Planer Blades	197	Punch Pliers	114
Modelmaker's Files	101	Paint Pen	279	Planer Thicknesser	235, 236	Punch Set	114, 115
Modesty Blocks	69	Paint Roller & Tray	132	Planers	208	Punches	114, 115
Mop Bucket	290	Paint Scrapers	132, 133	Planes	91, 92	Push Pin Magnetic	115
Mops	290	Paint Scuttle	133	Plasma Cutter Set	163	Push Sticks	235
Mops - Polishing	52	Painting Equipment	129-135	Plastazote	19	Putty Knives	133
Morse Taper Sleeves	185	Paints Oil	258	Plasterers Darby	127	PVA Adhesive	56
Mortar Board	120	Palette Knives & Scrapers	261	Plastering Equipment	125-127	PVA Glue - Washable	267
Mortise Chisel Sharpener	200	Pallet Truck	182	Plastering Trowel	125, 126	PVC Foam Sheets	20
Mortise Chisels & Bits	200	Palm Carving Tools	94	Plasters	181	PVC Roll	21
Mortise Gauges	86, 87	Palm Sander	207, 209	Plastic Adhesive	58	PVC Sheets	20
Mortiser	233	Panel Pins	68	Plastic Dip Coating	226	Pyrography Set	52
Motors	34, 35	Panel Saw - Hand	88	Plastic Forming	223-227		
Mount Board	254	Paper	249-251, 287	Plastic Mirror	25	<b>Q</b>	
Mouse	287	Paper Fastener	286	Plastic Wheels	34, 37, 41	Quiche Tins	291
Muffin Tray	291	Paper Towels	289	Platform Steps	316	Quick Square	84
Mug Press	280	Paperhanging Brush	131	Pliers	107-110, 157	Quick-Action Clamps	167
Mugs	280	Paraffin Wax Pellets	261	Plug Cutters	194		
Multi Purpose Oil	65	Parallel Sets	172	Plugging Chisel	119	<b>R</b>	
Multi Tool	206	Parcel Tape	59	Plumb Bob & Line	134	Racing Car Blank	21
Multi-Angle Vice	170	Parting Tool Blades	186	Plumbers Solder	146	Racking	298, 299
Multi-Angle Wrench	144	Parting Tool Holder	186	Plumbing Equipment	136-146	Radiator Spanner	143
Multimeter	157, 159	Parting Tools	186-188	Plumbing Consumables	146-152	Radius Gauge	78
<b>N</b>		Pasta Machine	295	Plywood	22	Rafter Square	84, 125
Nail Driver	115	Pastels	257	Pneumatic Kit	36	Rags	60
Nail Punches	115	Pastel Fixative	261	Pneumatic Wheels	182	Rasps	100, 101, 127
Nails	68, 72	Pasting Table	134	Pointing Trowel	122-125	Ratchet Handle	106
Needle Files	101	Pastry Brush	294	Polishing Compound	51	Ratchet Web Clamps	169
Needles	272	Pastry Cutters	291	Polishing Cream	46	Ready Mixed Poster Paint	255
Neoprene Sheet	254	PAT Tester	161	Polishing Machines	229	Reamers	188
Notcher	245	PCB Engraver	217	Polishing Mops	52	Rebate Planes	91, 92
Note Pad	287	Peeler	295	Polycarbonate Sheet	19	Reduced Shank Drills	191, 192
Number Stamps	115	Pencil Compass	78, 276	Polymorph	27	Refuse Sacks	117
Nuts	69, 70, 73	Pencil Sharpener	283	Polypropylene Rope	70	Repositionable Note	285
<b>O</b>		Pencils	84, 277, 279	Polypropylene Sheet	20	Resin Bonded Belts	47
Oak Veneered MDF	22	Pens	277, 282, 283	Polystyrene Cutter	223, 225, 227	Resin Bonded Discs	50
Oil - Finishes	61, 62	Perforated Tool Panel	313	Polyurethane Adhesive	55	Resistors	38
Oil - Lubricants	65	Perspex - See Acrylic Sheets		Polyurethane Varnish	61	Respirator	180
Oil Can	65	Pestle & Mortar	295	POP Roc	267	Re-threading Tool	158
Oil Paints	258	PETG Sheets	19, 21	Poplar Ply	22	Retractable Knives	98, 99
Oil Pastels	257	Pewter	26	Portfolio Case	266	Re-useable Clay	268
Oil Spill Kit	177	Pfeil Carving Tools	94-97	Posca Pen	277	Revolving Centres	185
Oilstone Box	46	Piano Hinges	71	Poster Paint	255	Revolving Punch Pliers	114
Oilstones	46	Piercing Saw Blades	89	Potato Masher	296	Ring Binder	285
Olive Remover	142	Piercing Saws	89	Pottery Equipment	262	Rivet Snap	67
Olives	148	Piggyback Vice Mount	310	Pottery Tools	262	Riveter	67
One-Handed Clamp	167	Pillar Drill	230-233	Pottery Wheel	262	Rivets	67, 73, 244
O-Rings	74	Pilot Drill	195	Power Fretsaw	233	Roller Table	242
Outside Caliper	79	Pin Hammers	110, 111	Power Fretsaw Blades	198	Rollers - Decorators	132
Outside Micrometers	76	Pin Punches	114	Power Supply DC	32	Rolling Pin	262, 294
Oval Nails	68	Pincers	107	PPE	176-179	Roll'n'Park System	312
Oven	225	Pins	272	Pressure Test Equipment	137, 138, 145	Roofing Square	84, 125
Oven Gloves	289	Pinking Shears	271	Profile Cutter	225	Rope	70
<b>P</b>		Pipe Bender	136, 139	Pronged Nut	70	Rosin Free Solder	53
Padlocks	174	Pipe Bender Ext Handle	142	Propellers	35	Rotary Accessory Kit	51
Paint - Art	255-258	Pipe Cleaners	267	Protective Clothing	176, 177	Rotary Brushes	51
Paint - Fabric	256	Pipe Cutters	136, 139-142	Prototyping Board	33	Rotary Table	172
Paint - Glitter	256	Pipe Freezing Kit	138, 140	Protractor	77, 78, 276	Rotary Tool	210
Paint - Glitter	256	Pipe Slicer	136	PTFE Tape	146	Rotary Wire Brushes	51
Paint - Gouache	257	Pipe Threader	136	Pulleys	25, 35	Roundhead Screws	68
Paint Acrylic	258, 259	Pipe Vice	136, 137	Pump Dispenser	56	Router Cutter Arbors	204
		Pipe Wrench	136, 139			Router Cutter Bearings	204



Router Cutter Sets	51, 204	Scutch Combs	119	Soldering Iron Stand	53	Superglue	58
Router Cutters	201-204	Scutch Hammer	119	Soldering Paste	54	Superglue Activator	58
Router Planes	91	SDS Drill	204	Soldering Station	53	Surface Gauge	78
Routers	206-208	Sealant Gun	64	Soluble Oil	65	Surface Plates	76
Rubber Bands	287	Sealants	64	Sound Meter	32	Surforms	100
Rubber Hose	137	Seam Roller	134	Spanners	106, 107, 143, 144	Swage Block	165
Rubber Mallets	113	Security Bit Set	104	Spatula	294	Swann Morton Knives	97, 98
Rubber Sheets	26	Self Locking Pliers	109	Spatulas - Glue	267	Switches	40, 41, 43
Rubbers	283	Self-Adhesive Discs	48	Speakers	33	Syringe System	55
Rubble Sacks	117	Self-Tapping Screws	69, 73	Speedskim	127		
Rulers	276, 285	Set Squares	276	Spirit Levels	80-82	<b>T</b>	
Rules	83, 84	Sewing Machines	271	Spokeshaves	92	T-Square	275
Runners	304	Sharpener - pencil	283	Sponge	128, 130, 134	Table Saw	236
		Sharpening Steel	296	Spray Booth	222	Tablecloth - Plastic	261
<b>S</b>		Sharpening Stones	46	Spray Bottles	289	Tack Cloths	60
Sack Truck	182	Shavehook	133	Spray Mountable Adhesive	58	Tail Slide Assembly	167
Sacks	117	Shaver Tool	100	Spray Paint	254	Tap & Die Sets	190
Safety Clothing	176, 177	Shears - Metal	242-245	Spraying Table	269	Tap Spanner Set	138, 139
Safety Eyewear	179	Sheet Folder	242-245	Spring Assortment	74	Tap Wrenches	190
Safety Eyewear Storage	179	Sheet Joiners	21	Spring Clamp	167	Tape - Adhesive	59, 287
Safety Hand Guard	264	Sheet Metal	27	Square - Combination	80	Tape - Electrical	159
Safety Pins	271	Sheet Metal Cutter	108	Square - Engineering	78	Tape Dispenser	59
Safety Rule	83	Sheet Metal Equipment	242, 245	Square - Large Steel	125	Tape Measures	82, 83, 272
Safety Signs	181	Sheet Metal Punch	114	Square - Set	276	Taper Shank Drills	192
Safety Spectacles	179	Sheet Press	225	Square - Woodworking	84, 85	Taping Knife	132
Sandbag	165	Sheet Rack	299	Stanley Knives	99	Tapping Compound	65
Sander	206, 207, 209	Shelf Brackets	71	Staple Guns	74	Tapping Drills	190
Sanding Block	49, 134	Shoulder Planes	91, 92	Staple Remover	284	Taps	189
Sanding Discs	48, 50	Shovel	118	Staplers	284	Tarpaulin	176
Sanding Drums	47	Sieve	165	Staples	74, 284	TCT Circular Saw Blades	196, 197
Sanding File	47	Sifter	296	Steel Hinges	71	TCT Planer Blades	197
Sanding Sealer	60, 62	Signs	181, 290	Steel Modeling Wire	265	Tea Light Holder	244
Sandpaper	48, 49	Silhouette Cameo	215	Steel Rod	26	Tea Towels	289
Sash Cramps	167	Silicone Sealant	64	Steel Rules	83	Teak Oil	62
Sash Mortise Chisels	94	Silicone Spray	64	Steel Wool	60, 141	Tealight	268
Satin Mops	52	Silver Solder	54	Stencil Brush	131	TechCard	31
Saw - Japanese	87	Silver Steel	26	Step Drills	193	Tee Square	275
Saw Screws	88	Sketch Books	248, 250, 251	Step Ladder	316	Tenon Saws	87, 88
Sawbench	236	Skewer	296	Steps	316	Test Nipples	137
Saws - Hand Tools	87-90, 127	Skin Safety Products	180	Sticky-Off	64	Test Plug Set	145
Scale Rule	83	Skip	120	Stillson Wrench	136, 139	Thermochromic Materials	27
Scales	294	Slaters Hammer	112	Stitched Mop	52	Thermoforming Centre	227
Scalpel Blades	97, 98	Sledge Hammer	120	Stockinette Rolls	133	Thermometer	296
Scalpels	97, 98	Sleeves - Taper	185	Storage	298-315	Thermometer - Infrared	32
Scanner - 3D	213	Sliding Bevels	84, 85	Storage Bin	314	Thicknessers	235, 236
Scissors	134, 284, 295	Sliding Dieholder	190	Storage Lockers	305	Thinners	63
Scrapers - Cabinet	93	Slipstones	46	Storage Racks	298, 299	Thread - Polyester	272
Scrapers - Decorator's	133	Slot Drills	184	Storage Trays	302	Thread Cutting Oil/Paste	65, 136
Scrapers - Floor	120	Smart Materials	27	Straight Edge	83, 127	Threaded Rod	70
Screw Cutting Gauge	78	Smoke Pellet	138	Stretched Canvas	249	Threader Set	156
Screw Eyes	67	Smoothing Planes	91, 92	Stretcher Plates	71	Threadlocker	54
Screw Gauges	78	Snap-Off Knives	99	String	59	TIG Welders	163, 164
Screw Hooks	67	Soap	289	Strip Heater	223	Tile Cutter	128
Screw Pitch Gauge	78	Socket Sets	106	Stripboard	33	Tile Spacers	128
Screwdriver Bits	103-105	Soft Vice Jaws	170	Strops	46	Tile Sponge	128
Screwdriver Ratchet	103	Softener Brush	129	Studding	70	Tiling Equipment	128
Screwdrivers	103-105	Solar Cells	35	Styrofoam	21	Tiling Trowel	128
Screws	68, 69, 72, 73	Solar Charger Panel	30	Subject Dividers	285	Timber	23
Scribers	79	Solar Kits	30	Sublimation Ink	280	Timer	294
Scroll Former	243, 244	Solder	53, 54, 146	Sublimation Paper	280	Timer - Electronic	38
Scroll Saw	233	Solder Stand	53	Sublimation Presses	279, 280	Tinsnips	108
Scroll Saw Blades	198	Soldering & Brazing Pad	141	Sublimation Printers	280	Tip Tinner	54
Scumble	135	Soldering Equipment	52-54	Sugar Paper	249	Tipping Skip	120
Scutch Chisels	119	Soldering Flux	54, 146	Sugar Soap	135	Tips - Indexable	187

Tissue Paper	253	Vernier Height Gauge	77	Wire Nails	68
Titebond Adhesive	55	Vernier Protractor	77	Wire Netting	266
Tjanting Tool	261	Vertical Bar Rack	299	Wire Rope	72
Toggle Clamps	169	Vice Jaws	170	Wire Rope Cutters	107
Tongs - Blacksmiths	165	Vices	136, 137, 170-172	Wire Strippers	106-108
Tongs - Brick	125	Vinyl Cutter	214, 215	Wire Wool	60, 141
Tongs - Food	295	Vinyl Sheet	215	Wonder Wipes	60
Tool Bags	298	Vinyl Tape	59	Wood	22-25
Tool Cabinet	310-312	Viper Router Cutters	201-204	Wood Dyes	61, 62
Tool Clips	69	Visor	180	Wood Filler	60, 61
Tool Hooks	313	Voltage Sensor	160, 161	Wood Finishes	60-63
Tool Tray	313	Voltmeter	160, 161	Wood Rasps	100, 101
Toolbits	185			Wood Stains	61, 62
Toolboxes	298	<b>W</b>		Wood Veneer	23
Toolgrinder	229	Wad Punch Set	114	Woodcarving Chisels	94-97
Toolmakers Clamp	169	Wadding	272	Woodcarving Knives	94
Torch - Gas	138	Wall Bin	314	Woodcarving Tools	94-97
Torches	174	Wall Plugs	67, 69	Wooden Balls	25
Torpedo Level	81	Wallpaper Brush	131	Wooden Dowels	24
Torx Keys	105	Washable Glue	267	Wooden Pulleys	25
Towel Dispenser	289	Washers	70	Wooden Spoon	294
Towels	289	Water Flow Measure	138, 145	Wooden Squares	24
Tracing Paper	251	Water Mixable Oil Paints	258	Wooden Wheels	25
Traffic Cone	176	Water Pot	261	Woodscrews	68
Trailing Lead	176	Water Pressure Gauge	137, 145	Woodturning Lathe	237
Trammel Heads	78	Watercolour Paint	256, 257	Woodturning Tools	94
Transformers & Leads	176	Waterproof Abrasive	48, 49	Woodworking Vices	171
Trestle Handrail System	316	Waterpump Pliers	108, 140	Workmate	315
Trimmer - Paper	274, 285	Wax & Clay Modelling Kit	262	Worktop - Beech	311
Trimming Machine	225	Wax Melting Pot	261	Wrecking Bar	112
Trolley Frame	313	Wax Modelling Tools	262		
Trolley Shelf	313	Wax Paraffin	261	<b>Y</b>	
Trowels	122-126, 128	Wax Polish	63	Yacht Varnish	61
Try Plane	92	WD-40	65	Yarn	272
Try Squares	85	Web Clamps	169		
Tube Bender	136, 139	Welders	162-164		
Tube Connectors	36	Welders Chipping Hammer	112		
Tube Cutters	136, 139-142	Welding Clamps	109		
Tuck Pointers	123, 124	Welding Curtain	164		
Turps	63	Welding Equipment	162-164		
Tweezers	115	welding Extractor	221		
		Welding Gauntlets	179		
<b>U</b>		Welding Helmet	180		
UHU Adhesive	56	Welding Rods	162		
Underbench System	311	Welding Torches	164		
Unstitched Mop	52	Wet Floor Sign	290		
Urko Clamps	168	Wetstone Grinder	228		
USB Memory Stick	276	Wheel Dressers	50		
USB Power Lead	38	Wheelbarrow	118		
Utility Bar	112	Wheelie Bin	118		
		Wheels - Knurling	187		
<b>V</b>		Wheels - Plastic	34, 37, 41		
Vacuum Cleaner	219	Wheels - Pneumatic	182		
Vacuum Formers	224, 227	Wheels - Wooden	25		
Vacuum Forming Sheets	17, 18	Whisk	294		
Valve Spanner	143	White Spirit	63		
Varnish	61	White Tack	286		
VDE Pliers	157	Whiteboard Markers	282		
VDE Screwdrivers	158	Wing Nuts	70		
Vee Blocks	172	Wipe Dispenser	289		
Veneer	23	Wipe-Out Tool	130		
Veneer Pins	68	Wipes	60, 182, 289		
Vent Sizing Gauge	145	Wire	33, 266		
Vernier Calipers	76	Wire Brushes	51, 135		

## Workshop Fit-out and Refurbishments

### Workshop Design and Installation

We have extensive experience of designing and installing workshops for both new-build and refurbishment projects. Former contract work has included design advice and installations for some of the foremost construction and educational furniture companies.

We can provide knowledgeable advice on the layout and arrangement of workshops to ensure that they are cost-effective, efficient and safe – and, importantly, meet all legal and best practice requirements. Our installation team includes fully qualified engineers holding CSCS cards and are covered by comprehensive public liability insurance.



- Design and installation comply with the Health and safety at work Act.
- Electrical installation work in accordance with the current regulations.
- Our services include extraction, work benches and storage.
- On a tight budget? You may wish to consider buying refurbished machinery.
- Should visuals be required we can provide accurate 2D layouts, followed by high quality 3D imagery to prevent costly errors.

We know these projects can be complex and time-consuming, but we seek to provide our assistance and advice throughout the whole project – this combined with excellent after-sales service ensures a smooth prompt fulfilment.



## Refurbishment, Upgrade and Repair

Older high quality equipment may get written-off due to current safety regulations. Typically these have plenty of life left due to their light use and we can often upgrade them with new guarding or electrics – please contact us for an assessment.



## Annual Health and Safety Inspection

We can help ensure that your workshops are running safely, smoothly and in compliance with relevant regulations and best practice standards with our annual servicing and inspection packages.

Comprehensive, written reports are provided for each machine inspected as part of this service. In accordance with the requirement of BS4163 - 2014 and the recommendations of the National Association of Inspectors and Advisers in Design & Technology, The Management of Health and Safety at Work Regulations 1999, POWER Regulations 2014.



## LEV (Dust Extraction) Annual Inspection, through examination and report of LEV plant

We can design, service, test and certify dust extraction (LEV) systems to ensure that they meet relevant COSHH requirements.

Our technical engineer holds P601, P602 and P603 proficiency certificates in LEV design and testing from the British Occupational Hygiene Society (BOHS).

Wood dust extraction system and heat/fume extraction plant in accordance with the requirements of the COSHH Regulations 2002 (amended to 2004) Regulation 9.1 and HSE CoP HSG54/37 BOHS recommendations.



## Terms & Conditions

Terms are 30 days to approved accounts. Prices are subject to VAT at standard rate. The risk of damage or loss to the goods shall pass to the buyer when the goods are collected or, if the goods are to be delivered, at the time of delivery. Any goods returned for credit may be liable to a restocking charge of up to 25%.

Notwithstanding delivery and the passing of risk in the goods, the property in the goods shall not pass to the buyer until the seller has received cash or cleared funds in full payment of the price of the goods. We reserve the right to claim from the buyer all reasonable expenses incurred in collection of overdue monies. We reserve the right to charge the buyer 2% per month interest on all overdue debts.

Until such time as the property in the goods passes to the buyer, the buyer shall hold the goods as the seller's fiduciary agent and bailee. He shall ensure that the goods are kept separate from those of the buyer and from those of third parties and if resold or used in the ordinary course of business he shall account to the seller for the proceeds of sale or otherwise of the goods. The seller retains the right, until such time as the property in the goods passes to the buyer to deliver up the goods to the seller and if the buyer fails to do so, to enter the premises of the buyer to repossess the goods.

Prices will be maintained for as long as possible but may be altered without notice.

The company has made every effort to ensure that the text and photographs are accurate and are a true representation at the time of going to press, but due to the limitations of photography and four colour printing, slight variations in colour may occur. Should a customer's decision to purchase a product be influenced by the given text or photography they should verify the detail of the product with the company prior to purchase.

The company's policy is one of continuous improvement and they reserve the right to alter specifications and substitute product without notice.

The company cannot accept any liability in respect of any errors or omissions, or for loss or damage, malfunction or consequential loss from reliance upon the text or photography. No part of this publication may be reproduced, stored in a retrieval system or transmitted in any form or by any means without the prior written permission of the company.



Langley House | Station Road  
Standon | Hertfordshire | SG11 1QN

T 01920 824770

F 01920 824773

E sales@tilgear.info

[www.tilgear.info](http://www.tilgear.info)

For international calls use  
++44 (0) 1920 824770

## WORKSHOPS | INSTALLATION | SERVICING



## TOOLS | MATERIALS | EQUIPMENT

Supplying Educational and Training Establishments for over 50 years

Langley House, Station Road, Standon, Hertfordshire SG11 1QN  
International: +44 (0) 1920 824770 Fax: 01920 824773

[www.tilgear.info](http://www.tilgear.info)